

PRINT DIST  
 DW

THIS INFORMATION IS CONFIDENTIAL AND IS DISCLOSED TO YOU ON CONDITION THAT NO FURTHER DISCLOSURE IS MADE BY YOU TO OTHER THAN AMP PERSONNEL WITHOUT WRITTEN AUTHORIZATION FROM AMP (TAIWAN) LTD. DIMENSIONS IN MILLIMETERS. DO NOT SCALE PRINT.

METRIC

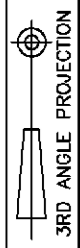

NUMBER  
C-1734006

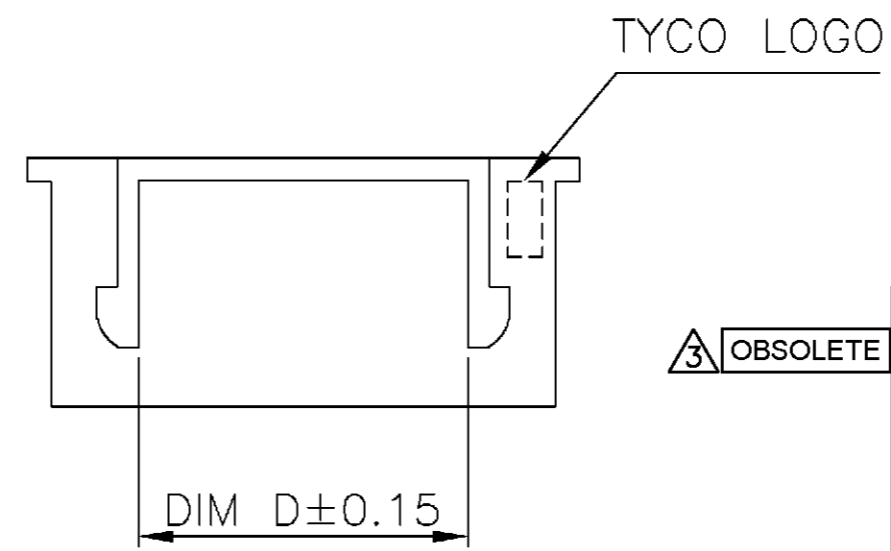
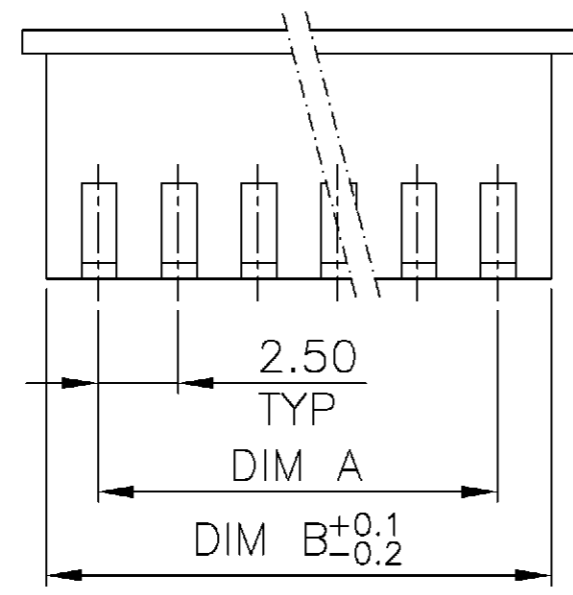
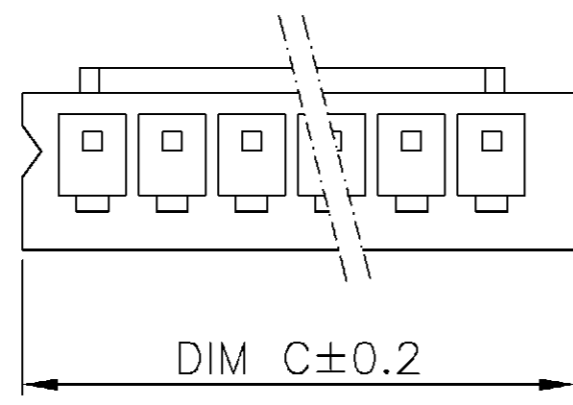
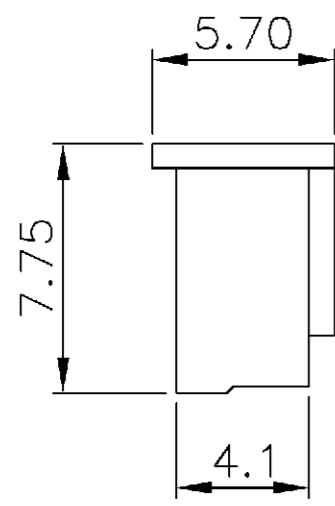

NOTE:

1. MATERIAL :  
HOUSING : THERMOPLASTIC, UL 94V-0,  
WHITE COLOR.

2. APPLY TERMINAL PART NO: 1734007-1.

**3** OBSOLETE PARTS: OBSOLETE CIS STREAMLINING PER D.RENAUD/D.SINISI

<b>3</b> OBSOLETE	42.3	40.8	37.50±0.15	16	1-1734006-6
	39.8	38.3	35.00±0.15	15	1-1734006-5
	37.3	35.8	32.50±0.15	14	1-1734006-4
	34.8	33.3	30.00±0.15	13	1-1734006-3
	32.3	30.8	27.50±0.15	12	1-1734006-2
	29.8	28.3	25.00±0.12	11	1-1734006-1
	27.3	25.8	22.50±0.12	10	1-1734006-0
	24.8	23.3	20.00±0.12	9	1734006-9
	22.3	20.8	17.50±0.10	8	1734006-8
	19.8	18.3	15.00±0.10	7	1734006-7
	17.3	15.8	12.50±0.10	6	1734006-6
	14.8	13.3	10.00±0.08	5	1734006-5
	12.3	10.8	7.50±0.08	4	1734006-4
9.8	8.3	5.00±0.05	3	1734006-3	
7.3	5.8	2.50±0.05	2	1734006-2	
DIM. C	DIM. B	DIM. A	CIRCUITS	PART NUMBER	

O1	REVISED	ECO-09-026495	KK AEG	28NOV 09
O	FIRST RELEASED	FZ00-0057-04	OH SH	16APR 2004
LTR	REVISION RECORD	ECN	DWN CHK	DATE

DIMENSION : 0 PLC ± 1 PLC ±0.25 2 PLC ±0.15 3 PLC ±0.05 ANGLES ±		DWN O. HU 16-APR-2004 CHK S. HOU 16-APR-2004		<b>tyco</b> TYCO HOLDINGS (BERMUDA) <b>Electronics</b> VII LTD. TAIWAN BRANCH	
MATERIAL  SEE NOTE		APVD T. KE 16-APR-2004 PRODUCT SPEC 108-57467		NAME  HPI 2.5 MM PITCH, SHROUDED, HOUSING	
FINISH  SEE NOTE		QUALIFICATION TEST REPORT 501-57537 WEIGHT		LOC DW A <sub>3</sub>	DRAWING NO C-1734006
				SHEET 1 OF 2	REV O1

PRINT DIST  
 DW

THIS INFORMATION IS CONFIDENTIAL AND IS DISCLOSED TO YOU ON CONDITION THAT NO FURTHER DISCLOSURE IS MADE BY YOU TO OTHER THAN AMP PERSONNEL WITHOUT WRITTEN AUTHORIZATION FROM AMP (TAIWAN) LTD. DIMENSIONS IN MILLIMETERS. DO NOT SCALE PRINT.

METRIC

NUMBER C-1734006

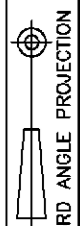
 3RD ANGLE PROJECTION

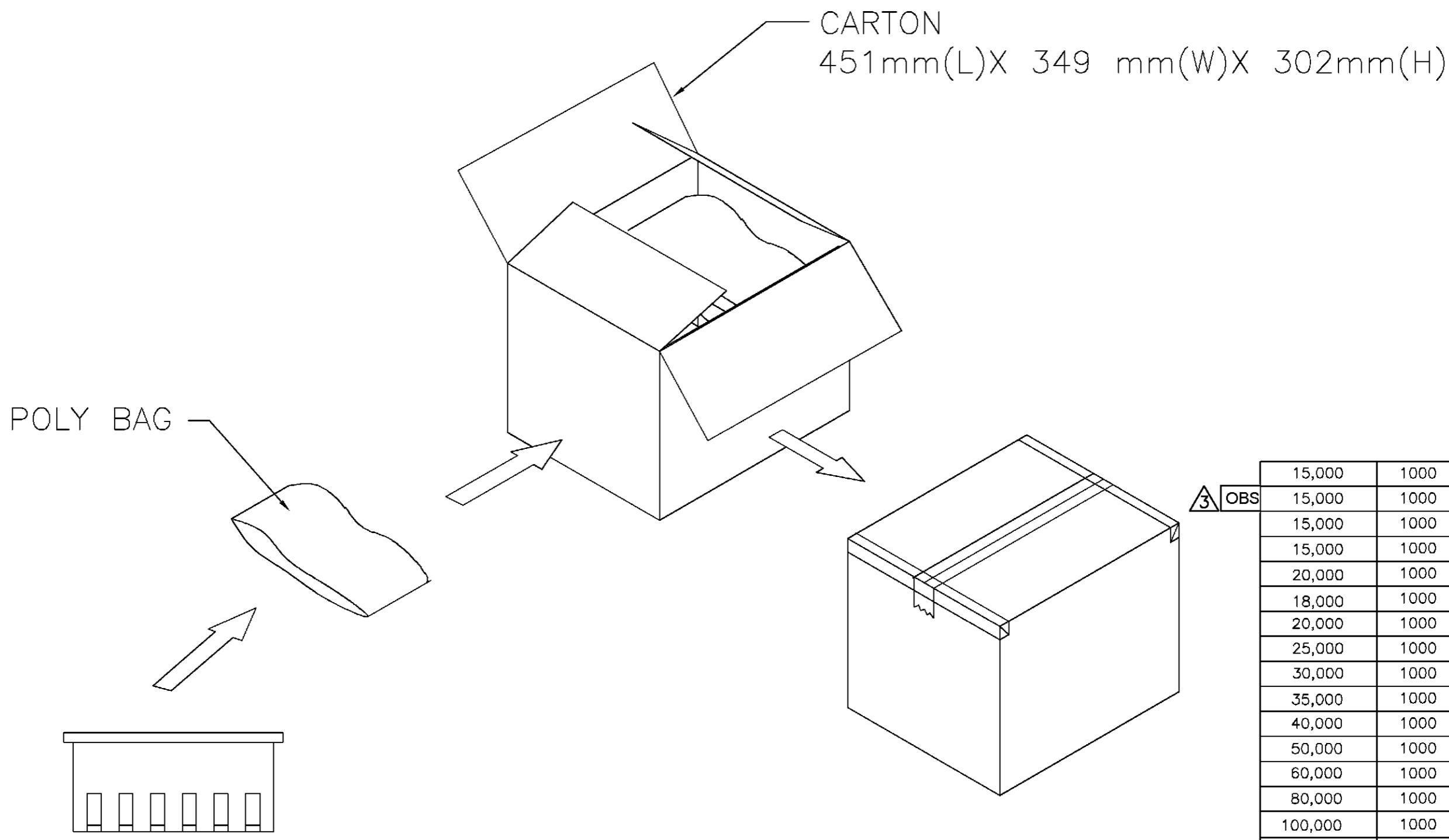

	15,000	1000	1-1734006-6
3 OBS	15,000	1000	<del>1-1734006-5</del>
	15,000	1000	1-1734006-4
	15,000	1000	1-1734006-3
	20,000	1000	1-1734006-2
	18,000	1000	1-1734006-1
	20,000	1000	1-1734006-0
	25,000	1000	1734006-9
	30,000	1000	1734006-8
	35,000	1000	1734006-7
	40,000	1000	1734006-6
	50,000	1000	1734006-5
	60,000	1000	1734006-4
	80,000	1000	1734006-3
	100,000	1000	1734006-2
	APQ (PCS/CARTON)	PPQ (PCS/BAG)	PART NUMBER

DIMENSION : 0 PLC ± 1 PLC ± 2 PLC ± 3 PLC ± ANGLES ±		DWN O. HU 16-APR-2004	<b>tyco</b> TYCO HOLDINGS (BERMUDA) <b>Electronics</b> VII LTD. TAIWAN BRANCH	
MATERIAL  SEE NOTE		CHK S. HOU 16-APR-2004	NAME  HPI 2.5 MM PITCH, SHROUDED, HOUSING	
FINISH  SEE NOTE		APVD T. KE 16-APR-2004	PRODUCT SPEC	LOC DW A <sub>3</sub> DRAWING NO C-1734006 REV 01
		APPLICATION SPEC	WEIGHT	SCALE -- SHEET 2 OF 2

	SEE SHEET 1.			
LTR	REVISION RECORD	ECN	DWN	CHK
			DATE	