



## 10-/8-BIT, 3-MSPS, MICRO-POWER, MINIATURE SAR ANALOG-TO-DIGITAL CONVERTERS

### FEATURES

- 3-MHz Sample Rate Serial Device
- 10-Bit Resolution – ADS7884
- 8-Bit Resolution – ADS7885
- Zero Latency
- 48-MHz Serial Interface
- Supply Range: 2.7 V to 5.5 V
- Low Power Dissipation:
  - 6.8 mW at 3-V  $V_{DD}$ , 2.5 MSPS
  - 15 mW at 5-V  $V_{DD}$ , 3 MSPS
- $\pm 0.3$  LSB INL,  $\pm 0.3$  LSB DNL – ADS7884
- $\pm 0.15$  LSB INL,  $\pm 0.1$  LSB DNL – ADS7885
- 61.7 dB SINAD, –81 dB THD – ADS7884
- 49.8 dB SINAD, –68 dB THD – ADS7885
- Unipolar Input Range: 0 V to  $V_{DD}$
- Powerdown Current: 1  $\mu$ A
- Wide Input Bandwidth: 30 MHz at 3 dB
- 6-Pin SOT23 Package

### APPLICATIONS

- Base Band Converters in Radio Communication
- Motor Current/Bus Voltage Sensors in Digital Drives
- Optical Networking (DWDM, MEMS Based Switching)
- Optical Sensors
- Battery Powered Systems
- Medical Instrumentations
- High-Speed Data Acquisition Systems
- High-Speed Closed-Loop Systems

### DESCRIPTION

The ADS7884 is a 10-bit, 3-MSPS analog-to-digital converter (ADC), and the ADS7885 is a 8-bit, 3-MSPS ADC. The devices include a capacitor based SAR A/D converter with inherent sample and hold. The serial interface in each device is controlled by the  $\overline{CS}$  and SCLK signals for glueless connections with microprocessors and DSPs. The input signal is sampled with the falling edge of  $\overline{CS}$ , and SCLK is used for conversion and serial data output.

The devices operate from a wide supply range from 2.7 V to 5.5 V. The low power consumption of the devices make them suitable for battery-powered applications. The devices also include a power saving powerdown feature for when the devices are operated at lower conversion speeds.

The high level of the digital input to the device is not limited to device  $V_{DD}$ . This means the digital input can go as high as 5.5 V when device supply is 2.7 V. This feature is useful when digital signals are coming from other circuit with different supply levels. Also this relaxes restriction on power up sequencing.

The ADS7884 and ADS7885 are available in a 6-pin SOT23 package and are specified for operation from –40°C to 125°C.

#### Micro-Power Miniature SAR Converter Family

BIT	< 300 KSPS	300 KSPS – 1.25 MSPS	3 MSPS
12-Bit	ADS7866 (1.2 $V_{DD}$ to 3.6 $V_{DD}$ )	ADS7886 (2.35 $V_{DD}$ to 5.25 $V_{DD}$ )	—
10-Bit	ADS7867 (1.2 $V_{DD}$ to 3.6 $V_{DD}$ )	ADS7887 (2.35 $V_{DD}$ to 5.25 $V_{DD}$ )	ADS7884 (2.7 $V_{DD}$ to 5.5 $V_{DD}$ )
8-Bit	ADS7868 (1.2 $V_{DD}$ to 3.6 $V_{DD}$ )	ADS7888 (2.35 $V_{DD}$ to 5.25 $V_{DD}$ )	ADS7885 (2.7 $V_{DD}$ to 5.5 $V_{DD}$ )



Please be aware that an important notice concerning availability, standard warranty, and use in critical applications of Texas Instruments semiconductor products and disclaimers thereto appears at the end of this data sheet.



These devices have limited built-in ESD protection. The leads should be shorted together or the device placed in conductive foam during storage or handling to prevent electrostatic damage to the MOS gates.

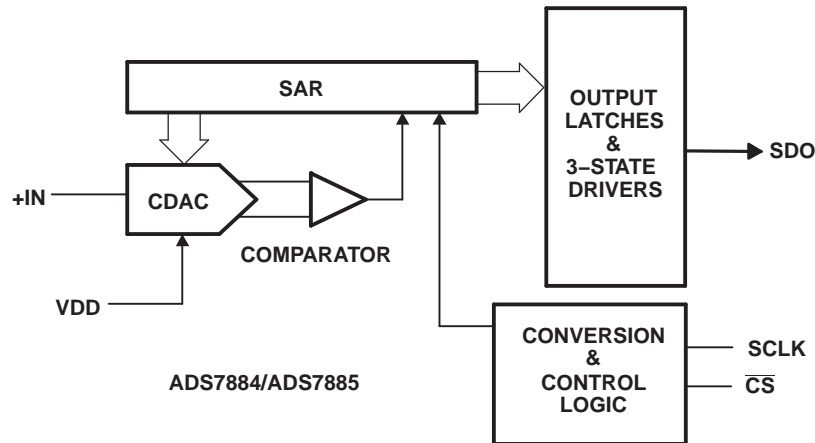

### PACKAGE/ORDERING INFORMATION<sup>(1)</sup>

DEVICE	MAXIMUM INTEGRAL LINEARITY (LSB)	MAXIMUM DIFFERENTIAL LINEARITY (LSB)	NO MISSING CODES AT RESOLUTION (BIT)	PACKAGE TYPE	PACKAGE DESIGNATOR	TEMPERATURE RANGE	PACKAGE MARKING	ORDERING INFORMATION	TRANSPORT MEDIA QUANTITY
ADS7884	±0.8	±0.8	10	6-Pin SOT23	DBV	–40°C to 125°C	7884	ADS7884SDBVT	Tape and reel 250
							7884	ADS7884SDBVR	Tape and reel 3000
ADS7885	±0.4	±0.4	8	6-Pin SOT23	DBV	–40°C to 125°C	7885	ADS7885SDBVT	Tape and reel 250
							7885	ADS7885SDBVR	Tape and reel 3000

(1) For most current package and ordering information, see the Package Option Addendum at the end of this document, or see the TI website at [www.ti.com](http://www.ti.com).

### ABSOLUTE MAXIMUM RATINGS<sup>(1)</sup>

		UNIT
+IN to AGND		–0.3 V to +V <sub>DD</sub> +0.3 V
+V <sub>DD</sub> to AGND		–0.3 V to 7.0 V
Digital input voltage to GND		–0.3V to (7.0 V)
Digital output to GND		–0.3 V to (+V <sub>DD</sub> + 0.3 V)
Operating temperature range		–40°C to 125°C
Storage temperature range		–65°C to 150°C
Junction temperature (T <sub>J</sub> Max)		150°C
Power dissipation, SOT23 package		(T <sub>J</sub> Max–T <sub>A</sub> )/θ <sub>JA</sub>
Thermal impedance, θ <sub>JA</sub>	SOT23	295.2°C/W
Lead temperature, soldering	Vapor phase (60 sec)	215°C
	Infrared (15 sec)	220°C

(1) Stresses above those listed under *absolute maximum ratings* may cause permanent damage to the device. Exposure to absolute maximum conditions for extended periods may affect device reliability.

## ADS7884 SPECIFICATIONS

+V<sub>DD</sub> = 2.7 V to 5.5 V, T<sub>A</sub> = –40°C to 125°C, f<sub>sample</sub> = 2.5 MSPS for V<sub>DD</sub> = 2.7 V to 3.6 V, f<sub>sample</sub> = 3 MSPS for V<sub>DD</sub> = 3.6 V to 5.5 V

PARAMETER		TEST CONDITIONS	MIN	TYP	MAX	UNIT
<b>ANALOG INPUT</b>						
Full-scale input voltage span <sup>(1)</sup>			0		V <sub>DD</sub>	V
Absolute input voltage range		+IN	–0.20		V <sub>DD</sub> +0.20	V
C <sub>i</sub>	Input capacitance <sup>(2)</sup>			27		pF
I <sub>Ilkg</sub>	Input leakage current	T <sub>A</sub> = 125°C		40		nA
<b>SYSTEM PERFORMANCE</b>						
Resolution				10		Bits
No missing codes			10			Bits
INL	Integral nonlinearity		–0.8	±0.3	0.8	LSB <sup>(3)</sup>
DNL	Differential nonlinearity		–0.8	±0.3	0.8	LSB
E <sub>O</sub>	Offset error <sup>(4)(5)(6)</sup>		–1	±0.2	1	LSB
E <sub>G</sub>	Gain error <sup>(5)</sup>		–1	±0.2	1	LSB
<b>SAMPLING DYNAMICS</b>						
Conversion time		48-MHz SCLK, V <sub>DD</sub> = 5 V	224	240		ns
Acquisition time				93.3		ns
Maximum throughput rate		48-MHz SCLK, V <sub>DD</sub> = 5 V			3	MHz
Aperture delay				10		ns
<b>DYNAMIC CHARACTERISTICS</b>						
THD	Total harmonic distortion <sup>(7)</sup>	100 kHz		–81		dB
SINAD	Signal-to-noise and distortion	100 kHz	60	61.7		dB
SFDR	Spurious free dynamic range	100 kHz		81		dB
Full power bandwidth		At –3 dB	30			MHz
<b>DIGITAL INPUT/OUTPUT</b>						
Logic family — CMOS						
V <sub>IH</sub>	High-level input voltage	V <sub>DD</sub> = 2.7 V to 3.6 V	1.5		5.5	V
		V <sub>DD</sub> = 3.6 V to 5.5 V	2.2		5.5	
V <sub>IL</sub>	Low-level input voltage	V <sub>DD</sub> = 5 V			0.8	V
		V <sub>DD</sub> = 3 V			0.4	
V <sub>OH</sub>	High-level output voltage	At I <sub>source</sub> = 200 μA	V <sub>DD</sub> –0.2			V
V <sub>OL</sub>	Low-level output voltage	At I <sub>sink</sub> = 200 μA			0.4	
<b>POWER SUPPLY REQUIREMENTS</b>						
+V <sub>DD</sub>	Supply voltage		2.7	3.3	5.5	V
	Supply current (normal mode)	At V <sub>DD</sub> = 3.0 V, 2.5-MSPS throughput		2.25	3	mA
		At V <sub>DD</sub> = 3.0 V, static state		1.8		
		At V <sub>DD</sub> = 5.0 V, 3-MSPS throughput		3	4	
		At V <sub>DD</sub> = 5.0 V, static state		2		
	Power down state supply current	SCLK off			1	μA
		SCLK on (48 MHz)		90	200	
	Power dissipation	V <sub>DD</sub> = 5 V, 3 MSPS		15	20	mW
		V <sub>DD</sub> = 3 V, 2.5 MSPS		6.8		

- (1) Ideal input span; does not include gain or offset error.
- (2) Refer to [Figure 43](#) for details on sampling circuit
- (3) LSB means least significant bit
- (4) Measured relative to an ideal full-scale input
- (5) Offset error and gain error ensured by characterization.
- (6) First transition of 000H to 001H at (V<sub>ref</sub>/2<sup>10</sup>)
- (7) Calculated on the first nine harmonics of the input frequency

**ADS7884 SPECIFICATIONS (continued)**

+V<sub>DD</sub> = 2.7 V to 5.5 V, T<sub>A</sub> = -40°C to 125°C, f<sub>sample</sub> = 2.5 MSPS for V<sub>DD</sub> = 2.7 V to 3.6 V, f<sub>sample</sub> = 3 MSPS for V<sub>DD</sub> = 3.6 V to 5.5 V

PARAMETER	TEST CONDITIONS	MIN	TYP	MAX	UNIT
Power dissipation in static state	V <sub>DD</sub> = 5 V		10		mW
	V <sub>DD</sub> = 3 V		5.4		
Powerdown time				0.1	μs
Powerup time				0.8	μs
<b>TEMPERATURE RANGE</b>					
Specified performance		-40		125	°C

## ADS7885 SPECIFICATIONS

+V<sub>DD</sub> = 2.7 V to 5.5 V, T<sub>A</sub> = –40°C to 125°C, f<sub>sample</sub> = 2.5 MSPS for V<sub>DD</sub> = 2.7 V to 3.6 V, f<sub>sample</sub> = 3 MSPS for V<sub>DD</sub> = 3.6 V to 5.5 V

PARAMETER		TEST CONDITIONS	MIN	TYP	MAX	UNIT
<b>ANALOG INPUT</b>						
Full-scale input voltage span <sup>(1)</sup>			0		V <sub>DD</sub>	V
Absolute input voltage range		+IN	–0.20		V <sub>DD</sub> +0.20	V
C <sub>i</sub>	Input capacitance <sup>(2)</sup>			27		pF
I <sub>ilkq</sub>	Input leakage current	T <sub>A</sub> = 125°C		40		nA
<b>SYSTEM PERFORMANCE</b>						
Resolution				8		Bits
No missing codes			8			Bits
INL	Integral nonlinearity		–0.4	±0.15	0.4	LSB <sup>(3)</sup>
DNL	Differential nonlinearity		–0.4	±0.1	0.4	LSB
E <sub>O</sub>	Offset error <sup>(4)(5)(6)</sup>		–0.4	±0.1	0.4	LSB
E <sub>G</sub>	Gain error <sup>(5)</sup>		–0.5	±0.1	0.5	LSB
<b>SAMPLING DYNAMICS</b>						
Conversion time		48-MHz SCLK, V <sub>DD</sub> = 5 V	182	198		ns
Acquisition time		3 MSPS mode		135		ns
Maximum throughput rate		48-MHz SCLK, V <sub>DD</sub> = 5 V			3	MHz
Aperture delay				10		ns
<b>DYNAMIC CHARACTERISTICS</b>						
THD	Total harmonic distortion <sup>(7)</sup>	100 kHz		–68		dB
SINAD	Signal-to-noise and distortion	100 kHz	49	49.8		dB
SFDR	Spurious free dynamic range	100 kHz		74		dB
Full power bandwidth		At –3 dB	30			MHz
<b>DIGITAL INPUT/OUTPUT</b>						
Logic family — CMOS						
V <sub>IH</sub>	High-level input voltage	V <sub>DD</sub> = 2.7 V to 3.6 V	1.5		5.5	V
		V <sub>DD</sub> = 3.6 V to 5.5 V	2.2		5.5	
V <sub>IL</sub>	Low-level input voltage	V <sub>DD</sub> = 5 V			0.8	V
		V <sub>DD</sub> = 3 V			0.4	
V <sub>OH</sub>	High-level output voltage	At I <sub>source</sub> = 200 μA	V <sub>DD</sub> –0.2			V
V <sub>OL</sub>	Low-level output voltage	At I <sub>sink</sub> = 200 μA			0.4	
<b>POWER SUPPLY REQUIREMENTS</b>						
+V <sub>DD</sub>	Supply voltage		2.7	3.3	5.5	V
	Supply current (normal mode)	At V <sub>DD</sub> = 3.0 V, 2.5-MSPS throughput		2.25	3	mA
		At V <sub>DD</sub> = 3.0 V, static state		1.8		
		At V <sub>DD</sub> = 5.0 V, 3-MSPS throughput		3	4	
		At V <sub>DD</sub> = 5.0 V, static state		2		
	Power down state supply current	SCLK off			1	μA
		SCLK on (48 MHz)		90	200	
	Power dissipation	V <sub>DD</sub> = 5 V, 3 MSPS		15	20	mW
		V <sub>DD</sub> = 3 V, 2.5 MSPS		6.8		

- (1) Ideal input span; does not include gain or offset error.
- (2) Refer to [Figure 43](#) for details on sampling circuit
- (3) LSB means least significant bit
- (4) Measured relative to an ideal full-scale input
- (5) Offset error and gain error ensured by characterization.
- (6) First transition of 000H to 001H at (V<sub>ref</sub>/2<sup>8</sup>)
- (7) Calculated on the first nine harmonics of the input frequency

### ADS7885 SPECIFICATIONS (continued)

+ $V_{DD} = 2.7\text{ V to }5.5\text{ V}$ ,  $T_A = -40^\circ\text{C to }125^\circ\text{C}$ ,  $f_{\text{sample}} = 2.5\text{ MSPS}$  for  $V_{DD} = 2.7\text{ V to }3.6\text{ V}$ ,  $f_{\text{sample}} = 3\text{ MSPS}$  for  $V_{DD} = 3.6\text{ V to }5.5\text{ V}$

PARAMETER	TEST CONDITIONS	MIN	TYP	MAX	UNIT
Power dissipation in static state	$V_{DD} = 5\text{ V}$		10		mW
	$V_{DD} = 3\text{ V}$		5.4		
Powerdown time				0.1	$\mu\text{s}$
Powerup time				0.8	$\mu\text{s}$
<b>TEMPERATURE RANGE</b>					
Specified performance		-40		125	$^\circ\text{C}$

### TIMING REQUIREMENTS (see Figure 1)

All specifications typical at  $T_A = -40^\circ\text{C to }125^\circ\text{C}$ ,  $V_{DD} = 2.7\text{ V to }5.5\text{ V}$ , unless otherwise specified.

PARAMETER	TEST CONDITIONS <sup>(1)</sup>	MIN	TYP	MAX	UNIT
$t_{\text{conv}}$ Conversion time	ADS7884	$V_{DD} = 3\text{ V}$		$11.5 \times t_{\text{SCLK}}$	ns
		$V_{DD} = 5\text{ V}$		$11.5 \times t_{\text{SCLK}}$	
	ADS7885	$V_{DD} = 3\text{ V}$		$9.5 \times t_{\text{SCLK}}$	
		$V_{DD} = 5\text{ V}$		$9.5 \times t_{\text{SCLK}}$	
$t_{\text{acq}}$ Acquisition time	$V_{DD} = 3\text{ V}$	62.5			ns
	$V_{DD} = 5\text{ V}$	52			
$t_q$ Minimum quiet time needed from bus 3-state to start of next conversion	$V_{DD} = 3\text{ V}$	10			ns
	$V_{DD} = 5\text{ V}$	10			
$t_{d1}$ Delay time, $\overline{\text{CS}}$ low to first data (0) out	$V_{DD} = 3\text{ V}$		9	15	ns
	$V_{DD} = 5\text{ V}$		8	11	
$t_{\text{su}1}$ Setup time, $\overline{\text{CS}}$ low to SCLK low	$V_{DD} = 3\text{ V}$	7			ns
	$V_{DD} = 5\text{ V}$	5			
$t_{d2}$ Delay time, SCLK falling to SDO	$V_{DD} = 3\text{ V}$		11	20	ns
	$V_{DD} = 5\text{ V}$		9	12	
$t_{h1}$ Hold time, SCLK falling to data valid <sup>(2)</sup>	$V_{DD} < 3\text{ V}$	5.5			ns
	$V_{DD} > 5\text{ V}$	4			
$t_{d3}$ Delay time, 16th SCLK falling edge to SDO 3-state	$V_{DD} = 3\text{ V}$		9	15	ns
	$V_{DD} = 5\text{ V}$		8	11	
$t_{w1}$ Pulse duration, $\overline{\text{CS}}$	$V_{DD} = 3\text{ V}$	10			ns
	$V_{DD} = 5\text{ V}$	10			
$t_{d4}$ Delay time, $\overline{\text{CS}}$ high to SDO 3-state,	$V_{DD} = 3\text{ V}$		9	15	ns
	$V_{DD} = 5\text{ V}$		8	11	
$t_{wH}$ Pulse duration, SCLK high	$V_{DD} = 3\text{ V}$	$0.45 \times t_{\text{SCLK}}$			ns
	$V_{DD} = 5\text{ V}$	$0.45 \times t_{\text{SCLK}}$			
$t_{wL}$ Pulse duration, SCLK low	$V_{DD} = 3\text{ V}$	$0.45 \times t_{\text{SCLK}}$			ns
	$V_{DD} = 5\text{ V}$	$0.45 \times t_{\text{SCLK}}$			
Frequency, SCLK	$V_{DD} = 3\text{ V}$			40	MHz
	$V_{DD} = 5\text{ V}$			48	
$t_{d5}$ Delay time, second falling edge of clock and $\overline{\text{CS}}$ to enter in powerdown (use min spec not to accidentally enter in powerdown) <a href="#">Figure 3</a>	$V_{DD} = 3\text{ V}$	-2		4	ns
	$V_{DD} = 5\text{ V}$	-2		3	

(1) 3-V Specifications apply from 2.7 V to 3.6 V, and 5-V specifications apply from 4.5 V to 5.5 V.

(2) With 10-pf load.

## TIMING REQUIREMENTS (see Figure 1) (continued)

All specifications typical at  $T_A = -40^\circ\text{C}$  to  $125^\circ\text{C}$ ,  $V_{DD} = 2.7\text{ V}$  to  $5.5\text{ V}$ , unless otherwise specified.

PARAMETER	TEST CONDITIONS <sup>(1)</sup>	MIN	TYP	MAX	UNIT
$t_{d6}$ Delay time, $\overline{\text{CS}}$ and 10th falling edge of clock to enter in powerdown (use max spec not to accidentally enter in powerdown) Figure 3	$V_{DD} = 3\text{ V}$	-2		4	ns
	$V_{DD} = 5\text{ V}$	-2		3	

## DEVICE INFORMATION

### SOT23 PACKAGE (TOP VIEW)

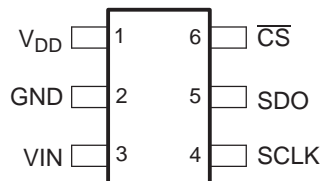

## TERMINAL FUNCTIONS

TERMINAL	I/O	DESCRIPTION
NAME NO.		
$V_{DD}$ 1	–	Power supply input also acts like a reference voltage to ADC.
GND 2	–	Ground for power supply, all analog and digital signals are referred with respect to this pin.
VIN 3	I	Analog signal input
SCLK 4	I	Serial clock
SDO 5	O	Serial data out
$\overline{\text{CS}}$ 6	I	Chip select signal, active low

## ADS7884 NORMAL OPERATION

The cycle begins with the falling edge of  $\overline{\text{CS}}$ . This point is indicated as **a** in Figure 1. With the falling edge of  $\overline{\text{CS}}$ , the input signal is sampled and the conversion process is initiated. The device outputs data while the conversion is in progress. The data word contains 2 leading zeros, followed by 10-bit data in MSB first format and padded by 4 lagging zeros.

The falling edge of  $\overline{\text{CS}}$  clocks out the first zero, and a second zero is clocked out on FIRST falling edge of the clock. Data is in MSB first format with the MSB being clocked out on the 2nd falling edge. Data is padded with four lagging zeros as shown in Figure 1. The conversion ends on the first rising edge of SCLK after the 11th falling edge. At this point the device enters the acquisition phase. This point is indicated by **b** in Figure 1.

Figure 1 shows device data is read in a sixteen clock frame. However,  $\overline{\text{CS}}$  can be asserted (pulled high) any time after 11 clocks have elapsed. SDO goes to 3-state with the  $\overline{\text{CS}}$  high level. The next conversion should not be started (by pulling  $\overline{\text{CS}}$  low) until the end of the quiet sampling time ( $t_q$ ) after SDO goes to 3-state or until the minimum acquisition time ( $t_{acq}$ ) has elapsed. To continue normal operation, it is necessary that  $\overline{\text{CS}}$  is not pulled high until point **b**. Without this, the device does not enter the acquisition phase and no valid data is available in the next cycle. (Also refer to the Powerdown Mode section for more details.)  $\overline{\text{CS}}$  going high any time after the conversion start aborts the ongoing conversion and SDO goes to 3-state.

The high level of the digital input to the device is not limited to device  $V_{DD}$ . This means the digital input can go as high as 5.5 V when the device supply is 2.7 V. This feature is useful when digital signals are coming from another circuit with different supply levels. Also, this relaxes the restriction on powerup sequencing. However, the digital output levels ( $V_{OH}$  and  $V_{OL}$ ) are governed by  $V_{DD}$  as listed in the Specifications table.

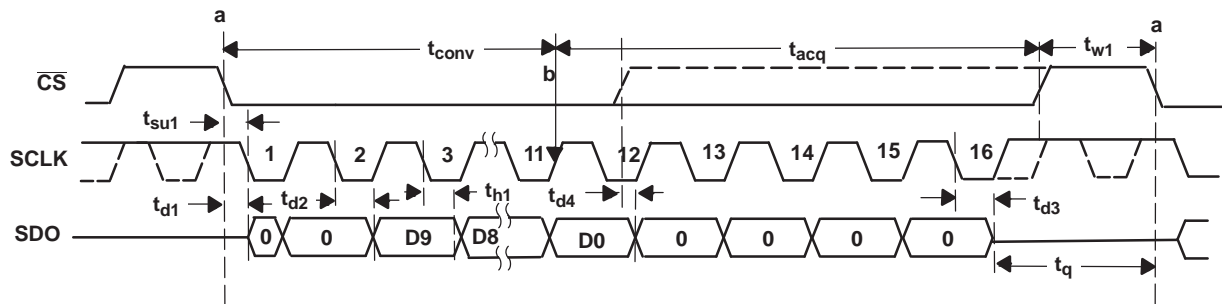

Figure 1. ADS7884 Interface Timing Diagram

### ADS7885 NORMAL OPERATION

The cycle begins with the falling edge of  $\overline{CS}$ . This point is indicated as **a** in Figure 2. With the falling edge of  $\overline{CS}$ , the input signal is sampled and the conversion process is initiated. The device outputs data while the conversion is in progress. The data word contains 2 leading zeros, followed by 8-bit data in MSB first format and padded by 6 lagging zeros.

The falling edge of  $\overline{CS}$  clocks out the first zero, and a second zero is clocked out on FIRST falling edge of the clock. Data is in MSB first format with the MSB being clocked out on the 3rd falling edge. Data is padded with six lagging zeros as shown in Figure 2. On the 16th falling edge of SCLK, SDO goes to the 3-state condition. The conversion ends on the first rising edge of SCLK after the 9th falling edge. At this point the device enters the acquisition phase. This point is indicated by **b** in Figure 2.

Figure 2 shows device data is read in a sixteen clock frame. However,  $\overline{CS}$  can be asserted (pulled high) any time after 9 clocks have elapsed (after the 10th falling edge of SCLK). SDO goes to 3-state with the  $\overline{CS}$  high level. The next conversion should not be started (by pulling  $\overline{CS}$  low) until the end of the quiet sampling time ( $t_q$ ) after SDO goes to 3-state or until the minimum acquisition time ( $t_{acq}$ ) has elapsed. To continue normal operation, it is necessary that  $\overline{CS}$  is not pulled high until point **b**. Without this, the device does not enter the acquisition phase and no valid data is available in the next cycle. (Also refer to the Powerdown Mode section for more details.)  $\overline{CS}$  going high any time after the conversion start aborts the ongoing conversion and SDO goes to 3-state.

The high level of the digital input to the device is not limited to device  $V_{DD}$ . This means the digital input can go as high as 5.5 V when the device supply is 2.7 V. This feature is useful when digital signals are coming from another circuit with different supply levels. Also, this relaxes the restriction on powerup sequencing. However, the digital output levels ( $V_{OH}$  and  $V_{OL}$ ) are governed by  $V_{DD}$  as listed in the Specifications section.

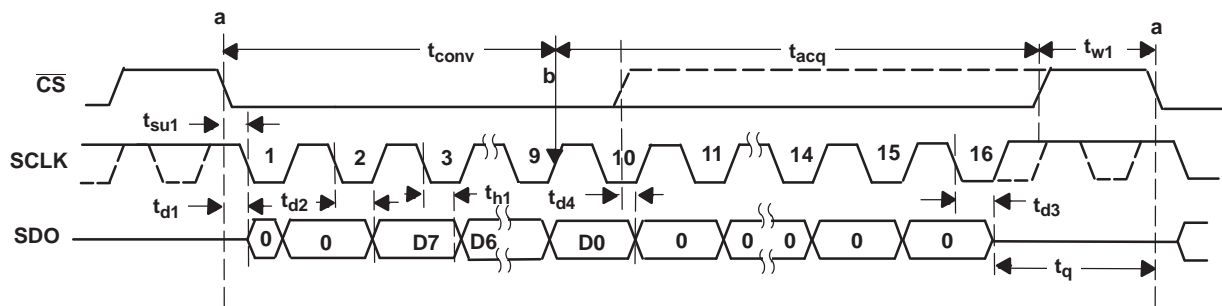
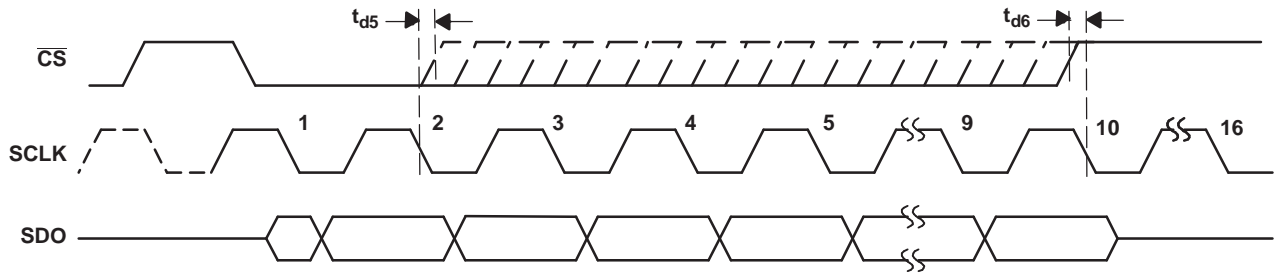

Figure 2. ADS7885 Interface Timing Diagram

### POWER DOWN MODE

The device enters powerdown mode if  $\overline{CS}$  goes high anytime after the 2nd SCLK falling edge to before the 10th SCLK falling edge. Ongoing conversion stops and SDO goes to 3-state under this powerdown condition as shown in Figure 3.





**Figure 3. Entering Power Down Mode**

A dummy cycle with  $\overline{CS}$  low for more than 10 SCLK falling edges brings the device out of powerdown mode. For the device to come to the fully powered up condition it takes 0.8  $\mu\text{s}$ .  $\overline{CS}$  can be pulled high any time after the 10th falling edge as shown in Figure 4. Note that the powerup time of 0.8  $\mu\text{s}$  is more than a single conversion cycle at 3 MSPS speed. This means the device requires three dummy conversion frames at 3 MSPS speed or one elongated dummy conversion frame. The data during dummy conversion frames is invalid.

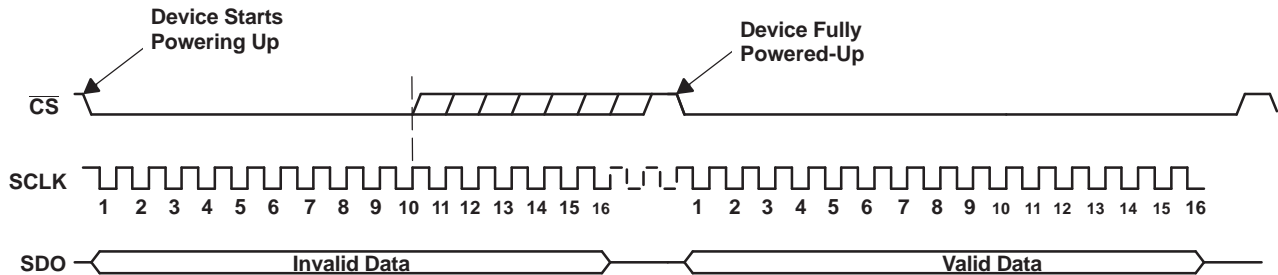

**Figure 4. Exiting Power Down Mode**

TYPICAL CHARACTERISTICS ADS7884

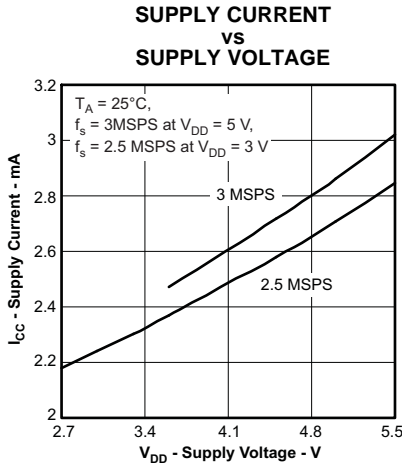

Figure 5.

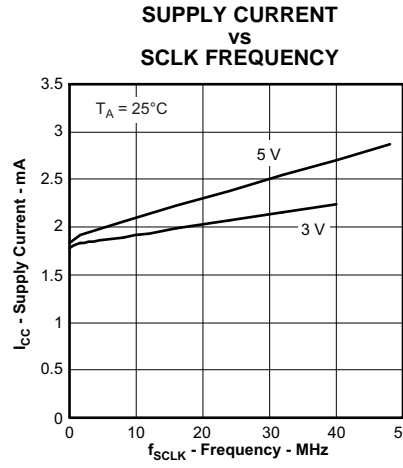

Figure 6.

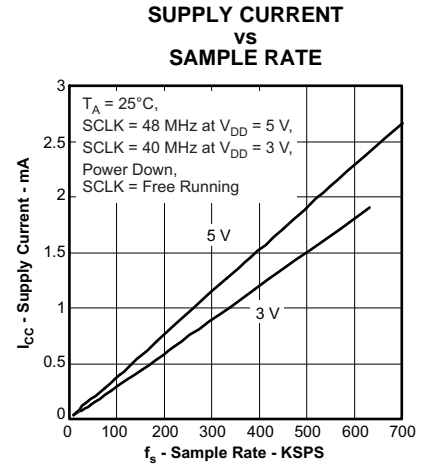

Figure 7.

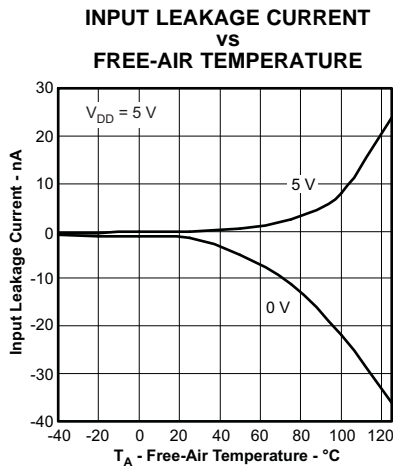

Figure 8.

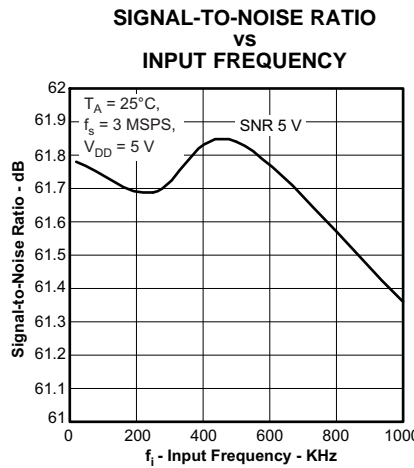

Figure 9.

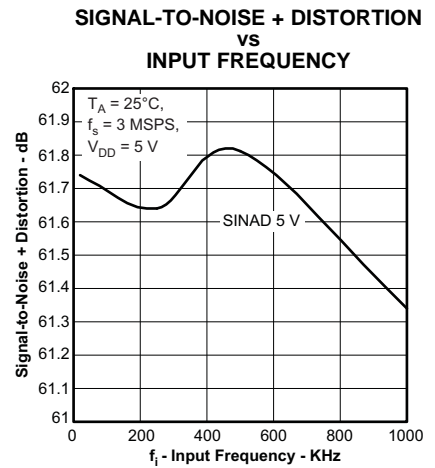

Figure 10.

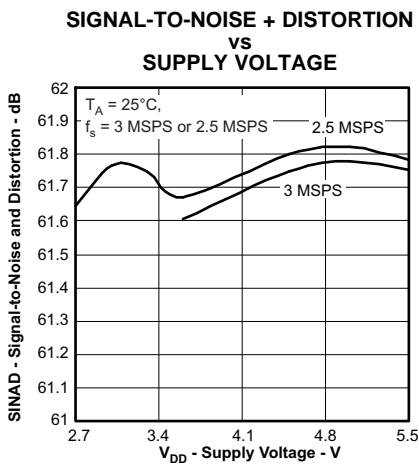

Figure 11.

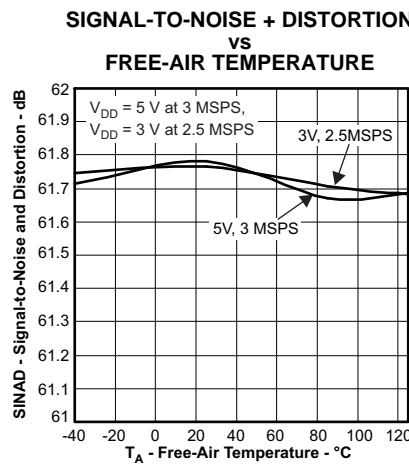

Figure 12.

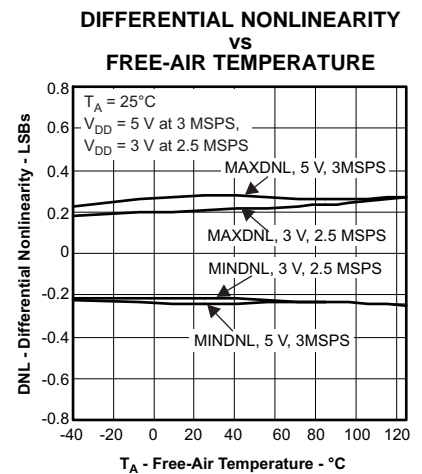

Figure 13.

TYPICAL CHARACTERISTICS ADS7884 (continued)

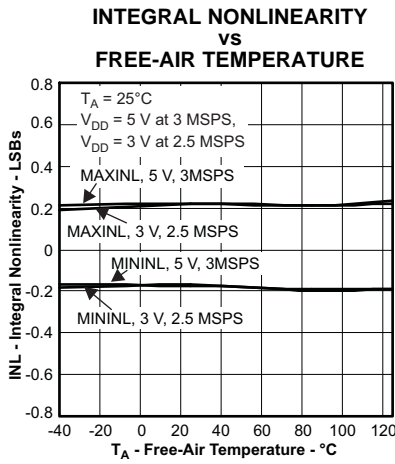

Figure 14.

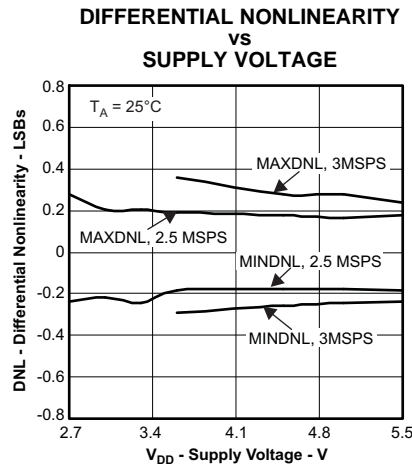

Figure 15.

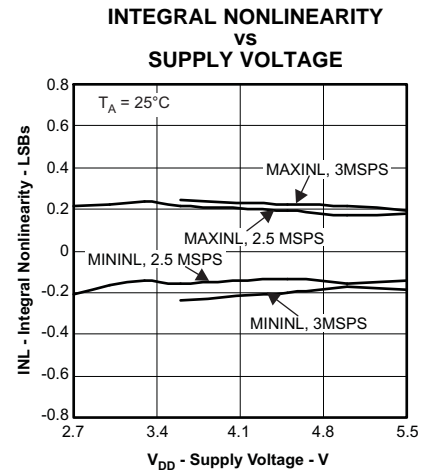

Figure 16.

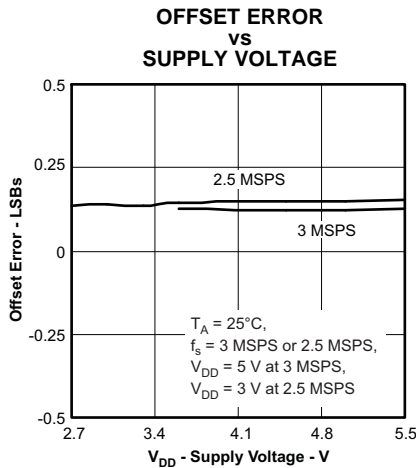

Figure 17.

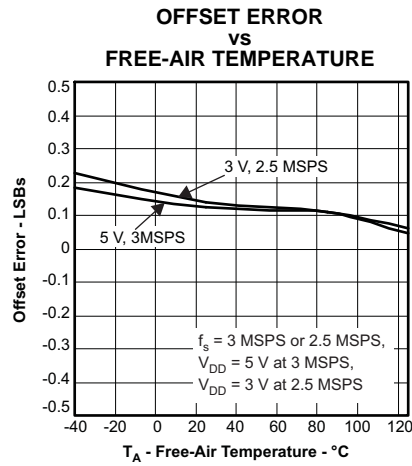

Figure 18.

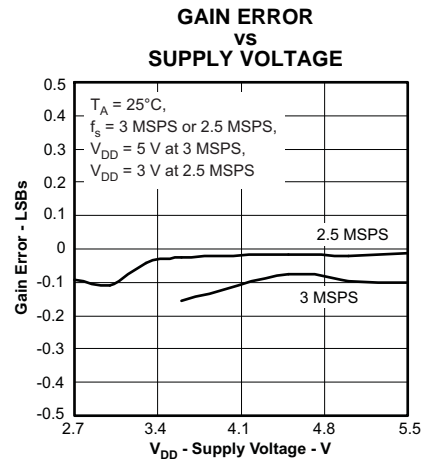

Figure 19.

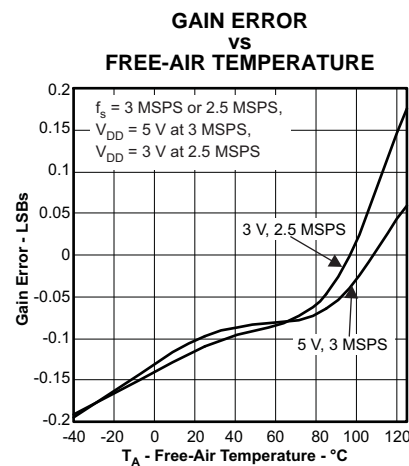

Figure 20.

TYPICAL CHARACTERISTICS ADS7884 (continued)

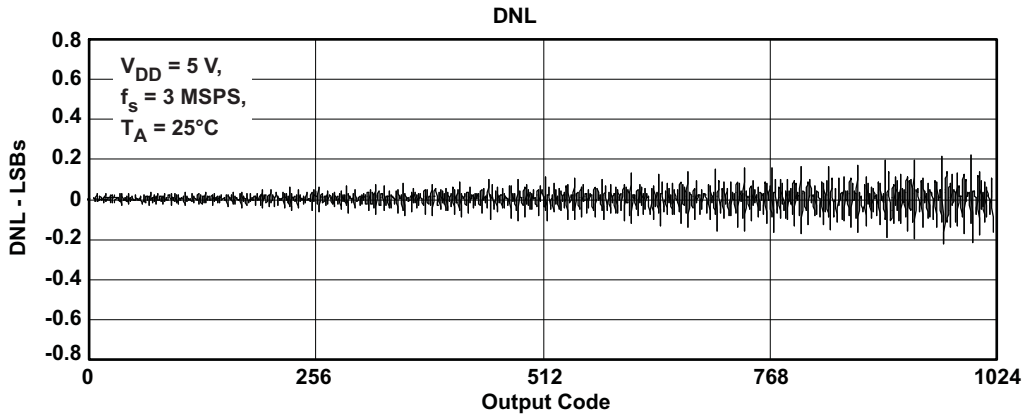

Figure 21.

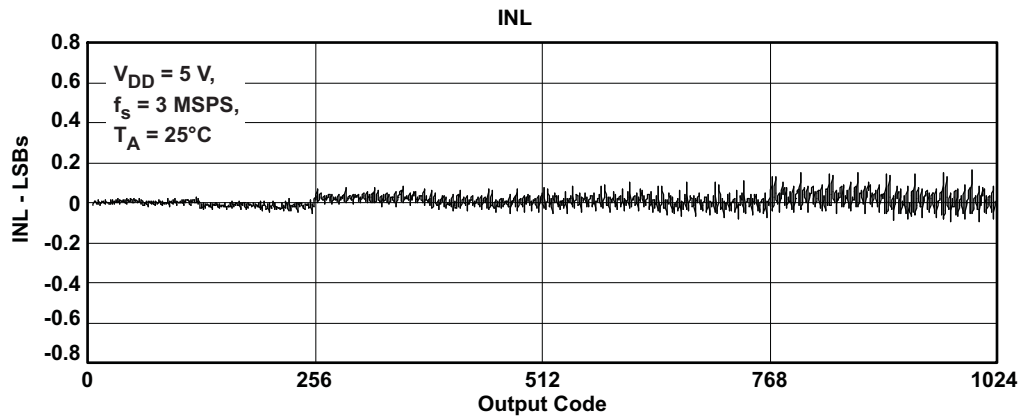

Figure 22.

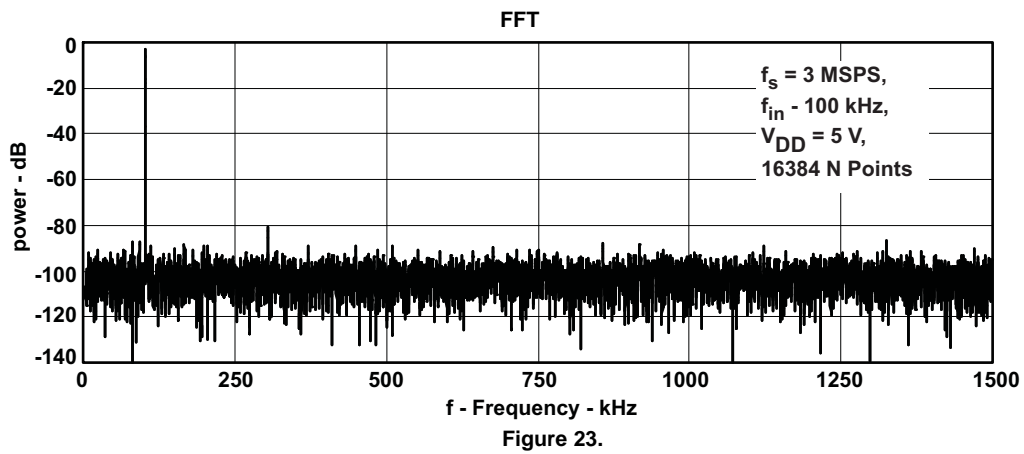

Figure 23.

TYPICAL CHARACTERISTICS ADS7885

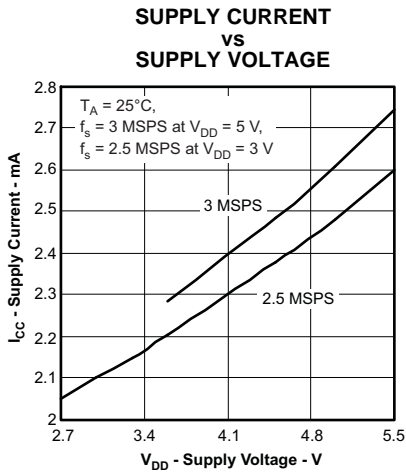

Figure 24.

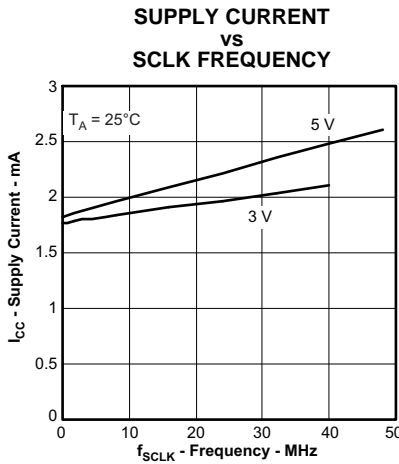

Figure 25.

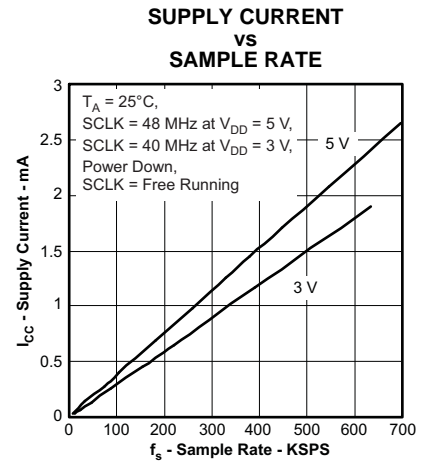

Figure 26.

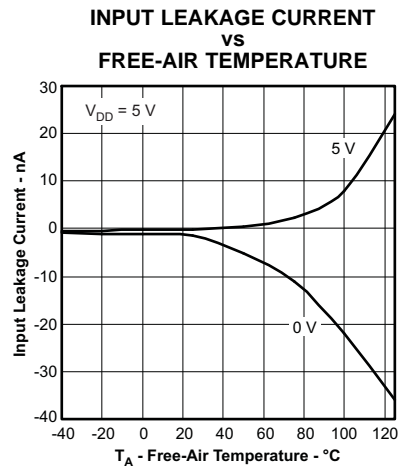

Figure 27.

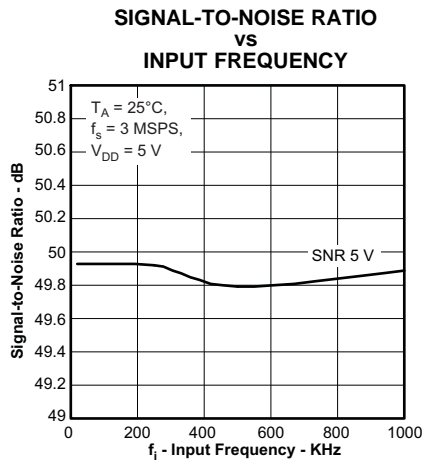

Figure 28.

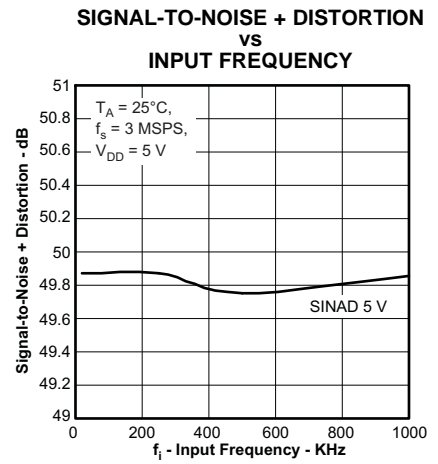

Figure 29.

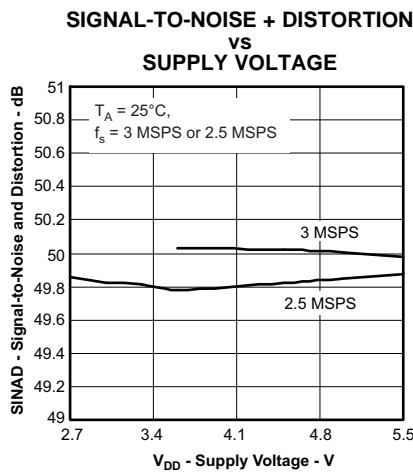

Figure 30.

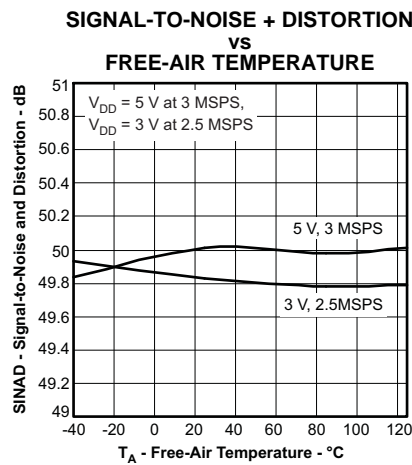

Figure 31.

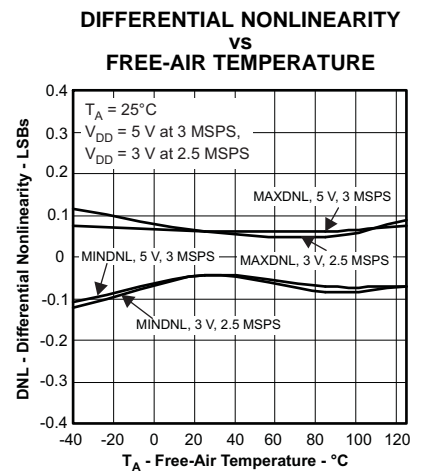

Figure 32.

TYPICAL CHARACTERISTICS ADS7885 (continued)

INTEGRAL NONLINEARITY  
vs  
FREE-AIR TEMPERATURE

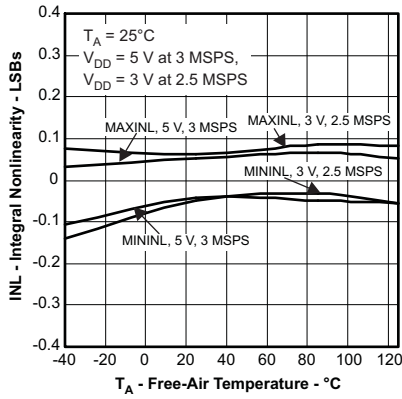

Figure 33.

DIFFERENTIAL NONLINEARITY  
vs  
SUPPLY VOLTAGE

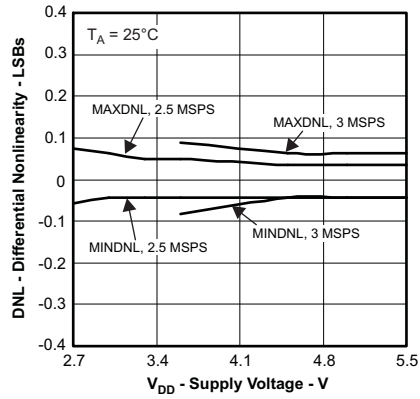

Figure 34.

INTEGRAL NONLINEARITY  
vs  
SUPPLY VOLTAGE

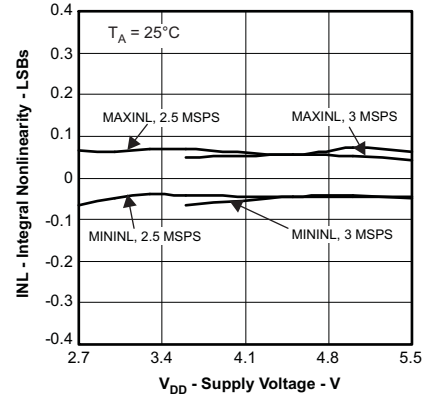

Figure 35.

OFFSET ERROR  
vs  
SUPPLY VOLTAGE

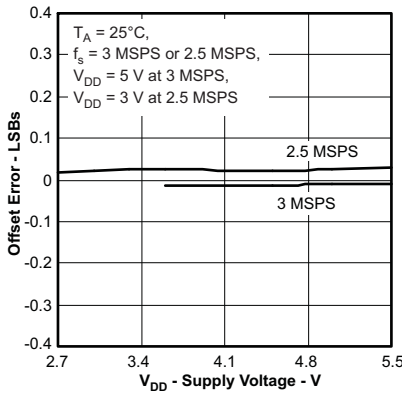

Figure 36.

OFFSET ERROR  
vs  
FREE-AIR TEMPERATURE

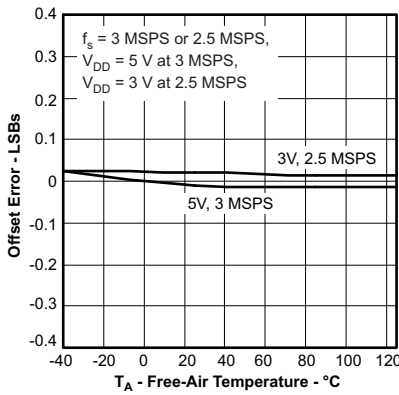

Figure 37.

GAIN ERROR  
vs  
SUPPLY VOLTAGE

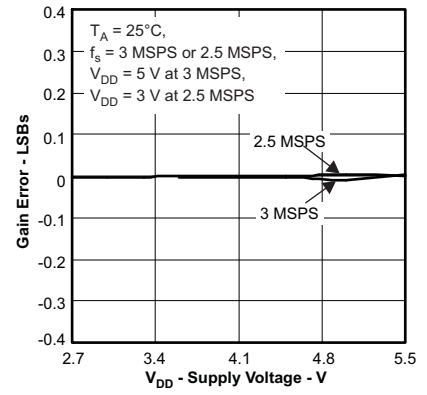

Figure 38.

GAIN ERROR  
vs  
FREE-AIR TEMPERATURE

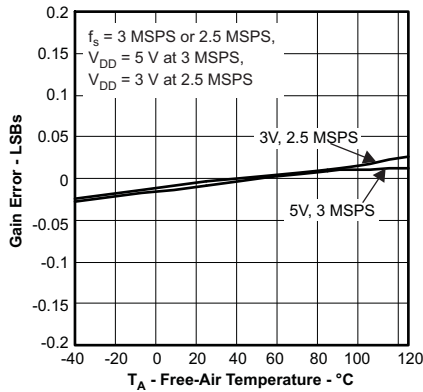

Figure 39.

**TYPICAL CHARACTERISTICS ADS7885 (continued)**

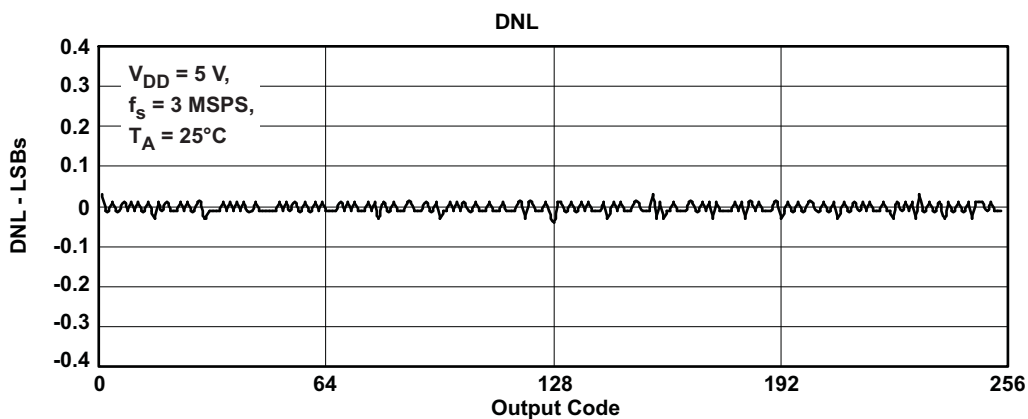

Figure 40.

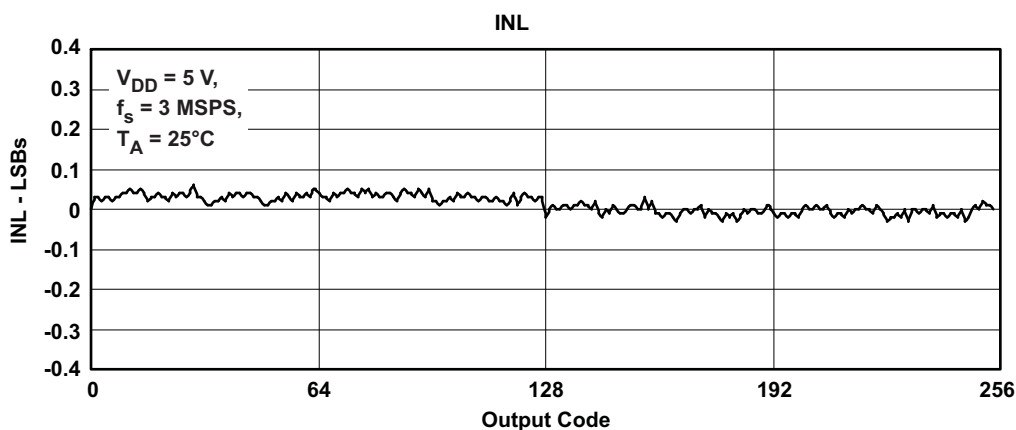

Figure 41.

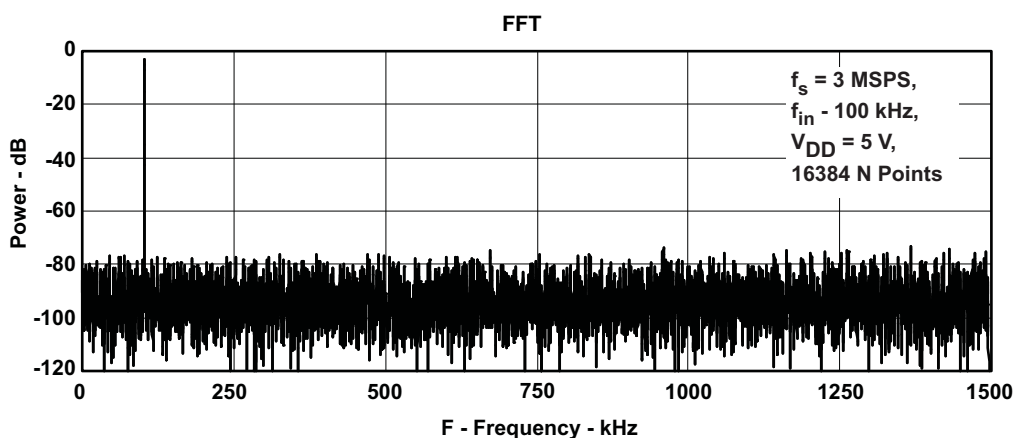

Figure 42.

## APPLICATION INFORMATION

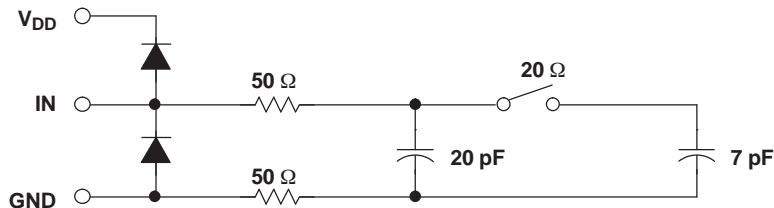

Figure 43. Typical Equivalent Sampling Circuit

### Driving the VIN and V<sub>DD</sub> Pins of the ADS7884 and ADS7885

The VIN input to the ADS7884 and ADS7885 should be driven with a low impedance source. In most cases additional buffers are not required. In cases where the source impedance exceeds 200  $\Omega$ , using a buffer would help achieve the rated performance of the converter. The THS4031 is a good choice for the driver amplifier buffer.

The reference voltage for the ADS7884 and ADS7885 A/D converters are derived from the supply voltage internally. The devices offer limited low-pass filtering functionality on-chip. The supply to these converters should be driven with a low impedance source and should be decoupled to the ground. A 1- $\mu$ F storage capacitor and a 10-nF decoupling capacitor should be placed close to the device. Wide, low impedance traces should be used to connect the capacitor to the pins of the device. The ADS7884 and ADS7885 draw very little current from the supply lines. The supply line can be driven by either:

- Directly from the system supply.
- A reference output from a low drift and low drop out reference voltage generator like REF3030 or REF3130. The ADS7884 and ADS7885 can operate off a wide range of supply voltages. The actual choice of the reference voltage generator would depend upon the system. Figure 45 shows one possible application circuit.
- A low-pass filtered version of the system supply followed by a buffer like the zero-drift OPA735 can also be used in cases where the system power supply is noisy. Care should be taken to ensure that the voltage at the V<sub>DD</sub> input does not exceed 7 V (especially during power up) to avoid damage to the converter. This can be done easily using single supply CMOS amplifiers like the OPA735. Figure 46 shows one possible application circuit.

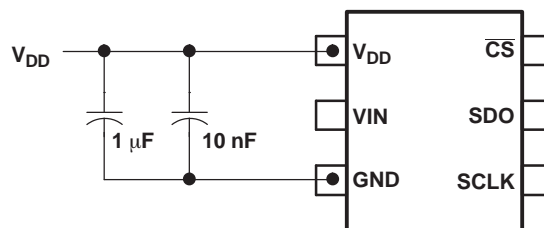

Figure 44. Supply/Reference Decoupling Capacitors

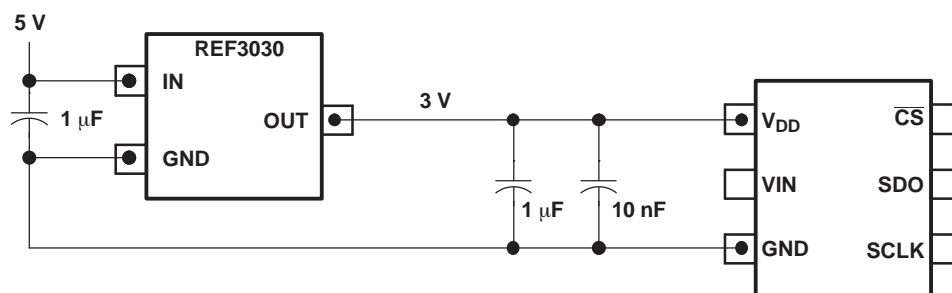
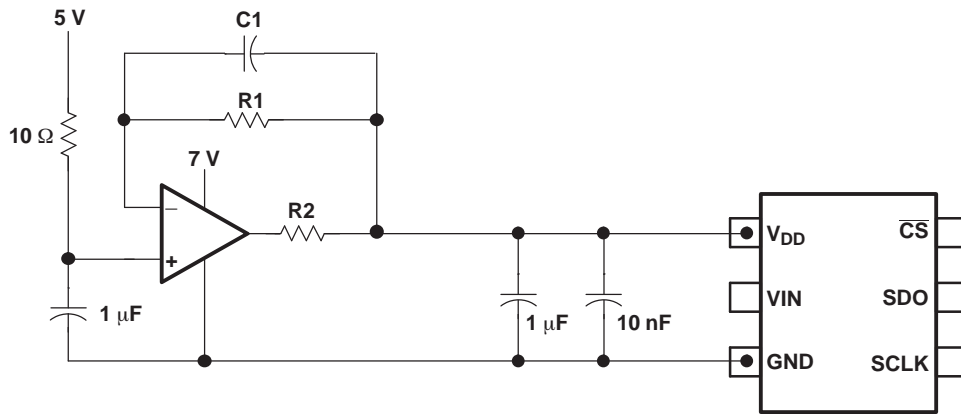

Figure 45. Using the REF3030 Reference





**Figure 46. Buffering with the OPA735**

**PACKAGING INFORMATION**

Orderable Device	Status <sup>(1)</sup>	Package Type	Package Drawing	Pins	Package Qty	Eco Plan <sup>(2)</sup>	Lead/Ball Finish	MSL Peak Temp <sup>(3)</sup>
ADS7884SDBVR	ACTIVE	SOT-23	DBV	6	3000	Pb-Free (RoHS Exempt)	CU NIPDAU	Level-2-260C-1 YEAR
ADS7884SDBVT	ACTIVE	SOT-23	DBV	6	250	Pb-Free (RoHS Exempt)	CU NIPDAU	Level-2-260C-1 YEAR
ADS7885SDBVR	ACTIVE	SOT-23	DBV	6	3000	Pb-Free (RoHS Exempt)	CU NIPDAU	Level-2-260C-1 YEAR
ADS7885SDBVT	ACTIVE	SOT-23	DBV	6	250	Pb-Free (RoHS Exempt)	CU NIPDAU	Level-2-260C-1 YEAR

<sup>(1)</sup> The marketing status values are defined as follows:

**ACTIVE:** Product device recommended for new designs.

**LIFEBUY:** TI has announced that the device will be discontinued, and a lifetime-buy period is in effect.

**NRND:** Not recommended for new designs. Device is in production to support existing customers, but TI does not recommend using this part in a new design.

**PREVIEW:** Device has been announced but is not in production. Samples may or may not be available.

**OBSOLETE:** TI has discontinued the production of the device.

<sup>(2)</sup> Eco Plan - The planned eco-friendly classification: Pb-Free (RoHS), Pb-Free (RoHS Exempt), or Green (RoHS & no Sb/Br) - please check <http://www.ti.com/productcontent> for the latest availability information and additional product content details.

**TBD:** The Pb-Free/Green conversion plan has not been defined.

**Pb-Free (RoHS):** TI's terms "Lead-Free" or "Pb-Free" mean semiconductor products that are compatible with the current RoHS requirements for all 6 substances, including the requirement that lead not exceed 0.1% by weight in homogeneous materials. Where designed to be soldered at high temperatures, TI Pb-Free products are suitable for use in specified lead-free processes.

**Pb-Free (RoHS Exempt):** This component has a RoHS exemption for either 1) lead-based flip-chip solder bumps used between the die and package, or 2) lead-based die adhesive used between the die and leadframe. The component is otherwise considered Pb-Free (RoHS compatible) as defined above.

**Green (RoHS & no Sb/Br):** TI defines "Green" to mean Pb-Free (RoHS compatible), and free of Bromine (Br) and Antimony (Sb) based flame retardants (Br or Sb do not exceed 0.1% by weight in homogeneous material)

<sup>(3)</sup> MSL, Peak Temp. -- The Moisture Sensitivity Level rating according to the JEDEC industry standard classifications, and peak solder temperature.

**Important Information and Disclaimer:**The information provided on this page represents TI's knowledge and belief as of the date that it is provided. TI bases its knowledge and belief on information provided by third parties, and makes no representation or warranty as to the accuracy of such information. Efforts are underway to better integrate information from third parties. TI has taken and continues to take reasonable steps to provide representative and accurate information but may not have conducted destructive testing or chemical analysis on incoming materials and chemicals. TI and TI suppliers consider certain information to be proprietary, and thus CAS numbers and other limited information may not be available for release.

In no event shall TI's liability arising out of such information exceed the total purchase price of the TI part(s) at issue in this document sold by TI to Customer on an annual basis.

**TAPE AND REEL INFORMATION**

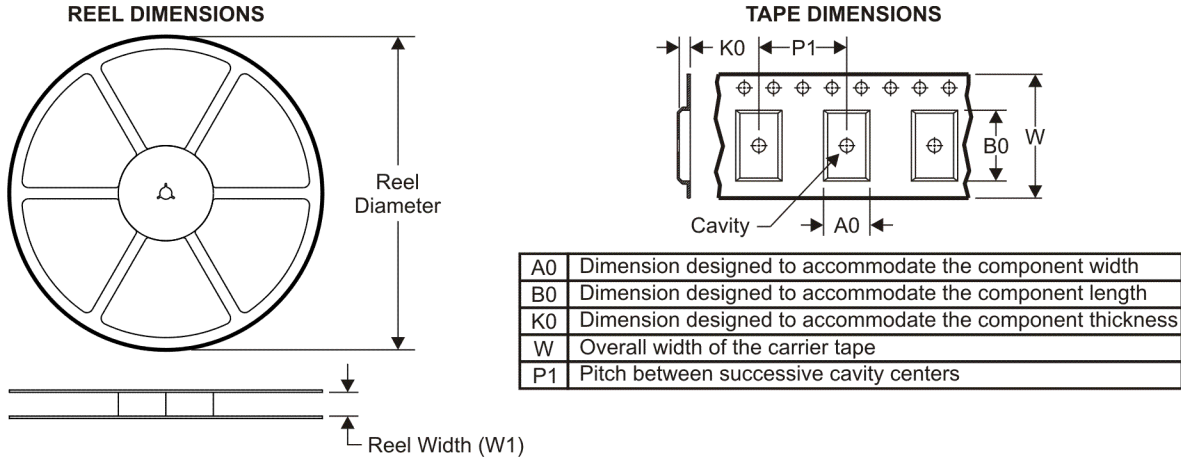

**QUADRANT ASSIGNMENTS FOR PIN 1 ORIENTATION IN TAPE**

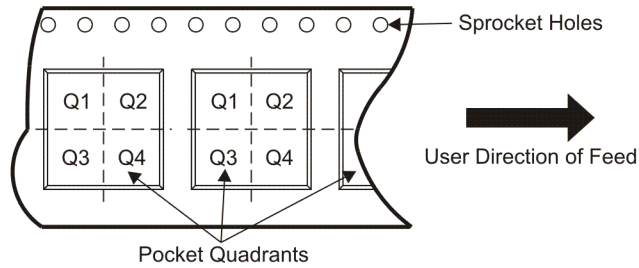

\*All dimensions are nominal

Device	Package Type	Package Drawing	Pins	SPQ	Reel Diameter (mm)	Reel Width W1 (mm)	A0 (mm)	B0 (mm)	K0 (mm)	P1 (mm)	W (mm)	Pin1 Quadrant
ADS7884SDBVR	SOT-23	DBV	6	3000	177.8	9.7	3.2	3.1	1.39	4.0	8.0	Q3
ADS7884SDBVT	SOT-23	DBV	6	250	177.8	9.7	3.2	3.1	1.39	4.0	8.0	Q3
ADS7885SDBVR	SOT-23	DBV	6	3000	177.8	9.7	3.2	3.1	1.39	4.0	8.0	Q3
ADS7885SDBVT	SOT-23	DBV	6	250	177.8	9.7	3.2	3.1	1.39	4.0	8.0	Q3

**TAPE AND REEL BOX DIMENSIONS**

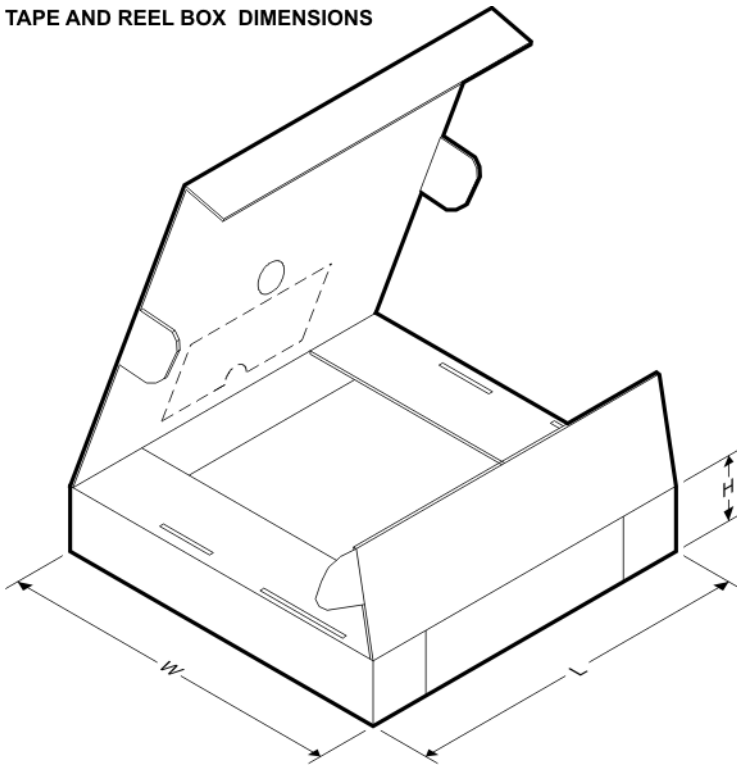

\*All dimensions are nominal

Device	Package Type	Package Drawing	Pins	SPQ	Length (mm)	Width (mm)	Height (mm)
ADS7884SDBVR	SOT-23	DBV	6	3000	184.0	184.0	50.0
ADS7884SDBVT	SOT-23	DBV	6	250	184.0	184.0	50.0
ADS7885SDBVR	SOT-23	DBV	6	3000	184.0	184.0	50.0
ADS7885SDBVT	SOT-23	DBV	6	250	184.0	184.0	50.0

DBV (R-PDSO-G6)

PLASTIC SMALL-OUTLINE PACKAGE

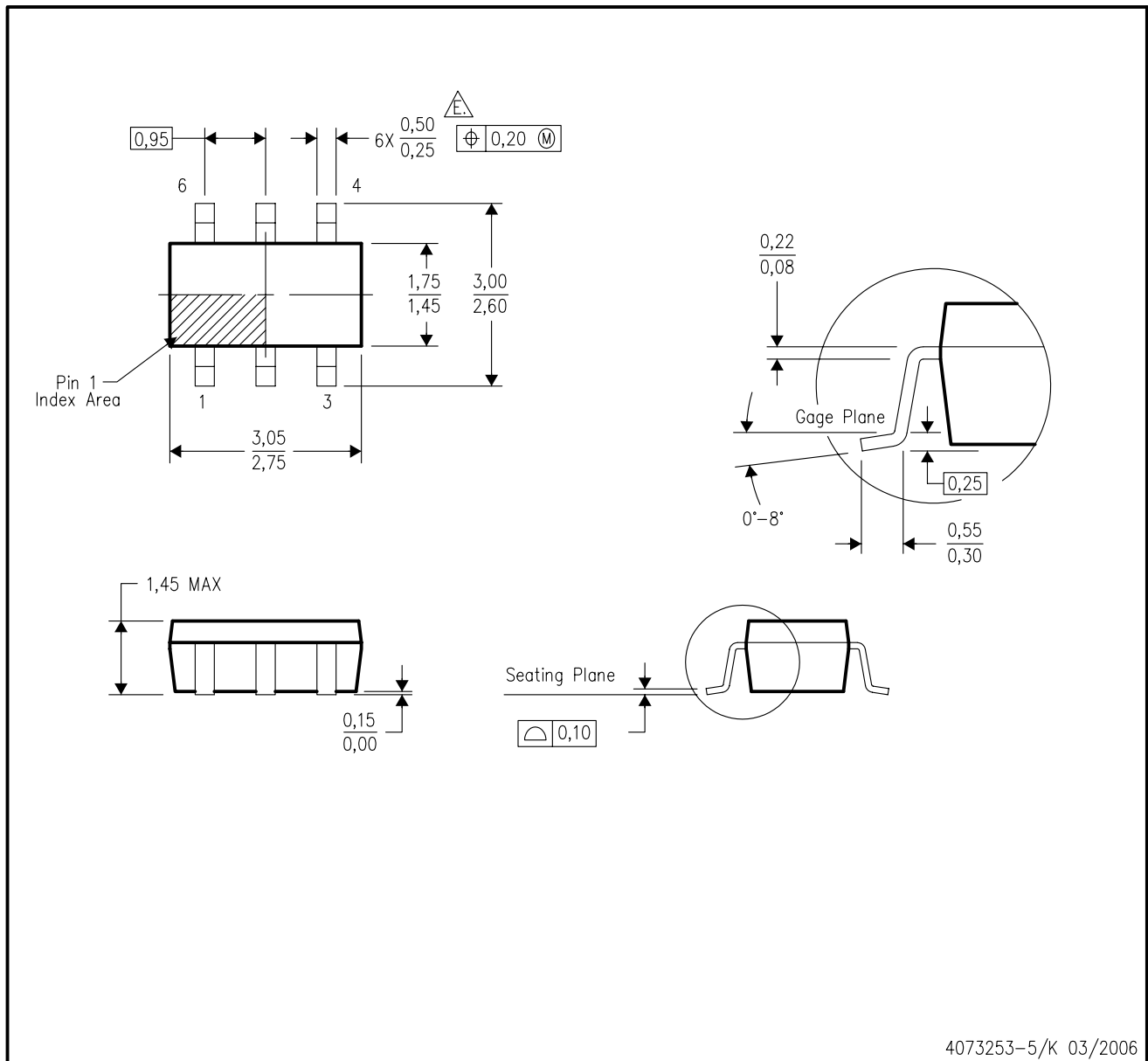

- NOTES:
- A. All linear dimensions are in millimeters.
  - B. This drawing is subject to change without notice.
  - C. Body dimensions do not include mold flash or protrusion. Mold flash and protrusion shall not exceed 0.15 per side.
  - D. Leads 1,2,3 may be wider than leads 4,5,6 for package orientation.
- $\triangle$  Falls within JEDEC MO-178 Variation AB, except minimum lead width.

## IMPORTANT NOTICE

Texas Instruments Incorporated and its subsidiaries (TI) reserve the right to make corrections, modifications, enhancements, improvements, and other changes to its products and services at any time and to discontinue any product or service without notice. Customers should obtain the latest relevant information before placing orders and should verify that such information is current and complete. All products are sold subject to TI's terms and conditions of sale supplied at the time of order acknowledgment.

TI warrants performance of its hardware products to the specifications applicable at the time of sale in accordance with TI's standard warranty. Testing and other quality control techniques are used to the extent TI deems necessary to support this warranty. Except where mandated by government requirements, testing of all parameters of each product is not necessarily performed.

TI assumes no liability for applications assistance or customer product design. Customers are responsible for their products and applications using TI components. To minimize the risks associated with customer products and applications, customers should provide adequate design and operating safeguards.

TI does not warrant or represent that any license, either express or implied, is granted under any TI patent right, copyright, mask work right, or other TI intellectual property right relating to any combination, machine, or process in which TI products or services are used. Information published by TI regarding third-party products or services does not constitute a license from TI to use such products or services or a warranty or endorsement thereof. Use of such information may require a license from a third party under the patents or other intellectual property of the third party, or a license from TI under the patents or other intellectual property of TI.

Reproduction of TI information in TI data books or data sheets is permissible only if reproduction is without alteration and is accompanied by all associated warranties, conditions, limitations, and notices. Reproduction of this information with alteration is an unfair and deceptive business practice. TI is not responsible or liable for such altered documentation. Information of third parties may be subject to additional restrictions.

Resale of TI products or services with statements different from or beyond the parameters stated by TI for that product or service voids all express and any implied warranties for the associated TI product or service and is an unfair and deceptive business practice. TI is not responsible or liable for any such statements.

TI products are not authorized for use in safety-critical applications (such as life support) where a failure of the TI product would reasonably be expected to cause severe personal injury or death, unless officers of the parties have executed an agreement specifically governing such use. Buyers represent that they have all necessary expertise in the safety and regulatory ramifications of their applications, and acknowledge and agree that they are solely responsible for all legal, regulatory and safety-related requirements concerning their products and any use of TI products in such safety-critical applications, notwithstanding any applications-related information or support that may be provided by TI. Further, Buyers must fully indemnify TI and its representatives against any damages arising out of the use of TI products in such safety-critical applications.

TI products are neither designed nor intended for use in military/aerospace applications or environments unless the TI products are specifically designated by TI as military-grade or "enhanced plastic." Only products designated by TI as military-grade meet military specifications. Buyers acknowledge and agree that any such use of TI products which TI has not designated as military-grade is solely at the Buyer's risk, and that they are solely responsible for compliance with all legal and regulatory requirements in connection with such use.

TI products are neither designed nor intended for use in automotive applications or environments unless the specific TI products are designated by TI as compliant with ISO/TS 16949 requirements. Buyers acknowledge and agree that, if they use any non-designated products in automotive applications, TI will not be responsible for any failure to meet such requirements.

Following are URLs where you can obtain information on other Texas Instruments products and application solutions:

### Products

Amplifiers	<a href="http://amplifier.ti.com">amplifier.ti.com</a>
Data Converters	<a href="http://dataconverter.ti.com">dataconverter.ti.com</a>
DSP	<a href="http://dsp.ti.com">dsp.ti.com</a>
Clocks and Timers	<a href="http://www.ti.com/clocks">www.ti.com/clocks</a>
Interface	<a href="http://interface.ti.com">interface.ti.com</a>
Logic	<a href="http://logic.ti.com">logic.ti.com</a>
Power Mgmt	<a href="http://power.ti.com">power.ti.com</a>
Microcontrollers	<a href="http://microcontroller.ti.com">microcontroller.ti.com</a>
RFID	<a href="http://www.ti-rfid.com">www.ti-rfid.com</a>
RF/IF and ZigBee® Solutions	<a href="http://www.ti.com/lprf">www.ti.com/lprf</a>

### Applications

Audio	<a href="http://www.ti.com/audio">www.ti.com/audio</a>
Automotive	<a href="http://www.ti.com/automotive">www.ti.com/automotive</a>
Broadband	<a href="http://www.ti.com/broadband">www.ti.com/broadband</a>
Digital Control	<a href="http://www.ti.com/digitalcontrol">www.ti.com/digitalcontrol</a>
Medical	<a href="http://www.ti.com/medical">www.ti.com/medical</a>
Military	<a href="http://www.ti.com/military">www.ti.com/military</a>
Optical Networking	<a href="http://www.ti.com/opticalnetwork">www.ti.com/opticalnetwork</a>
Security	<a href="http://www.ti.com/security">www.ti.com/security</a>
Telephony	<a href="http://www.ti.com/telephony">www.ti.com/telephony</a>
Video & Imaging	<a href="http://www.ti.com/video">www.ti.com/video</a>
Wireless	<a href="http://www.ti.com/wireless">www.ti.com/wireless</a>

Mailing Address: Texas Instruments, Post Office Box 655303, Dallas, Texas 75265  
Copyright © 2008, Texas Instruments Incorporated