

0.5mm pitch, 0.9mm above the board, Flexible Printed Circuit & Flexible Flat Cable ZIF Connectors

FH19C & FH19SC Series

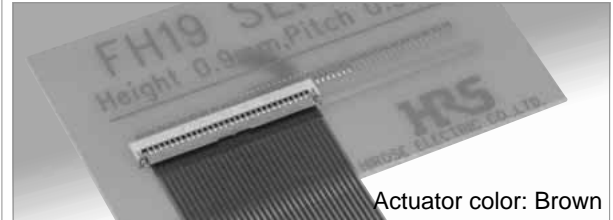

FH19SC – FPC/FFC thickness: $0.3 \pm 0.03\text{mm}$

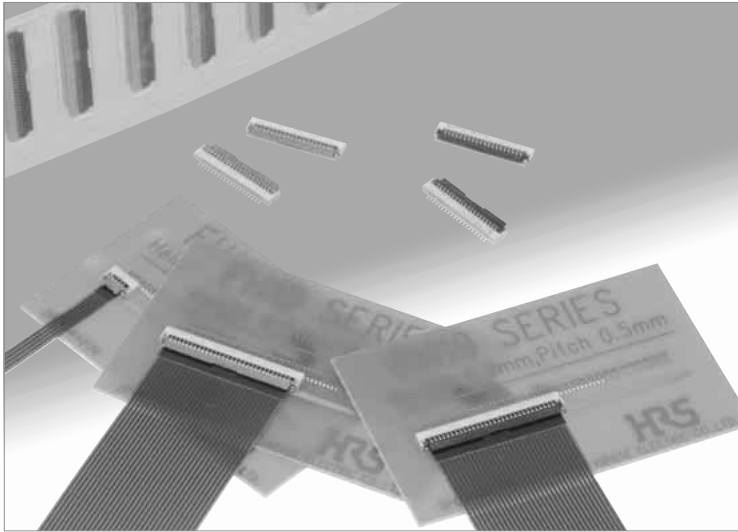
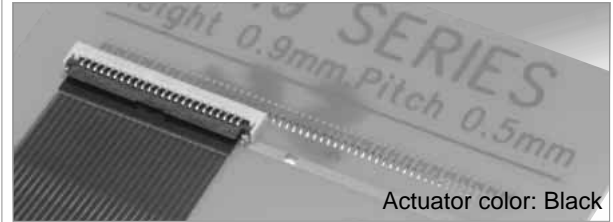

■ Features

1. Low-profile 0.5mm pitch FPC/FFC Connectors

Miniaturization of portable equipment and personal mobile devices has created increased demand for a low profile, high density, and high reliability connectors.

*The design of this connector has been made thinner and smaller, with a height of 0.9mm and width of 3mm.

*PCB footprint: Reduced approximately 48% (as compared with Hirose Electric's 0.5mm pitch FH12 Series connectors)

*Connector weight: Reduced approximately 78% (as compared with Hirose Electric's 0.5mm pitch FH12 Series connectors)

2. Conductive traces on the PCB can run under the connector

All bottom surface of the connector is solid, without any exposure of the contact.

3. Proven Flip-Lock Actuator System assures easy and reliable operation

Rotating actuator permits easy insertion and reliable connection with the FPC & FFC.

Tactile sensation confirms complete mechanical locking of the actuator and the electrical connection.

4. Accepts 0.2mm & 0.3mm thick FPC/FFC

No exposed contacts on the bottom of the connector.

The connector will also terminate with 0.2mm thick Flat Flexible Cable (FFC).

5. Board placement with automatic equipment

Flat upper surface and tape and reel packaging facilitate vacuum pick-up and placement. Standard reel packaging contains 5000 connectors.

6. Halogen-free * (FH19C, FH19SC(11 to 50pos.))

*As defined by IEC61249-2-21

Br-900ppm maximum, Cl-900ppm maximum,

● 0.9mm high

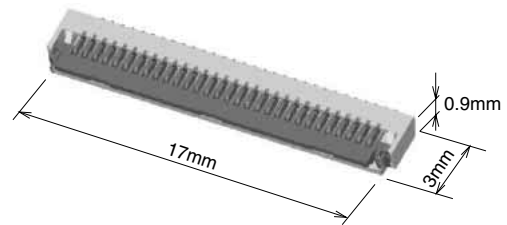

● Can be mounted over conductive traces

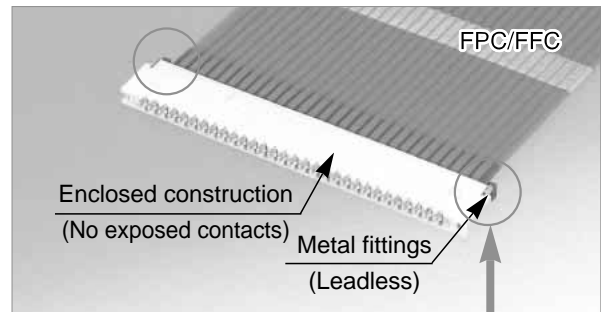

● Metal Fittings (Leadless Type)

No protrusions on the sides allows close side-by-side board placement.



● Actuator Temporary Hold Mechanism

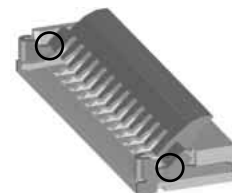

Actuator stays open during insertion of the FPC/FFC.

Product Specifications

Rating	Current rating 0.5 A (Note1)	Operating temperature range -55°C to +85°C (Note 2)	Storage temperature range -10°C to +50°C (Note 3)
	Voltage rating 50 V AC	Operating humidity range Relative humidity 90% max. (No condensation)	Storage humidity range Relative humidity 90% max. (No condensation)

Recommended FPC, FFC	FH19C Series	Thickness: = 0.2 ± 0.03mm Gold plated
	FH19SC Series	Thickness: = 0.3 ± 0.03mm Gold plated

Item	Specification	Conditions
1. Insulation resistance	500 M ohms min.	100 V DC
2. Withstanding voltage	No flashover or insulation breakdown	150 V AC/1 minute
3. Contact resistance	100 m ohms max. *Including FPC/FFC conductor resistance	1 mA
4. Durability (insertion/ withdrawal)	Contact resistance: 100 m ohms max. No damage, cracks, or parts dislocation.	20 cycles
5. Vibration	No electrical discontinuity of 1 μs or more. Contact resistance: 100 m ohms max. No damage, cracks, or parts dislocation.	Frequency: 10 to 55 Hz, single amplitude of 0.75mm, 10 cycles in each of the 3 directions
6. Shock	No electrical discontinuity of 1 μs. min. Contact resistance: 100 m ohms max. No damage, cracks, or parts dislocation.	Acceleration of 981 m/s ² , 6 ms duration, sine half-wave waveform, 3 cycles in each of the 3 axis.
7. Humidity (Steady state)	Contact resistance: 100 m ohms max. Insulation resistance: 100 M ohms min. No damage, cracks, or parts dislocation.	96 hours at temperature of 40°C and humidity of 90 to 95%
8. Temperature cycle	Contact resistance: 100 m ohms max. Insulation resistance: 100 M ohms min. No damage, cracks, or parts dislocation.	Temperature: -55°C → +15°C to +35°C → +85°C → +15°C to +35°C Time : 30 → 2 to 3 → 30 → 2 to 3 (Minutes) 5 cycles
9. Resistance to soldering heat	No deformation of components affecting performance.	Reflow: At the recommended temperature profile Manual soldering: 350°C±5°C for 5 seconds

Note 1: When passing the current through all of the contacts, use 70% of the current rating.

Note 2: Includes temperature rise caused by current flow.

Note 3: The term "storage" refers to products stored for long period of time prior to mounting and use. Operating Temperature Range and Humidity range covers non- conducting condition of installed connectors in storage, shipment or during transportation. Information

Note 4: Information contained in this catalog represents general requirements for this Series. Contact us for the drawings and specifications for a specific part number shown.

Materials

Part	Material	Finish	Remarks
Insulator	LCP	Color: Beige	UL94V-0
Actuator	PPS/LCP	Color: Brown (FH19C Series) Color: Black (FH19SC Series)	
Contacts	Phosphor bronze	Gold plated	—
Metal fittings	Phosphor bronze	Pure tin reflow plated	—

Ordering information

FH 19 C - 30S - 0.5 SH (05)
 ① ② ③ ④ ⑤ ⑥ ⑦

① Series name : FH	⑤ Contact pitch : 0.5mm																													
② Series No. : 19	⑥ Terminal type SH: SMT horizontal mounting type																													
③ C : FPC/FFC thickness : 0.2mm SC : FPC/FFC thickness : 0.3mm	⑦ Material and plating specifications :																													
④ No. of contacts : 4 to 50																														
<table border="1" style="width: 100%;"> <thead> <tr> <th colspan="2">Actuator material</th> <th>PPS</th> <th>LCP</th> <th>Halogen Free</th> </tr> </thead> <tbody> <tr> <td rowspan="2">FH19C</td> <td>Contact: Gold plated</td> <td>—</td> <td>(05)</td> <td rowspan="2">YES</td> </tr> <tr> <td>Contact: Gold plating with nickel barrier</td> <td>—</td> <td>(10)</td> </tr> <tr> <td rowspan="2">FH19SC</td> <td>Contact: Gold plated</td> <td>(05)</td> <td>—</td> <td rowspan="2">NO</td> </tr> <tr> <td>Contact: Gold plating with nickel barrier</td> <td>(06)</td> <td>—</td> </tr> <tr> <td rowspan="2">4 to 10 pos.</td> <td>Contact: Gold plated</td> <td>—</td> <td>(05)</td> <td rowspan="2">YES</td> </tr> <tr> <td>Contact: Gold plating with nickel barrier</td> <td>—</td> <td>(09)</td> </tr> </tbody> </table>		Actuator material		PPS	LCP	Halogen Free	FH19C	Contact: Gold plated	—	(05)	YES	Contact: Gold plating with nickel barrier	—	(10)	FH19SC	Contact: Gold plated	(05)	—	NO	Contact: Gold plating with nickel barrier	(06)	—	4 to 10 pos.	Contact: Gold plated	—	(05)	YES	Contact: Gold plating with nickel barrier	—	(09)
Actuator material		PPS	LCP	Halogen Free																										
FH19C	Contact: Gold plated	—	(05)	YES																										
	Contact: Gold plating with nickel barrier	—	(10)																											
FH19SC	Contact: Gold plated	(05)	—	NO																										
	Contact: Gold plating with nickel barrier	(06)	—																											
4 to 10 pos.	Contact: Gold plated	—	(05)	YES																										
	Contact: Gold plating with nickel barrier	—	(09)																											

■Connector Dimension

[FH19C Series]

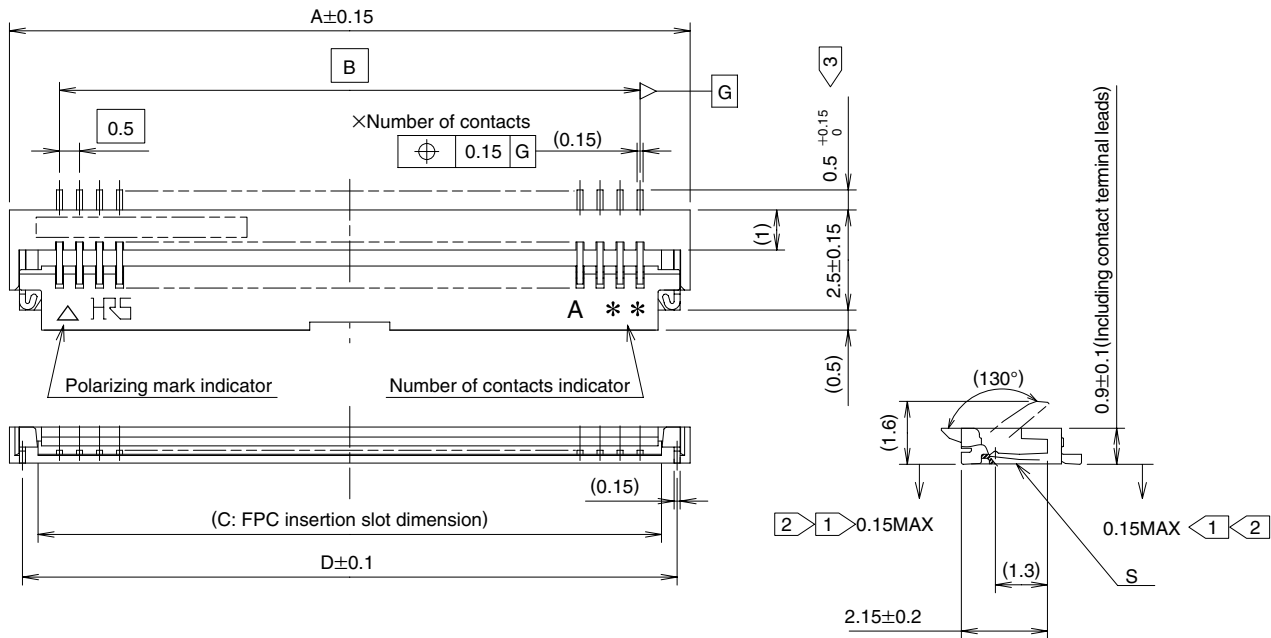

- Notes
- ① The coplanarity of each terminal lead and metal fitting is within 0.1
 - ② The contact terminal lead position indicates the dimension from the bottom surface of the insulator body.
 - ③ Difference between terminal contact to be max. 0.1mm.
 - 4 Packaged on tape and reel only. Check packaging specification.
 - 5 Any discoloration of the plastic compound will NOT AFFECT form, fit or function of the connector.
 - 6 After reflow, the terminal plating may change color, however this does not represent a quality issue.

Unit: mm

Part Number	CL No.	Number of Contacts	A	B	C	D
FH19C- 4S-0.5SH(**)	580-0410-1-*	4	4	1.5	2.57	3.35
FH19C- 5S-0.5SH(**)	580-0418-3-*	5	4.5	2	3.07	3.85
FH19C- 6S-0.5SH(**)	580-0409-2-*	6	5	2.5	3.57	4.35
FH19C- 7S-0.5SH(**)	580-0411-4-*	7	5.5	3	4.07	4.85
FH19C- 8S-0.5SH(**)	580-0404-9-*	8	6	3.5	4.57	5.35
FH19C- 9S-0.5SH(**)	580-0403-6-*	9	6.5	4	5.07	5.85
FH19C-10S-0.5SH(**)	580-0412-7-*	10	7	4.5	5.57	6.35
FH19C-12S-0.5SH(**)	580-0413-0-*	12	8	5.5	6.57	7.35
FH19C-13S-0.5SH(**)	580-0405-1-*	13	8.5	6	7.07	7.85
FH19C-15S-0.5SH(**)	580-0406-4-*	15	9.5	7	8.07	8.85
FH19C-17S-0.5SH(**)	580-0408-0-*	17	10.5	8	9.07	9.85
FH19C-20S-0.5SH(**)	580-0402-3-*	20	12	9.5	10.57	11.35
FH19C-21S-0.5SH(**)	580-0414-2-*	21	12.5	10	11.07	11.85
FH19C-24S-0.5SH(**)	580-0407-7-*	24	14	11.5	12.57	13.35
FH19C-27S-0.5SH(**)	580-0401-0-*	27	15.5	13	14.07	14.85
FH19C-30S-0.5SH(**)	580-0400-8-*	30	17	14.5	15.57	16.35
FH19C-34S-0.5SH(**)	580-0419-6-*	34	19	16.5	17.57	18.35
FH19C-40S-0.5SH(**)	580-0416-8-*	40	22	19.5	20.57	21.35
FH19C-50S-0.5SH(**)	580-0417-0-*	50	27	24.5	25.57	26.35

Note1: Embossed tape reel packaging (5,000 pieces/reel).
 Order by number of reels.
 Note2: **Specification. Refer to ordering information.

[FH19SC Series]

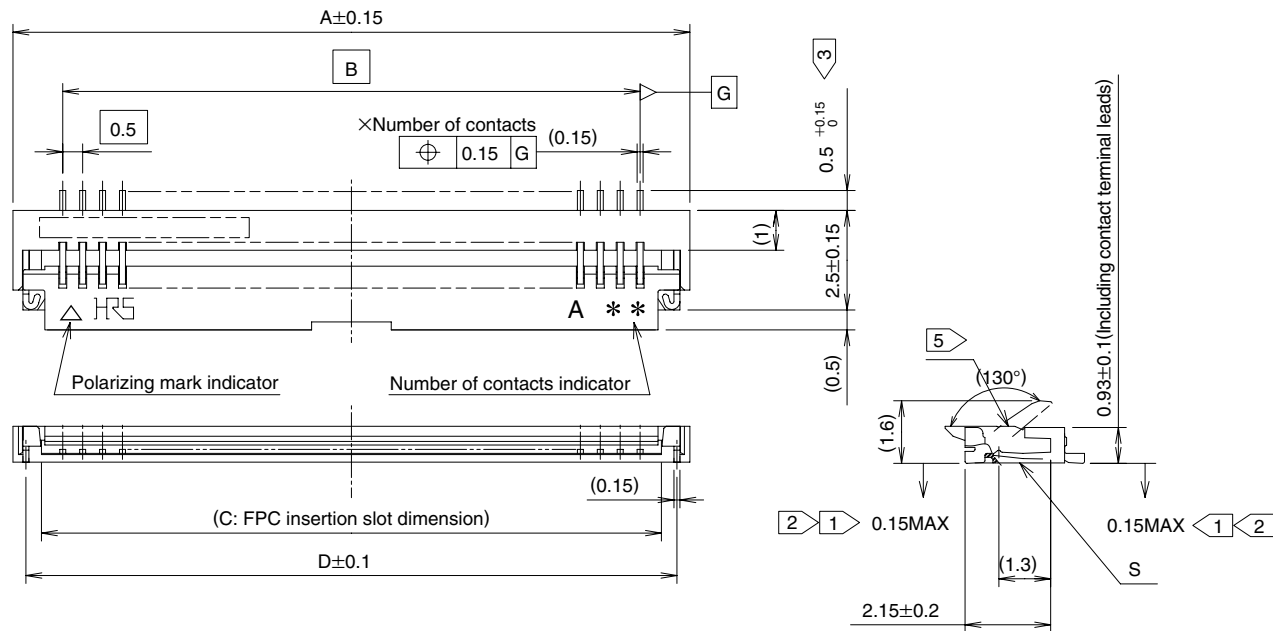

- Notes
- 1 The coplanarity of each terminal lead and metal fitting is within 0.1
 - 2 The contact terminal lead position indicates the dimension from the bottom surface of the insulator body.
 - 3 Difference between terminal contact to be max. 0.1mm.
 - 4 Any discoloration of the plastic compound will NOT AFFECT form, fit or function of the connector.
 - 5 The contacts are protruding 0.03mm max. from the housing top surface.
 - 6 Packaged on tape and reel only. Check packaging specification.
 - 7 After reflow, the terminal plating may change color, however this does not represent a quality issue.

Unit: mm

Part Number	CL No.	Number of Contacts	A	B	C	D
FH19SC- 4S-0.5SH(**)	580-0517-5-**-	4	4	1.5	2.57	3.35
FH19SC- 5S-0.5SH(**)	580-0515-0-**-	5	4.5	2	3.07	3.85
FH19SC- 6S-0.5SH(**)	580-0501-5-**-	6	5	2.5	3.57	4.35
FH19SC- 8S-0.5SH(**)	580-0520-0-**-	8	6	3.5	4.57	5.35
FH19SC- 9S-0.5SH(**)	580-0507-1-**-	9	6.5	4	5.07	5.85
FH19SC-10S-0.5SH(**)	580-0508-4-**-	10	7	4.5	5.57	6.35
FH19SC-12S-0.5SH(**)	580-0512-1-**-	12	8	5.5	6.57	7.35
FH19SC-13S-0.5SH(**)	580-0518-8-**-	13	8.5	6	7.07	7.85
FH19SC-14S-0.5SH(**)	580-0509-7-**-	14	9	6.5	7.57	8.35
FH19SC-15S-0.5SH(**)	580-0503-0-**-	15	9.5	7	8.07	8.85
FH19SC-16S-0.5SH(**)	580-0521-2-**-	16	10	7.5	8.57	9.35
FH19SC-17S-0.5SH(**)	580-0504-3-**-	17	10.5	8	9.07	9.85
FH19SC-18S-0.5SH(**)	580-0519-0-**-	18	11	8.5	9.57	10.35
FH19SC-20S-0.5SH(**)	580-0502-8-**-	20	12	9.5	10.57	11.35
FH19SC-21S-0.5SH(**)	580-0505-6-**-	21	12.5	10	11.07	11.85
FH19SC-22S-0.5SH(**)	580-0506-9-**-	22	13	10.5	11.57	12.35
FH19SC-24S-0.5SH(**)	580-0511-9-**-	24	14	11.5	12.57	13.35
FH19SC-26S-0.5SH(**)	580-0510-6-**-	26	15	12.5	13.57	14.35
FH19SC-27S-0.5SH(**)	580-0516-2-**-	27	15.5	13	14.07	14.85
FH19SC-28S-0.5SH(**)	580-0513-4-**-	28	16	13.5	14.57	15.35
FH19SC-30S-0.5SH(**)	580-0500-2-**-	30	17	14.5	15.57	16.35
FH19SC-32S-0.5SH(**)	580-0514-7-**-	32	18	15.5	16.57	17.35
FH19SC-40S-0.5SH(**)	580-0522-5-**-	40	22	19.5	20.57	21.35
FH19SC-45S-0.5SH(**)	580-0523-8-**-	45	24.5	22	23.07	23.85
FH19SC-50S-0.5SH(**)	580-0524-0-**-	50	27	24.5	25.57	26.35

Note1: Embossed tape reel packaging (5,000 pieces/reel) .

Order by number of reels.

Note2: **Specification. Refer to ordering information.

Recommended PCB Land and Metal Mask Dimensions

[Common to FH19C & FH19SC Series]

Recommended metal mask thickness: 0.10 mm.

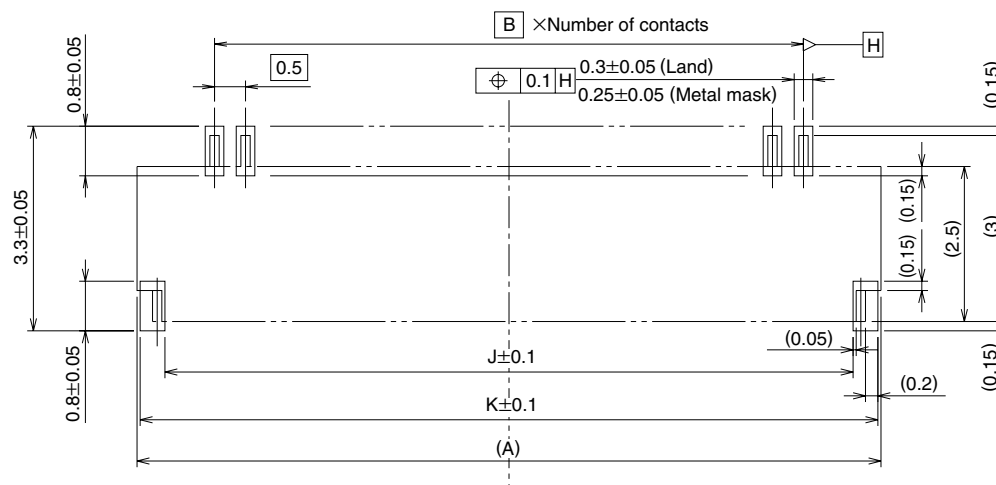

Recommended FPC, FFC Dimensions

[Common to FH19C & FH19SC Series]

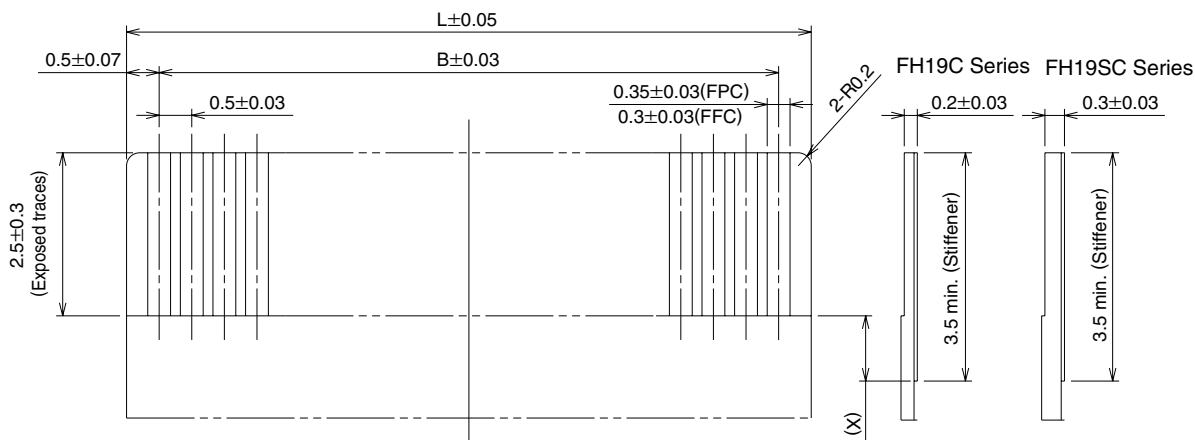

Note 1: Stiffener dimension should be 3.5mm min., and X dimension should be 0.5mm for improved flexibility of FPC.

Unit: mm

Number of Contacts	A	B	J	K	L
4	4.0	1.5	3.1	3.9	2.5
5	4.5	2.0	3.6	4.4	3.0
6	5.0	2.5	4.1	4.9	3.5
7	5.5	3.0	4.6	5.4	4.0
8	6.0	3.5	5.1	5.9	4.5
9	6.5	4.0	5.6	6.4	5.0
10	7.0	4.5	6.1	6.9	5.5
12	8.0	5.5	7.1	7.9	6.5
13	8.5	6.0	7.6	8.4	7.0
14	9.0	6.5	8.1	8.9	7.5
15	9.5	7.0	8.6	9.4	8.0
16	10.0	7.5	9.1	9.9	8.5
17	10.5	8.0	9.6	10.4	9.0
18	11.0	8.5	10.1	10.9	9.5

Unit: mm

Number of Contacts	A	B	J	K	L
20	12.0	9.5	11.1	11.9	10.5
21	12.5	10.0	11.6	12.4	11.0
22	13.0	10.5	12.1	12.9	11.5
24	14.0	11.5	13.1	13.9	12.5
26	15.0	12.5	14.1	14.9	13.5
27	15.5	13.0	14.6	15.4	14.0
28	16.0	13.5	15.1	15.9	14.5
30	17.0	14.5	16.1	16.9	15.5
32	18.0	15.5	17.1	17.9	16.5
34	19.0	16.5	18.1	18.9	17.5
40	22.0	19.5	21.1	21.9	20.5
45	24.5	22.0	23.6	24.4	23.0
50	27.0	24.5	26.1	26.9	25.5

■FH19C & FH19SC Series FPC/FFC Construction (Recommended Specifications)

1. Using Single-sided FPC

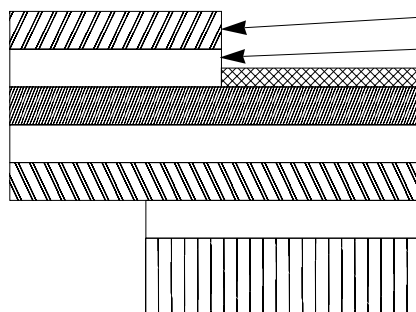

FPC : Flexible Printed Circuit

Material Name	Material	Thickness (μm)	
		FH19C	FH19SC
Covering layer film	Polyimide 1 mil thick	(25)	(25)
Cover adhesive		(25)	(25)
Surface treatment	Nickel under plated 1 to $5\mu\text{m}$ / Gold plated $0.2\mu\text{m}$	3	3
Copper foil	Cu 1oz	35	35
Base adhesive	Thermosetting adhesive	25	25
Base film	Polyimide 1 mil thick	25	25
Reinforcement material adhesive	Thermosetting adhesive	30	30
Stiffener	Polyimide FH19C : 3mil FH19SC : 7mil	75	175
Total		193	293

2. Using Double-sided FPC

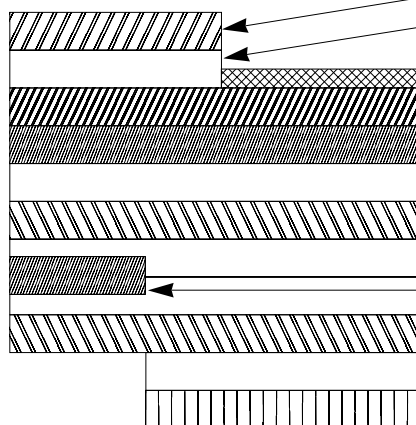

FPC : Flexible Printed Circuit

Material Name	Material	Thickness (μm)	
		FH19C	FH19SC
Covering layer film	Polyimide 1 mil thick	(25)	(25)
Cover adhesive		(25)	(25)
Surface treatment	Nickel under plated 1 to $5\mu\text{m}$ / Gold plated $0.2\mu\text{m}$	3	3
Through-hole copper	Cu	15	15
Copper foil	Cu 1/2oz	18	18
Base adhesive	Thermosetting adhesive	18	18
Base film	Polyimide 1 mil thick	25	25
Base adhesive		18	18
Copper foil	Cu 1/2oz	18	18
Cover adhesive	Thermosetting adhesive	25	25
Covering layer film	Polyimide 1 mil thick	25	25
Reinforcement material adhesive	Thermosetting adhesive	25	50
Stiffener	Polyimide FH19C : 1mil FH19SC : 4mil	25	100
Total		197	297

3. Using FFC (Flexible Flat Cable)

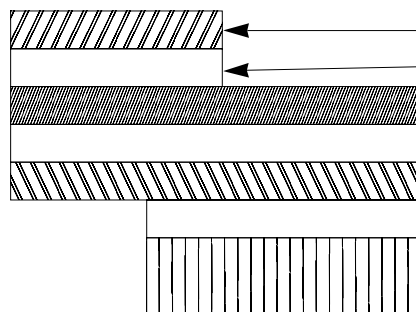

FFC : Flexible Flat Cable

Material Name	Material	Thickness (μm)	
		FH19C	FH19SC
Polyester film		(12)	(12)
Adhesive	Polyester thermoplastic type	(30)	(30)
(Nickel under plated / Gold plated), soft copper film		35	35
Adhesive	Polyester	30	30
Polyester		12	12
Adhesive	Polyester	30	30
Stiffener	Polyester	100	188
Total		207	295

* Practical tolerance of thickness dimension is $\pm 20\mu\text{m}$ (i.e., 187 to $227\mu\text{m}$).

4. Precautions

1. This specification is a recommendation for the construction of the FH19C/ Series FPC and FFC ($t=0.2\pm 0.03$).
2. For details about the construction, please contact the FPC/FFC manufacturers.

■ Packaging Specifications

[Common to FH19C & FH19SC Series]

● Embossed Carrier Tape Dimensions

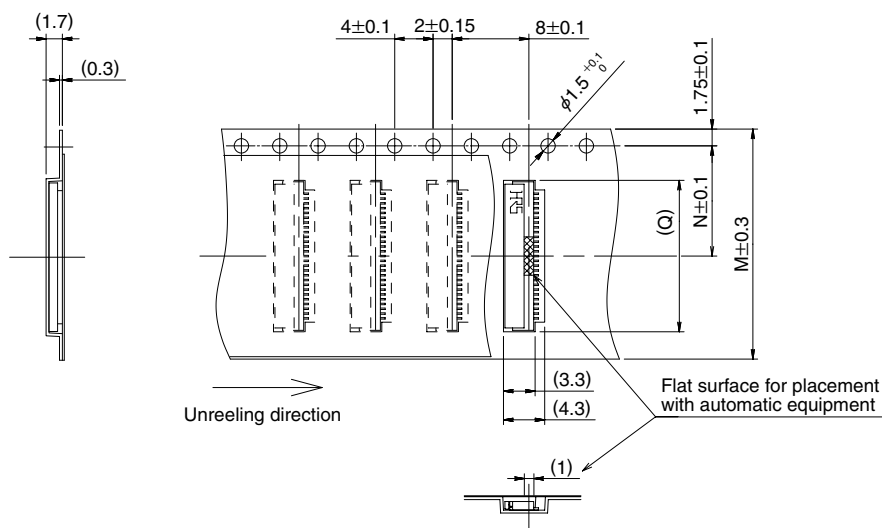

● Reel Dimensions

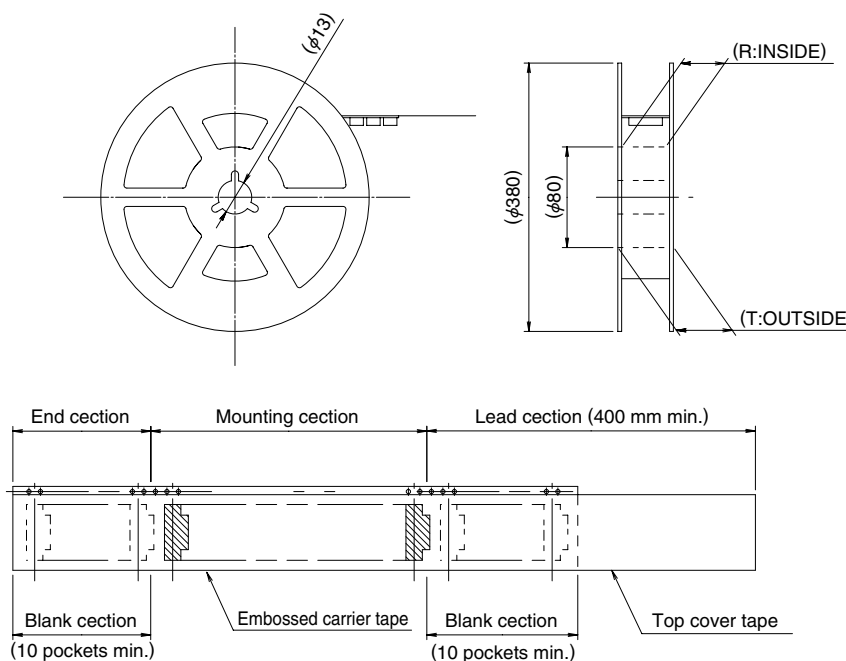

Unit: mm

Number of Contacts	M	N	Q	R	T
4	16	7.5	4.3	17.4	21.4
5	16	7.5	4.8	17.4	21.4
6	16	7.5	5.3	17.4	21.4
7	16	7.5	5.8	17.4	21.4
8	16	7.5	6.3	17.4	21.4
9	16	7.5	6.8	17.4	21.4
10	16	7.5	7.3	17.4	21.4
12	16	7.5	8.3	17.4	21.4
13	16	7.5	8.8	17.4	21.4
14	16	7.5	9.3	17.4	21.4
15	16	7.5	9.8	17.4	21.4
16	24	11.5	10.3	25.4	29.4
17	24	11.5	10.8	25.4	29.4
18	24	11.5	11.3	25.4	29.4

Unit: mm

Number of Contacts	M	N	Q	R	T
20	24	11.5	12.3	25.4	29.4
21	24	11.5	12.8	25.4	29.4
22	24	11.5	13.3	25.4	29.4
24	24	11.5	14.3	25.4	29.4
26	24	11.5	15.3	25.4	29.4
27	24	11.5	15.8	25.4	29.4
28	24	11.5	16.3	25.4	29.4
30	24	11.5	17.3	25.4	29.4
32	32	14.2	18.3	33.4	37.4
34	32	14.2	19.3	33.4	37.4
40	44	20.2	22.3	45.4	49.4
45	44	20.2	24.8	45.4	49.4
50	44	20.2	27.3	45.4	49.4

Note: 5,000 pieces per reel.

Embossed tape 32 mm or wider will have perforated feed holes on two sides.

■ Recommended Temperature Profile

[For FH19C & FH19SC Series]

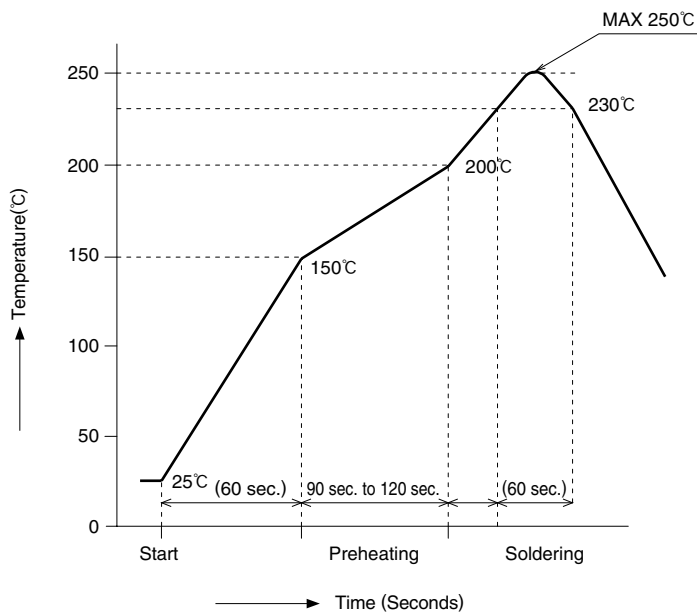

HRS test condition

Solder method	:Reflow, IR/hot air
Solder composition	:Paste, 96.5%Sn/3.0%Ag/0.5%Cu (Senju Metal Industry, Co., Ltd.'s Part Number:M705-221CM5-32-10.5)
Test board	:Glass epoxy 45mm×100mm×1.6mm thick
Land dimensions	:0.3mm×0.8mm
Metal mask	:0.25mm×0.8mm×0.1mm

This temperature profile is based on the above conditions. In individual applications the actual temperature may vary, depending on solder paste type, volume/thickness and board size/thickness. Consult your solder paste and equipment manufacturer for specific recommendations.

■ Operation and Precautions

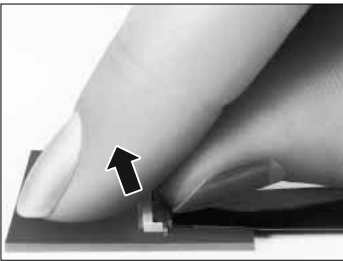
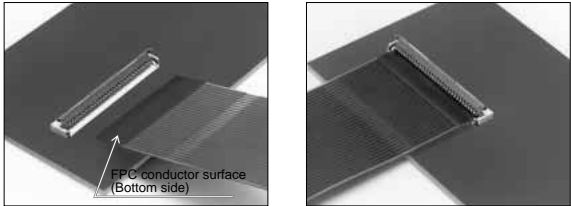
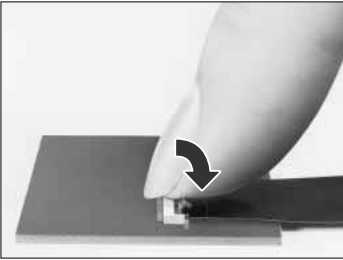
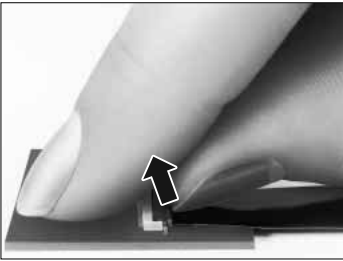
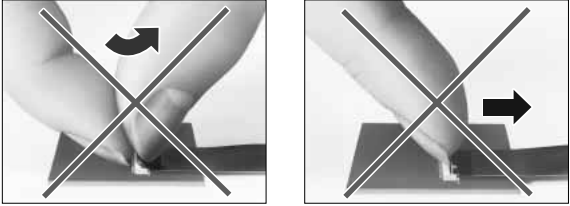
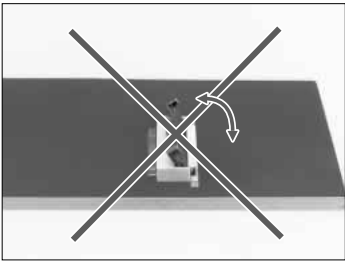
Operation	Precautions
<p>1. FPC/FFC Termination procedure. Connector installed on the board.</p> <p>1) Lift up the actuator. Use thumb or index finger.</p>  <p>2) Assure that the FPC/FFC is fully inserted parallel to mounting surface, with the exposed conductive traces facing down.</p>  <p>3) Rotate down the actuator until firmly closed. It is critical that the inserted FPC/FFC is not moved and remains fully inserted. Should the FPC/FFC be moved, open the actuator and repeat the process, starting with Step 1 above.</p>  <p>2. FPC/FFC Removal</p> <p>1) Lift up the actuator.</p> <p>2) Carefully remove the FPC/FFC.</p> 	<p>1) Do not apply excessive force or use any type of tool to operate the actuator.</p>  <p>2) The connector will assure reliable performance when the actuator is open to 130° maximum. Do not exceed this angle, as this may cause permanent damage to the connector.</p>  <p>3) Application of excessive force to the inserted FPC/FFC may cause damage to connector and may affect the reliability of electrical connection. If specific application requires continuous or repeated pull or bend of the inserted FPC/FFC, assure that the forces are NOT transmitted directly to the connector.</p> 