



Description

The ICS673-01 is a low cost, high performance Phase Locked Loop (PLL) designed for clock synthesis and synchronization. Included on the chip are the phase detector, charge pump, Voltage Controlled Oscillator (VCO), and two output buffers. One output buffer is a divide by two of the other. Through the use of external reference and VCO dividers (the ICS674-01), the user can customize the clock to lock to a wide variety of input frequencies.

The ICS673-01 also has an output enable function that puts both outputs into a high-impedance state. The chip also has a power down feature which turns off the entire device.

For applications that require low jitter or jitter attenuation, see the MK2069. For a smaller package, see the ICS663.

Features

- Packaged in 16 pin SOIC (Pb-free, ROHS compliant)
- Access to VCO input and feedback paths of PLL
- VCO operating range up to 120 MHz (5V)
- Able to lock MHz range outputs to kHz range inputs through the use of external dividers
- Output Enable tri-states outputs
- Low skew output clocks
- Power Down turns off chip
- VCO predivide to feedback divider of 1 or 4
- 25 mA output drive capability at TTL levels
- Advanced, low power, sub-micron CMOS process
- Single supply +3.3 V or +5 V $\pm 10\%$ operating voltage
- Industrial temperature range available
- Forms a complete PLL, using the ICS674-01
- For better jitter performance, please use the MK1575

Block Diagram

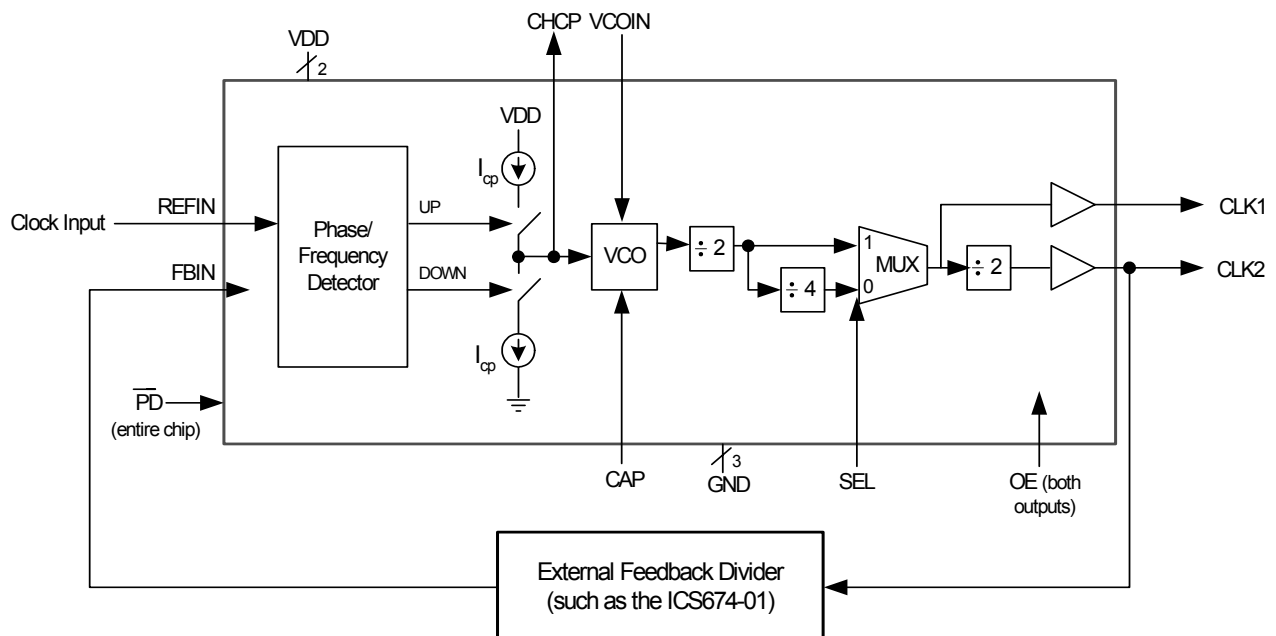



Pin Assignment

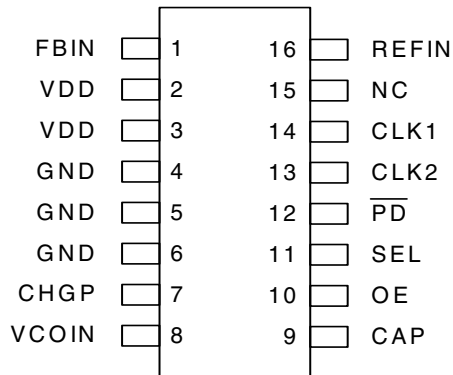

16 pin narrow (150 mil) SOIC

VCO Predivide Select Table

SEL	VCO Predivide
0	4
1	1

0 = connect pin directly to ground

1 = connect pin directly to VDD

Pin Descriptions

Pin Number	Pin Name	Pin Type	Pin Description
1	FBIN	Input	Feedback clock input. Connect the feedback clock to this pin. Falling edge triggered.
2	VDD	Power	Connect to +3.3 V or +5 V and to VDD on pin 3.
3	VDD	Power	Connect to VDD on pin 2.
4	GND	Power	Connect to ground.
5	GND	Power	Connect to ground.
6	GND	Power	Connect to ground.
7	CHGP	Output	Charge pump output. Connect to VCOIN under normal operation.
8	VCOIN	Input	Input to internal VCO.
9	CAP	Input	Loop filter return.
10	OE	Input	Output enable. Active when high. Tri-states both outputs when low.
11	SEL	Input	Select pin for VCO predivide to feedback divider per table above.
12	\overline{PD}	Input	Power down. Turns off entire chip when pin is low. Outputs stop low.
13	CLK2	Output	Clock output 2. Low skew divide by two version of CLK1.
14	CLK1	Output	Clock output 1.
15	NC	-	No connect. Nothing is connected internally to this pin.
16	REFIN	Input	Reference input. Connect reference clock to this pin. Falling edge is triggered.



Absolute Maximum Ratings

Stresses above the ratings listed below can cause permanent damage to the ICS673-01. These ratings, which are standard values for IDT commercially rated parts, are stress ratings only. Functional operation of the device at these or any other conditions above those indicated in the operational sections of the specifications is not implied. Exposure to absolute maximum rating conditions for extended periods can affect product reliability. Electrical parameters are guaranteed only over the recommended operating temperature range.

Item	Rating
Supply Voltage, VDD	7V
All Inputs and Outputs	-0.5V to VDD+0.5V
Ambient Operating Temperature	0 to +70° C
Industrial Temperature	-40 to +85° C
Storage Temperature	-65 to +150° C
Soldering Temperature	260° C

Recommended Operation Conditions

Parameter	Min.	Typ.	Max.	Units
Ambient Operating Temperature	0		+70	° C
Power Supply Voltage (measured in respect to GND)	+3.13		+5.25	V

DC Electrical Characteristics

VDD=3.3V ±5% or 5.0V ±10%, Ambient temperature -40 to +85° C, unless stated otherwise

Parameter	Symbol	Conditions	Min.	Typ.	Max.	Units
Operating Voltage	VDD		3.13		5.50	V
Logic Input High Voltage	V _{IH}	REFIN, FBIN, SEL	2			V
Logic Input Low Voltage	V _{IL}	REFIN, FBIN, SEL			0.8	V
LF Input Voltage Range	V _I		0		VDD	V
Output High Voltage	V _{OH}	I _{OH} = -25 mA	2.4			V
Output Low Voltage	V _{OL}	I _{OL} = 25mA			0.4	V
Output High Voltage, CMOS level	V _{OH}	I _{OH} = -8 mA	VDD-0.4			
Operating Supply Current	IDD	VDD = 5.0 V, No load, 40 MHz		15		mA
Short Circuit Current	I _{OS}	CLK		±100		mA
Input Capacitance	C _I	SEL		5		pF



AC Electrical Characteristics

VDD = 3.3V ±5%, Ambient Temperature -40 to +85°C, C_{LOAD} at CLK = 15 pF, unless stated otherwise

Parameter	Symbol	Conditions	Min.	Typ.	Max.	Units
Output Clock Frequency (from pin CLK)	f _{CLK}	SEL = 1	1		100	MHz
		SEL = 0	0.25		25	MHz
Input Clock Frequency (into pins REFIN or FBIN)	f _{REF}		Note 1		8	MHz
Output Rise Time	t _{OR}	0.8 to 2.0V		1.2	2	ns
Output Fall Time	t _{OF}	2.0 to 0.8V		0.75	1.5	ns
Output Clock Duty Cycle	t _{DC}	At VDD/2	40	50	60	%
Jitter, Absolute peak-to-peak	t _J			250		ps
VCO Gain	K _O			190		MHz/V
Charge Pump Current	I _{cp}			2.5		μA

VDD = 5.0V ±10%, Ambient Temperature -40 to +85°C, C_{LOAD} at CLK = 15 pF, unless stated otherwise

Parameter	Symbol	Conditions	Min.	Typ.	Max.	Units
Output Clock Frequency (from pin CLK)	f _{CLK}	SEL = 1	1		120	MHz
		SEL = 0	0.25		30	MHz
Input Clock Frequency (into pins REFIN or FBIN)	f _{REF}		Note 1		8	MHz
Output Rise Time	t _{OR}	0.8 to 2.0V		0.5	1	ns
Output Fall Time	t _{OF}	2.0 to 0.8V		0.5	1	ns
Output Clock Duty Cycle	t _{DC}	At VDD/2	45	50	55	%
Jitter, Absolute peak-to-peak	t _J			150		ps
VCO Gain	K _O			190		MHz/V
Charge Pump Current	I _{cp}			2.4		μA

Note 1: Minimum input frequency is limited by loop filter design. 1 kHz is a practical minimum limit.

External Components

The ICS673-01 requires a minimum number of external components for proper operation. A decoupling capacitor of 0.01μF should be connected between VDD and GND as close to the ICS673-01 as possible. A series termination resistor of 33 Ω may be used at the clock output.

Special considerations must be made in choosing loop components C_S and C_P. These can be found online at <http://www.idt.com>

Avoiding PLL Lockup

In some applications, the ICS673-01 can “lock up” at the maximum VCO frequency. This is usually caused by power supply glitches or a very slow power supply ramp. This situation also occurs if the external divider starts to fail at high input frequencies. The usual failure mode of a divider circuit is that the output of the divider begins to miss clock edges. The phase detector interprets this as a too low output frequency and

increases the VCO frequency. The feedback divider begins to miss even more clock edges and the VCO frequency is continually increased until it is running at its maximum frequency. Whether caused by power supply issues or by the external divider, the loop can only recover by powering down the circuit or asserting PD.

The simplest way to avoid this problem is to use an external divider that always operates correctly regardless of the VCO speed. Figures 2 and 3 show that the VCO is capable of high speeds. By using the internal divide-by-four and/or the CLK2 output, the maximum VCO frequency can be divided by 2, 4, or 8 and a slower counter can be used. Using the ICS673 internal dividers in this manner does reduce the number of frequencies that can be exactly synthesized by forcing the total VCO divide to change in increments of 2, 4, or 8.

If this lockup problem occurs, there are several solutions; three of which are described below.

1. If the system has a reset or power good signal, this should be applied to the PD pin, forcing the chip to stay powered down until the power supply voltage has stabilized
2. If no power good signal is available, a simple power-on reset circuit can be attached to the PD pin, as shown in Figure 1. When the power supply ramps up, this circuit holds PD asserted (device powered down) until the capacitor charges.

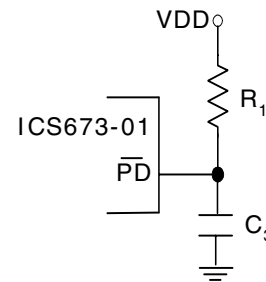

A. Basic Circuit

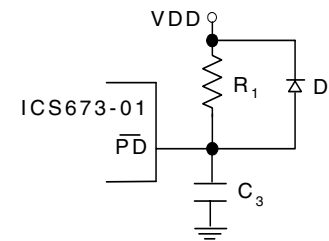

B. Faster Discharge

Fig 1. Power on Reset Circuits

The circuit of Figure 1A is adequate in most cases, but the discharge rate of capacitor C3 when VDD goes low is limited by R1. As this discharge rate determines the minimum reset time, the circuit of Figure 1B may be used when a faster reset time is desired. The values of R1 and C3 should be selected to ensure that PD stays below 1.0 V until the power supply is stable.

3. A comparator circuit may be used to monitor the loop filter voltage as shown in Figure 2. This circuit will dump the charge off the loop filter by asserting PD if the VCO begins to run too fast and the PLL can recover. A good choice for the comparator is the National Semiconductor LMC7211BIM5X. It is low power, version of the small (SOT-23), low cost, and has high input impedance.

The trigger voltage of the comparator is set by the voltage divider formed by R2 and R3. The voltage should be set to a value higher than the VCO input is expected to run during normal operation. Typically, this

might be 0.5 V below VDD. Hysteresis should be added to the circuit by connecting R4.

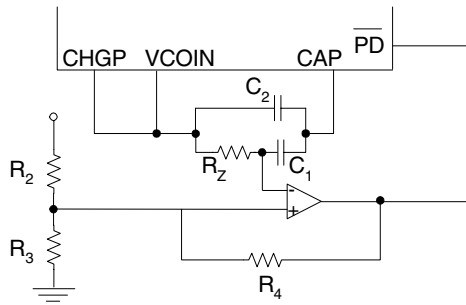

Figure 2. Using an External Comparator to Reset the VCO

The CLK output frequency may be up to 2x the maximum Output Clock Frequency listed in the AC Electrical Characteristics above when the device is in an unlocked condition. Make sure that the external divider can operate up to this frequency.

Explanation of Operation

The ICS673-01 is a PLL building block circuit that includes an integrated VCO with a wide operating range. The device uses external PLL loop filter components which through proper configuration allow for low input clock reference frequencies, such as a 15.7 kHz Hsync input.

The phase/frequency detector compares the falling edges of the clocks inputted to FBIN and REFIN. It then generates an error signal to the charge pump, which produces a charge proportional to this error. The external loop filter integrates this charge, producing a voltage that then controls the frequency of the VCO. This process continues until the edges of FBIN are aligned with the edges of the REFIN clock, at which point the output frequency will be locked to the input frequency.

Figure 3. Example Configuration -- Generating a 20 MHz clock from a 200 kHz reference.

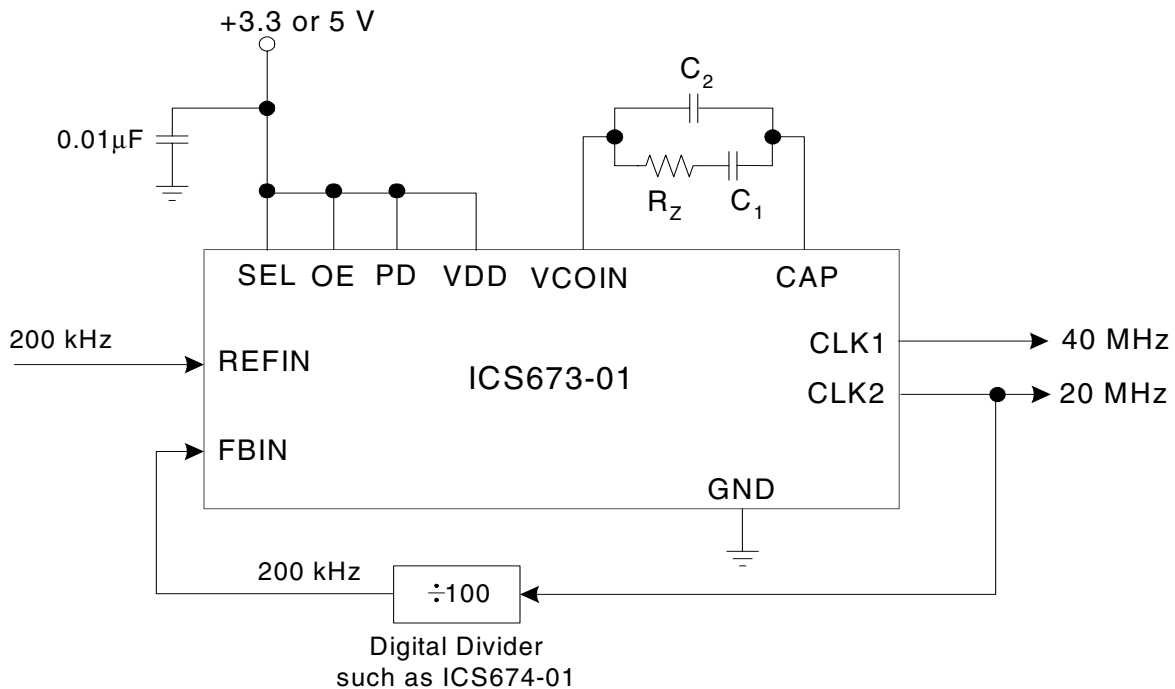



Determining the Loop Filter Values

The loop filter components consist of C_S , C_P and R_S . Calculating these values is best illustrated by an example. Using the example in Figure 1, we can synthesize 20 MHz from a 200 kHz input.

The phase locked loop may be approximately described by the following equations:

$$\text{Bandwidth } \Delta BW = \frac{R_S \cdot K_O \cdot I_{CF}}{2\pi N}$$

$$\text{Damping factor, } \zeta = \frac{R_S}{2} \sqrt{\frac{K_O \cdot I_{CP} \cdot C_S}{N}}$$

where:

- K_O = VCO gain (Hz/V)
- I_{CP} = Charge pump current (A)
- N = Total feedback divide from VCO, including the internal VCO post divider
- C_S = Loop filter capacitor (Farads)
- R_S = Loop filter resistor (Ohms)

As a general rule, the bandwidth should be at least 20 times less than the reference frequency, i.e.,
 $BW \leq (REFIN) / 20$

In this example, using the above equation, bandwidth should be less than or equal to 10 kHz. By setting the bandwidth to 10kHz and using the first equation, R_S can be determined since all other variables are known. In the example of Figure 1, $N = 200$, comprising the divide by 2 on the chip (VCO post divider) and the external divide by 100. Therefore, the bandwidth equation becomes:

$$1,000 = \frac{R_S \cdot 190 \cdot 10^6 \cdot 2.5 \cdot 10^{-6}}{2\pi \cdot 200}$$

and $R_S = 26 \text{ k}\Omega$

Choosing a damping factor of 0.7 (a minimal damping factor than can be used to ensure fast lock time), damping factor equation becomes:

$$0.7 = \frac{25,000}{2} \sqrt{\frac{190 \cdot 10^6 \cdot 2.5 \cdot 10^{-6} \cdot C_S}{200}}$$

and $C_S = 1.32 \text{ nF}$ (1.2 nF is the nearest standard value).

The capacitor C_P is used to damp transients from the charge pump and should be approximately 1/20th the size of C_S , i.e.,

$$C_P \cong C_S / 20$$

Therefore, $C_P = 60 \text{ pF}$ (56 pF nearest standard value).

To summarize, the loop filter components are:

- $C_S = 1.2 \text{ nF}$
- $C_P = 56 \text{ pF}$
- $R_S = 26 \text{ k}\Omega$

When choosing either CLK1 or CLK2 to drive the feedback divider, IDT recommends that CLK2 be used so that the rising edges of CLK1, CLK2, and REFIN are all synchronized. If CLK1 is used to feedback, CLK2 may be either a rising or falling edge when compared to CLK1 and REFIN.



Package Outline and Package Dimensions (16 pin SOIC, 150 Mil. Narrow Body)

Package dimensions are kept current with JEDEC Publication No. 95

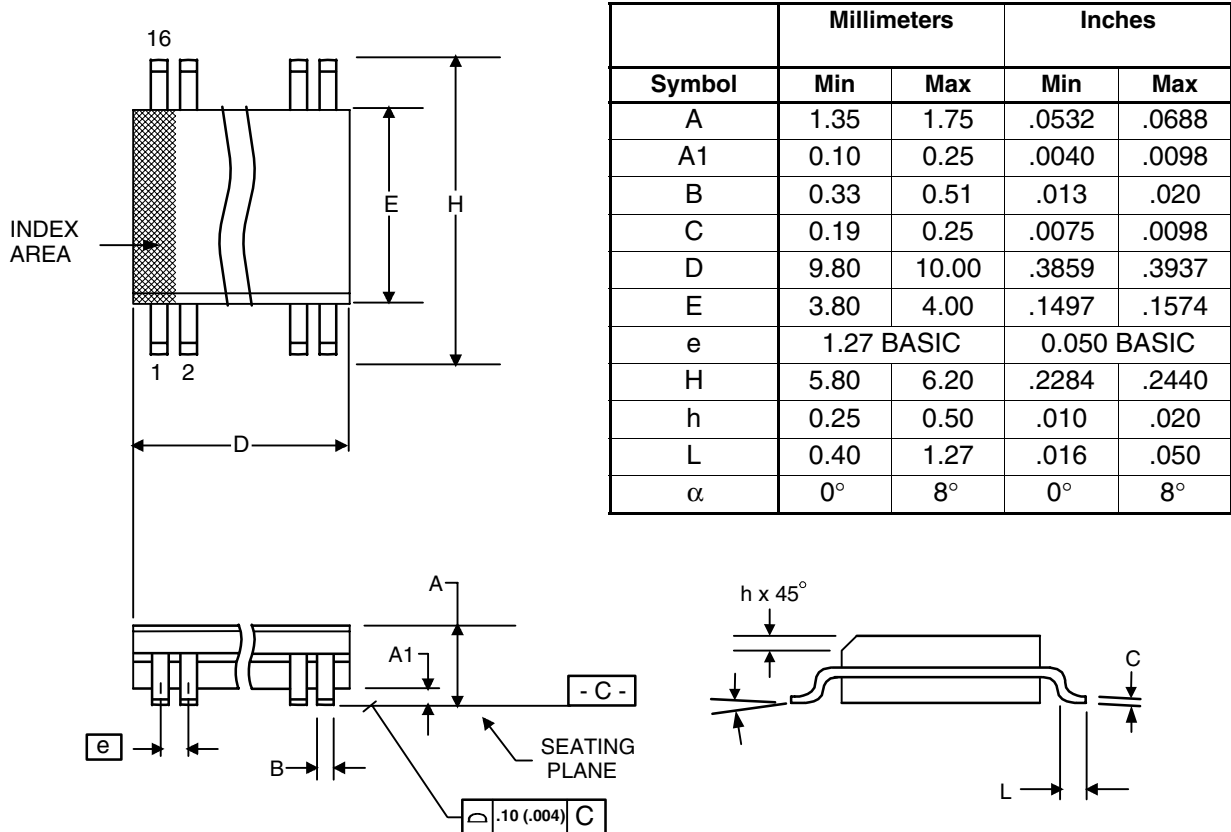

Ordering Information

Part / Order Number	Marking	Shipping packaging	Package	Temperature
673M-01ILF	673M-01IL	Tubes	16 pin SOIC	-40 to +85° C
673M-01ILFT	673M-01IL	Tape and Reel	16 pin SOIC	-40 to +85° C
673M-01LF	673M-01LF	Tubes	16 pin SOIC	0 to +70° C
673M-01LFT	673M-01LF	Tape and Reel	16 pin SOIC	0 to +70° C

“LF” denotes Pb free packaging, RoHS compliant.

While the information presented herein has been checked for both accuracy and reliability, Integrated Device Technology (IDT) assumes no responsibility for either its use or for the infringement of any patents or other rights of third parties, which would result from its use. No other circuits, patents, or licenses are implied. This product is intended for use in normal commercial applications. Any other applications such as those requiring extended temperature range, high reliability, or other extraordinary environmental requirements are not recommended without additional processing by IDT. IDT reserves the right to change any circuitry or specifications without notice. IDT does not authorize or warrant any IDT product for use in life support devices or critical medical instruments.