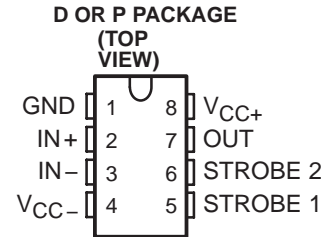


# LM306 DIFFERENTIAL COMPARATOR WITH STROBES

SLCS008A – OCTOBER 1979 – REVISED OCTOBER 1991

- Fast Response Times
- Improved Gain and Accuracy
- Fanout to 10 Series 54/74 TTL Loads
- Strobe Capability
- Short-Circuit and Surge Protection
- Designed to Be Interchangeable With National Semiconductor LM306



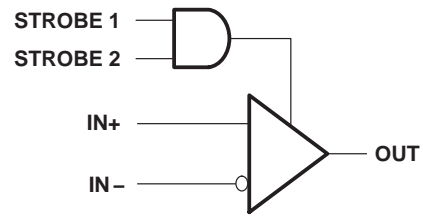
## description

The LM306 is a high-speed voltage comparator with differential inputs, a low-impedance high-sink-current (100 mA) output, and two strobe inputs. This device detects low-level analog or digital signals and can drive digital logic or lamps and relays directly. Short-circuit protection and surge-current limiting is provided.

A low-level input at either strobe causes the output to remain high regardless of the differential input. When both strobe inputs are either open or at a high logic level, the output voltage is controlled by the differential input voltage. The circuit will operate with any negative supply voltage between  $-3\text{ V}$  and  $-12\text{ V}$  with little difference in performance.

The LM306 is characterized for operation from  $0^{\circ}\text{C}$  to  $70^{\circ}\text{C}$ .

## functional block diagram



## AVAILABLE OPTIONS

$T_A$	$V_{IO\max}$ at $25^{\circ}\text{C}$	PACKAGE	
		SMALL OUTLINE (D)	PLASTIC DIP (P)
$0^{\circ}\text{C}$ to $70^{\circ}\text{C}$	5 mV	LM306D	LM306P

PRODUCTION DATA information is current as of publication date. Products conform to specifications per the terms of Texas Instruments standard warranty. Production processing does not necessarily include testing of all parameters.



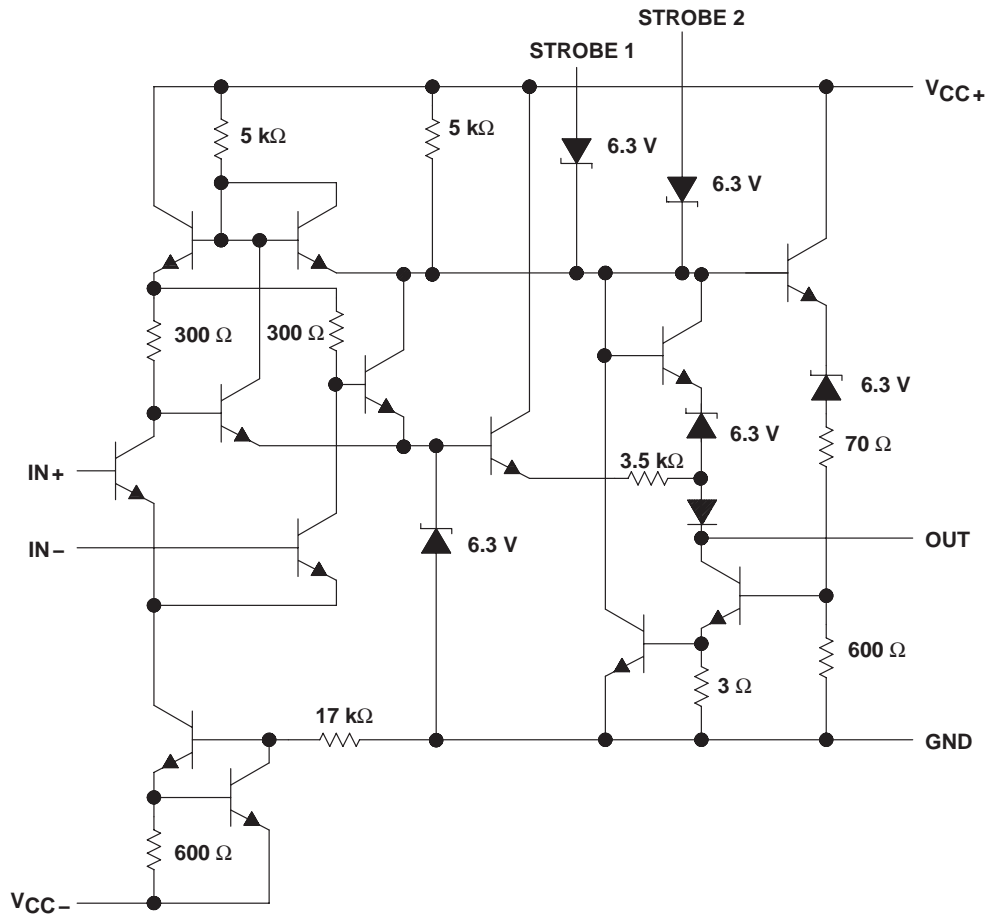
POST OFFICE BOX 655303 • DALLAS, TEXAS 75265  
POST OFFICE BOX 1443 • HOUSTON, TEXAS 77251-1443

Copyright © 1991, Texas Instruments Incorporated

# LM306 DIFFERENTIAL COMPARATOR WITH STROBES

SLCS008A – OCTOBER 1979 – REVISED OCTOBER 1991

## schematic



Resistor values are nominal.

# LM306 DIFFERENTIAL COMPARATOR WITH STROBES

SLCS008A – OCTOBER 1979 – REVISED OCTOBER 1991

## absolute maximum ratings over operating free-air temperature range (unless otherwise noted)†

Supply voltage, $V_{CC+}$ (see Note 1) .....	15 V
Supply voltage, $V_{CC-}$ (see Note 1) .....	-15 V
Differential input voltage, $V_{ID}$ (see Note 2) .....	$\pm 5$ V
Input voltage, $V_I$ (either input, see Notes 1 and 3) .....	$\pm 7$ V
Strobe voltage range (see Note 1) .....	0 V to $V_{CC+}$
Output voltage, $V_O$ (see Note 1) .....	24 V
Voltage from output to $V_{CC-}$ .....	30 V
Duration of output short circuit to ground (see Note 4) .....	10 s
Continuous total dissipation .....	See Dissipation Rating Table
Operating free-air temperature range, $T_A$ .....	$0^\circ\text{C}$ to $70^\circ\text{C}$
Storage temperature range .....	$-65^\circ\text{C}$ to $150^\circ\text{C}$
Lead temperature 1,6 mm (1/16 inch) from case for 10 seconds .....	$260^\circ\text{C}$

† Stresses beyond those listed under "absolute maximum ratings" may cause permanent damage to the device. These are stress ratings only, and functional operation of the device at these or any other conditions beyond those indicated under "recommended operating conditions" is not implied. Exposure to absolute-maximum-rated conditions for extended periods may affect device reliability.

- NOTES: 1. All voltage values, except differential voltages and the voltage from the output to  $V_{CC-}$ , are with respect to the network ground.  
 2. Differential voltages are at  $IN+$  with respect to  $IN-$ .  
 3. The magnitude of the input voltage must never exceed the magnitude of the supply voltage or 7 V, whichever is less.  
 4. The output may be shorted to ground or either power supply.

**DISSIPATION RATING TABLE**

PACKAGE	$T_A \leq 25^\circ\text{C}$ POWER RATING	DERATING FACTOR	DERATE ABOVE $T_A$	$T_A = 70^\circ\text{C}$ POWER RATING
D	600 mW	5.8 mW/ $^\circ\text{C}$	$46^\circ\text{C}$	464 mW
P	600 mW	8.0 mW/ $^\circ\text{C}$	$75^\circ\text{C}$	600 mW



# LM306

## DIFFERENTIAL COMPARATOR WITH STROBES

SLCS008A – OCTOBER 1979 – REVISED OCTOBER 1991

electrical characteristics at specified free-air temperature,  $V_{CC+} = 12\text{ V}$ ,  $V_{CC-} = -3\text{ V}$  to  $-12\text{ V}$  (unless otherwise noted)

PARAMETER		TEST CONDITIONS†		$T_A$ ‡	MIN	TYP	MAX	UNIT
$V_{IO}$	Input offset voltage	$R_S \leq 200\ \Omega$		25°C		1.6§	5	mV
				Full range			6.5	
$\alpha V_{IO}$	Average temperature coefficient of input offset voltage	$R_S = 50\ \Omega$	See Note 5	Full range		5	20	$\mu\text{V}/^\circ\text{C}$
$I_{IO}$	Input offset current	See Note 5		25°C		1.8	5	$\mu\text{A}$
				MIN		1	7.5	
				MAX		0.5	5	
$\alpha I_{IO}$	Average temperature coefficient of input offset current	See Note 5		MIN to 25°C		24	100	$\text{nA}/^\circ\text{C}$
				25°C to MAX		15	50	
$I_{IB}$	Input bias current	$V_O = 0.5\text{ V}$ to $5\text{ V}$		MIN to 25°C			40	$\mu\text{A}$
				25°C to MAX		16	25	
$I_{IL(S)}$	Low-level strobe current	$V(\text{strobe}) = 0.4\text{ V}$		Full range		-1.7	-3.2	mA
$V_{IH(S)}$	High-level strobe voltage			Full range	2.2			V
$V_{IL(S)}$	Low-level strobe voltage			Full range			0.9	V
$V_{ICR}$	Common-mode input voltage range	$V_{CC-} = -7\text{ V}$ to $-12\text{ V}$		Full range	$\pm 5$			V
$V_{ID}$	Differential input voltage range			Full range	$\pm 5$			V
$A_{VD}$	Large-signal differential voltage amplification	$V_O = 0.5\text{ V}$ to $5\text{ V}$ ,	No load	25°C		40		V/mV
$V_{OH}$	High-level output voltage	$I_{OH} = -400\ \mu\text{A}$	$V_{ID} = 8\text{ mV}$	Full range	2.5		5.5	V
$V_{OL}$	Low-level output voltage	$I_{OL} = 100\text{ mA}$	$V_{ID} = -7\text{ mV}$	25°C		0.8	2	V
		$I_{OL} = 50\text{ mA}$	$V_{ID} = -7\text{ mV}$	Full range			1	
		$I_{OL} = 16\text{ mA}$	$V_{ID} = -8\text{ mV}$	Full range				
$I_{OH}$	High-level output voltage	$V_{OH} = 8\text{ V}$ to $24\text{ V}$	$V_{ID} = 7\text{ mV}$	MIN to 25°C		0.02	2	$\mu\text{A}$
			$V_{ID} = 8\text{ mV}$	25°C to MAX				
$I_{CC+}$	Supply current from $V_{CC+}$	$V_{ID} = -5\text{ mV}$ ,	No load	Full range		6.6	10	mA
$I_{CC-}$	Supply current from $V_{CC-}$	No load		Full range		-1.9	-3.6	mA

† Unless otherwise noted, all characteristics are measured with both strobes open.

‡ Full range is 0°C to 70°C. MIN is 0°C. MAX is 70°C.

§ This typical value is at  $V_{CC+} = 12\text{ V}$ ,  $V_{CC-} = -6\text{ V}$ .

NOTE 5: The offset voltages and offset currents given are the maximum values required to drive the output down to the low range ( $V_{OL}$ ) or up to the high range ( $V_{OH}$ ). These parameters actually define an error band and take into account the worst-case effects of voltage gain and input impedance.

### switching characteristics, $V_{CC+} = 12\text{ V}$ , $V_{CC-} = -6\text{ V}$ , $T_A = 25^\circ\text{C}$

PARAMETER	TEST CONDITIONS†	MIN	TYP	MAX	UNIT
Response time, low-to-high-level output	$R_L = 390\ \Omega$ to $5\text{ V}$ , $C_L = 15\text{ pF}$ , See Note 6		28	40	ns

† All characteristics are measured with both strobes open.

NOTE 6: The response time specified is for a 100-mV input step with 5-mV overdrive and is the interval between the input step function and the instant when the output crosses 1.4 V.

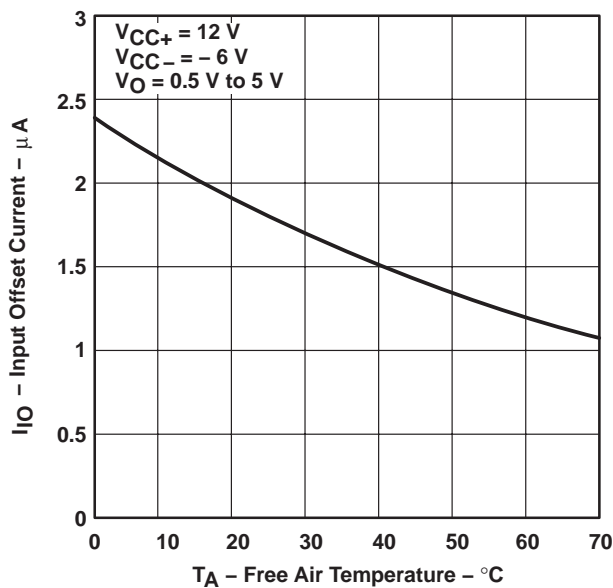


**TYPICAL CHARACTERISTICS**

**Table of Graphs**

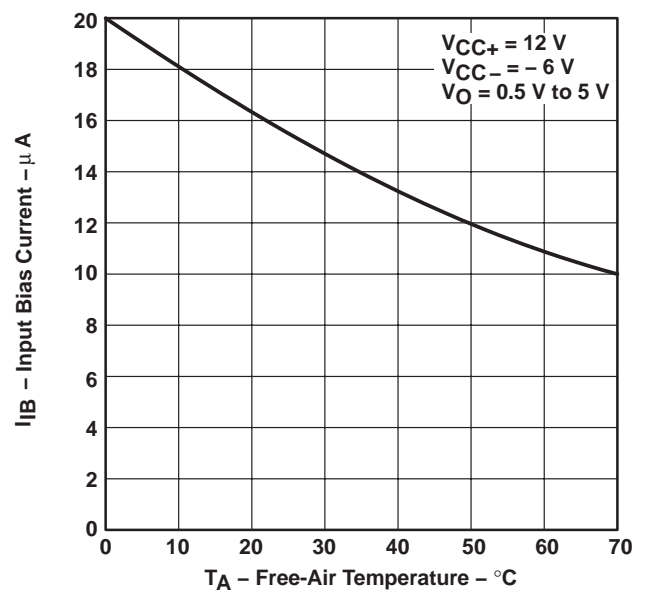
			FIGURE
$I_{IB}$	Input bias current	vs Free-air temperature	1
$I_{IO}$	Input offset current	vs Free-air temperature	2
$V_{OH}$	High-level output voltage	vs Free-air temperature	3
$V_{OL}$	Low-level output voltage	vs Free-air temperature	4
$V_O$	Output voltage	vs Differential input voltage	5
$I_O$	Output current	vs Differential input voltage	6
$A_{VD}$	Large-signal differential voltage amplification	vs Free-air temperature	7
$I_{OS}$	Short-circuit output current	vs Free-air temperature	8
	Output response	vs Time	9, 10
$I_{CC+}$	Positive supply current	vs Positive supply voltage	11
$I_{CC-}$	Negative supply current	vs Negative supply voltage	12
$P_D$	Total power dissipation	vs Free-air temperature	13

**INPUT OFFSET CURRENT  
vs  
FREE-AIR TEMPERATURE**



**Figure 1**

**INPUT BIAS CURRENT  
vs  
FREE-AIR TEMPERATURE**



**Figure 2**

# LM306 DIFFERENTIAL COMPARATOR WITH STROBES

SLCS008A – OCTOBER 1979 – REVISED OCTOBER 1991

## TYPICAL CHARACTERISTICS

HIGH-LEVEL OUTPUT VOLTAGE  
vs  
FREE-AIR TEMPERATURE

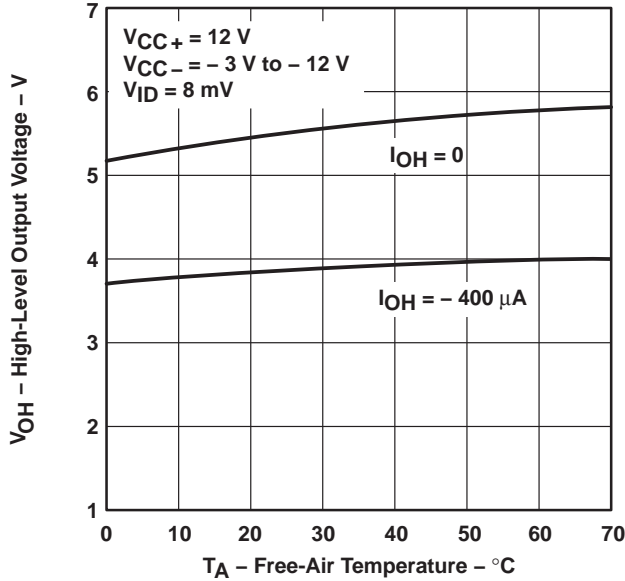


Figure 3

LOW-LEVEL OUTPUT VOLTAGE  
vs  
FREE-AIR TEMPERATURE

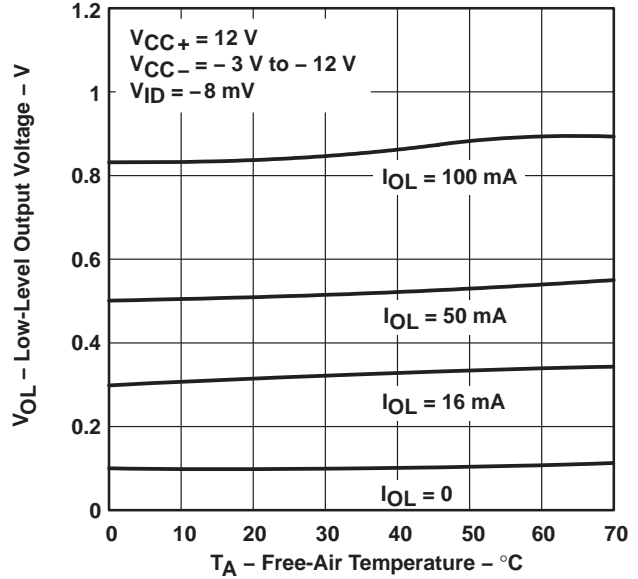


Figure 4

OUTPUT VOLTAGE  
vs  
DIFFERENTIAL INPUT VOLTAGE

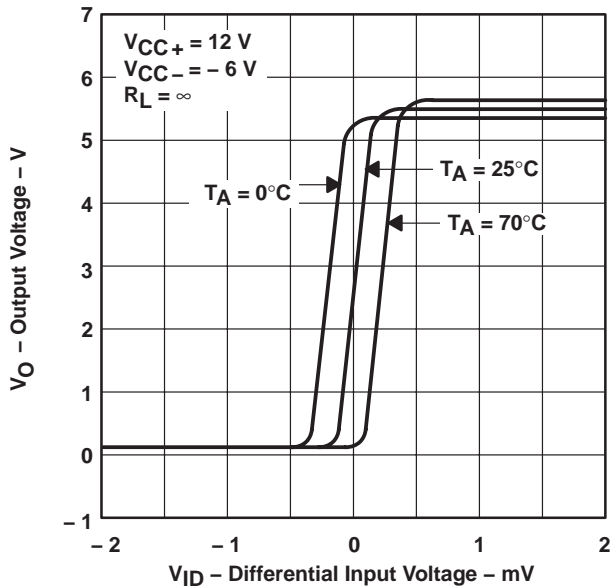


Figure 5

OUTPUT CURRENT  
vs  
DIFFERENTIAL INPUT VOLTAGE

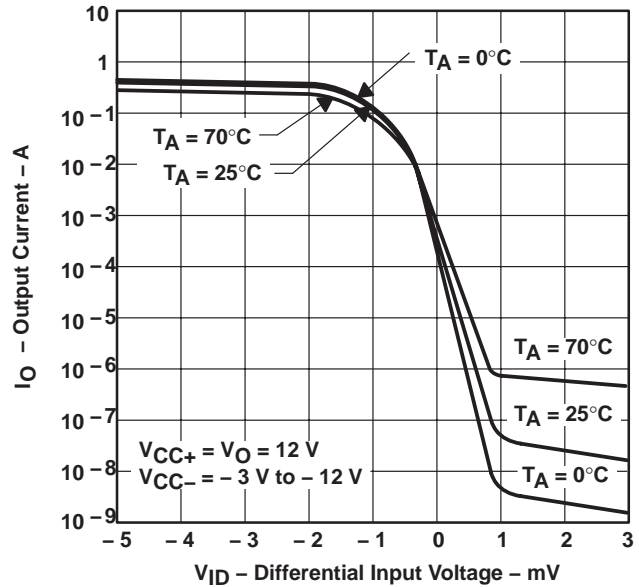
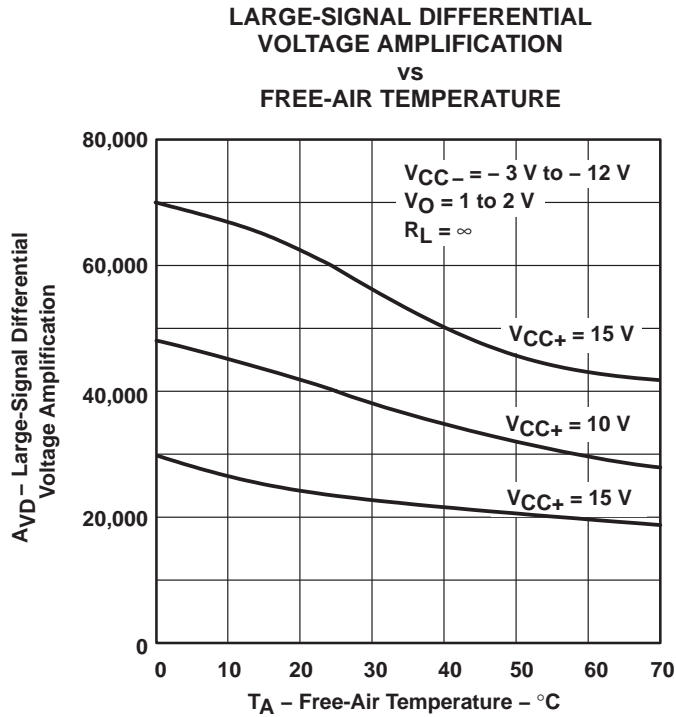


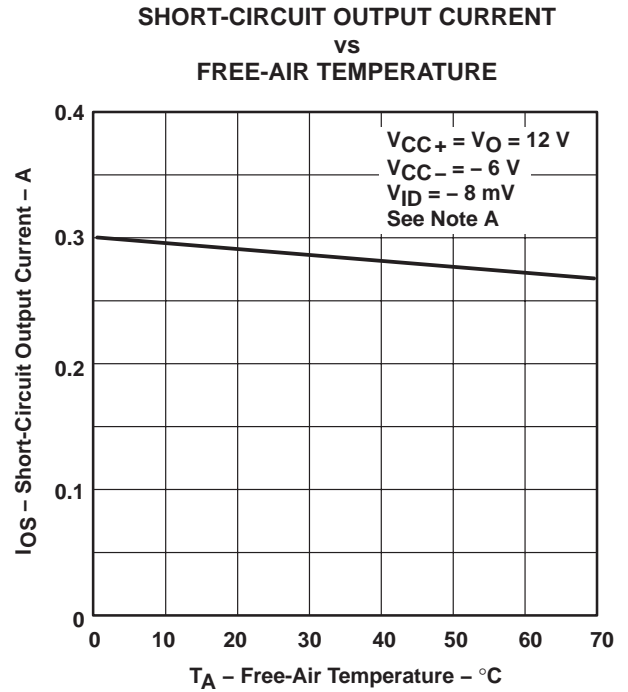
Figure 6



**TYPICAL CHARACTERISTICS**

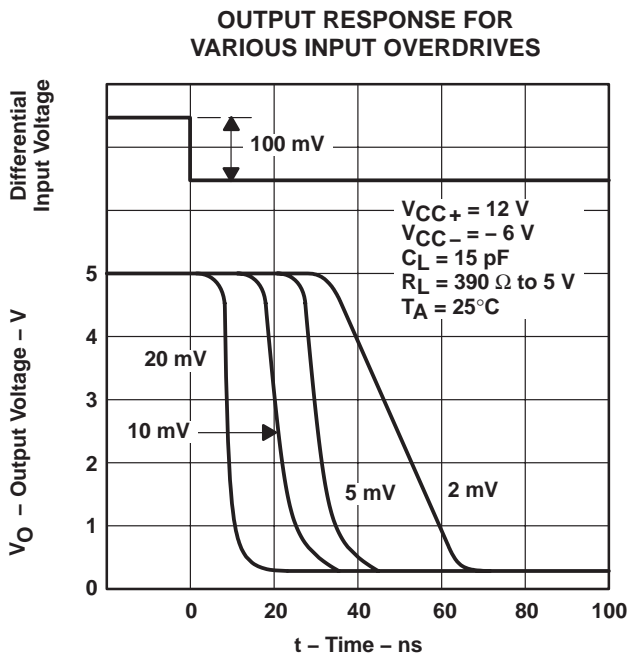


**Figure 7**

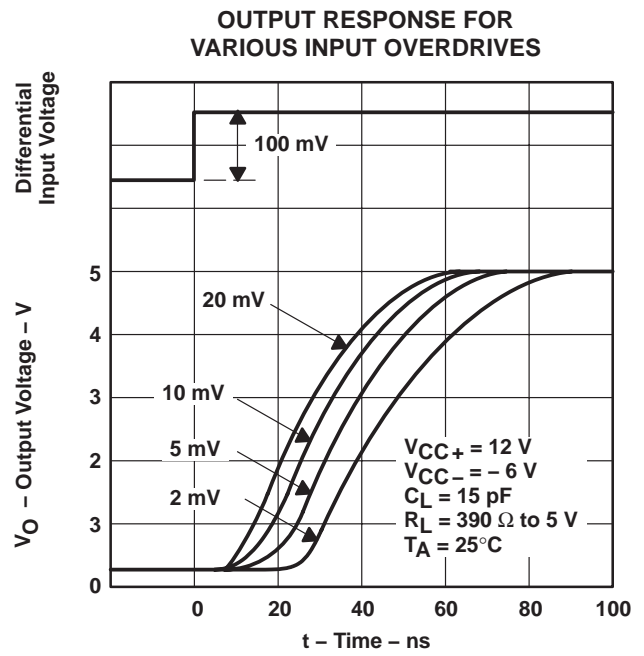


NOTE A: This parameter was measured using a single 5-ms pulse.

**Figure 8**



**Figure 9**



**Figure 10**

# LM306 DIFFERENTIAL COMPARATOR WITH STROBES

SLCS008A – OCTOBER 1979 – REVISED OCTOBER 1991

## TYPICAL CHARACTERISTICS

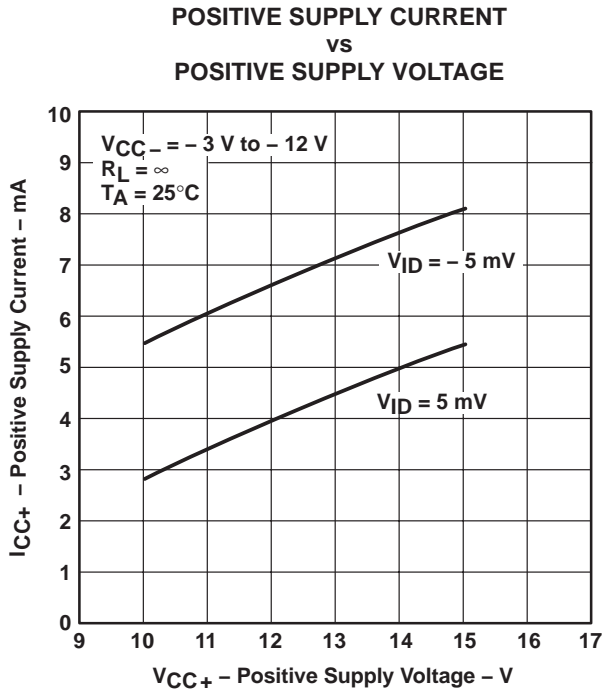


Figure 11

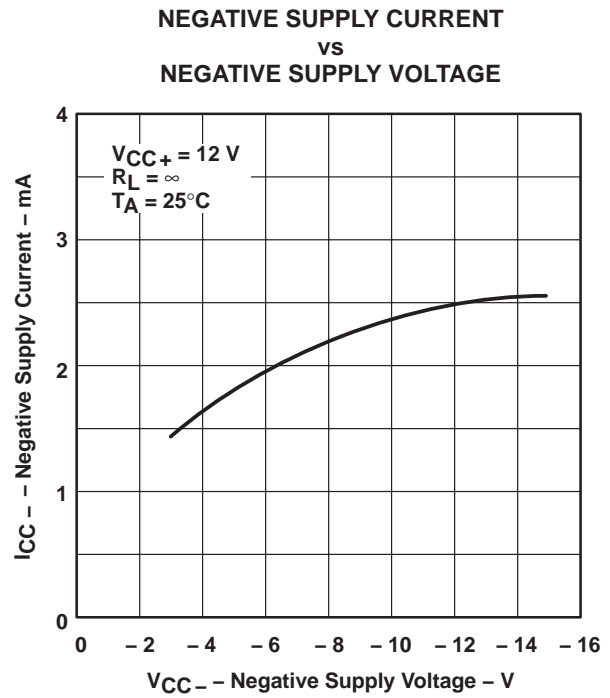


Figure 12

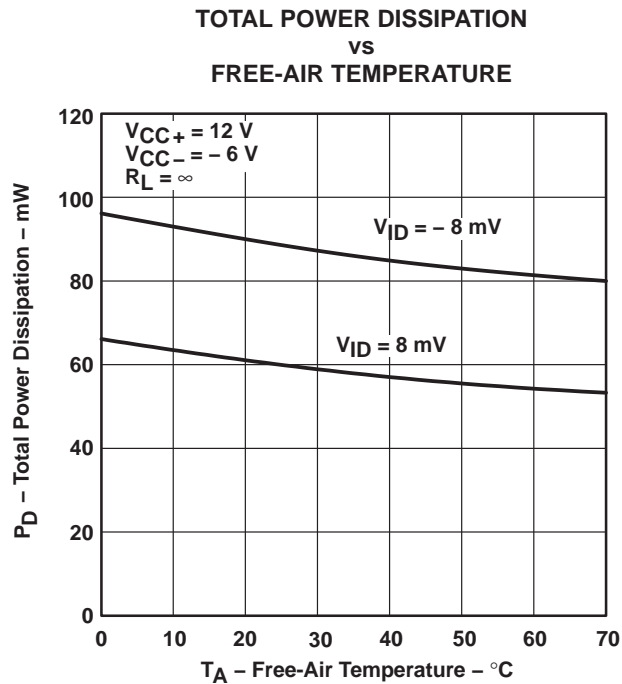


Figure 13





**PACKAGING INFORMATION**

Orderable Device	Status <sup>(1)</sup>	Package Type	Package Drawing	Pins	Package Qty	Eco Plan <sup>(2)</sup>	Lead/Ball Finish	MSL Peak Temp <sup>(3)</sup>
LM306D	ACTIVE	SOIC	D	8	75	Green (RoHS & no Sb/Br)	CU NIPDAU	Level-1-260C-UNLIM
LM306DE4	ACTIVE	SOIC	D	8	75	Green (RoHS & no Sb/Br)	CU NIPDAU	Level-1-260C-UNLIM
LM306DG4	ACTIVE	SOIC	D	8	75	Green (RoHS & no Sb/Br)	CU NIPDAU	Level-1-260C-UNLIM
LM306DR	ACTIVE	SOIC	D	8	2500	Green (RoHS & no Sb/Br)	CU NIPDAU	Level-1-260C-UNLIM
LM306DRE4	ACTIVE	SOIC	D	8	2500	Green (RoHS & no Sb/Br)	CU NIPDAU	Level-1-260C-UNLIM
LM306DRG4	ACTIVE	SOIC	D	8	2500	Green (RoHS & no Sb/Br)	CU NIPDAU	Level-1-260C-UNLIM
LM306P	ACTIVE	PDIP	P	8	50	Pb-Free (RoHS)	CU NIPDAU	N / A for Pkg Type
LM306PE4	ACTIVE	PDIP	P	8	50	Pb-Free (RoHS)	CU NIPDAU	N / A for Pkg Type

<sup>(1)</sup> The marketing status values are defined as follows:

**ACTIVE:** Product device recommended for new designs.

**LIFEBUY:** TI has announced that the device will be discontinued, and a lifetime-buy period is in effect.

**NRND:** Not recommended for new designs. Device is in production to support existing customers, but TI does not recommend using this part in a new design.

**PREVIEW:** Device has been announced but is not in production. Samples may or may not be available.

**OBSOLETE:** TI has discontinued the production of the device.

<sup>(2)</sup> Eco Plan - The planned eco-friendly classification: Pb-Free (RoHS), Pb-Free (RoHS Exempt), or Green (RoHS & no Sb/Br) - please check <http://www.ti.com/productcontent> for the latest availability information and additional product content details.

**TBD:** The Pb-Free/Green conversion plan has not been defined.

**Pb-Free (RoHS):** TI's terms "Lead-Free" or "Pb-Free" mean semiconductor products that are compatible with the current RoHS requirements for all 6 substances, including the requirement that lead not exceed 0.1% by weight in homogeneous materials. Where designed to be soldered at high temperatures, TI Pb-Free products are suitable for use in specified lead-free processes.

**Pb-Free (RoHS Exempt):** This component has a RoHS exemption for either 1) lead-based flip-chip solder bumps used between the die and package, or 2) lead-based die adhesive used between the die and leadframe. The component is otherwise considered Pb-Free (RoHS compatible) as defined above.

**Green (RoHS & no Sb/Br):** TI defines "Green" to mean Pb-Free (RoHS compatible), and free of Bromine (Br) and Antimony (Sb) based flame retardants (Br or Sb do not exceed 0.1% by weight in homogeneous material)

<sup>(3)</sup> MSL, Peak Temp. -- The Moisture Sensitivity Level rating according to the JEDEC industry standard classifications, and peak solder temperature.

**Important Information and Disclaimer:**The information provided on this page represents TI's knowledge and belief as of the date that it is provided. TI bases its knowledge and belief on information provided by third parties, and makes no representation or warranty as to the accuracy of such information. Efforts are underway to better integrate information from third parties. TI has taken and continues to take reasonable steps to provide representative and accurate information but may not have conducted destructive testing or chemical analysis on incoming materials and chemicals. TI and TI suppliers consider certain information to be proprietary, and thus CAS numbers and other limited information may not be available for release.

In no event shall TI's liability arising out of such information exceed the total purchase price of the TI part(s) at issue in this document sold by TI to Customer on an annual basis.

**TAPE AND REEL INFORMATION**



**QUADRANT ASSIGNMENTS FOR PIN 1 ORIENTATION IN TAPE**



\*All dimensions are nominal

Device	Package Type	Package Drawing	Pins	SPQ	Reel Diameter (mm)	Reel Width W1 (mm)	A0 (mm)	B0 (mm)	K0 (mm)	P1 (mm)	W (mm)	Pin1 Quadrant
LM306DR	SOIC	D	8	2500	330.0	12.4	6.4	5.2	2.1	8.0	12.0	Q1

**TAPE AND REEL BOX DIMENSIONS**

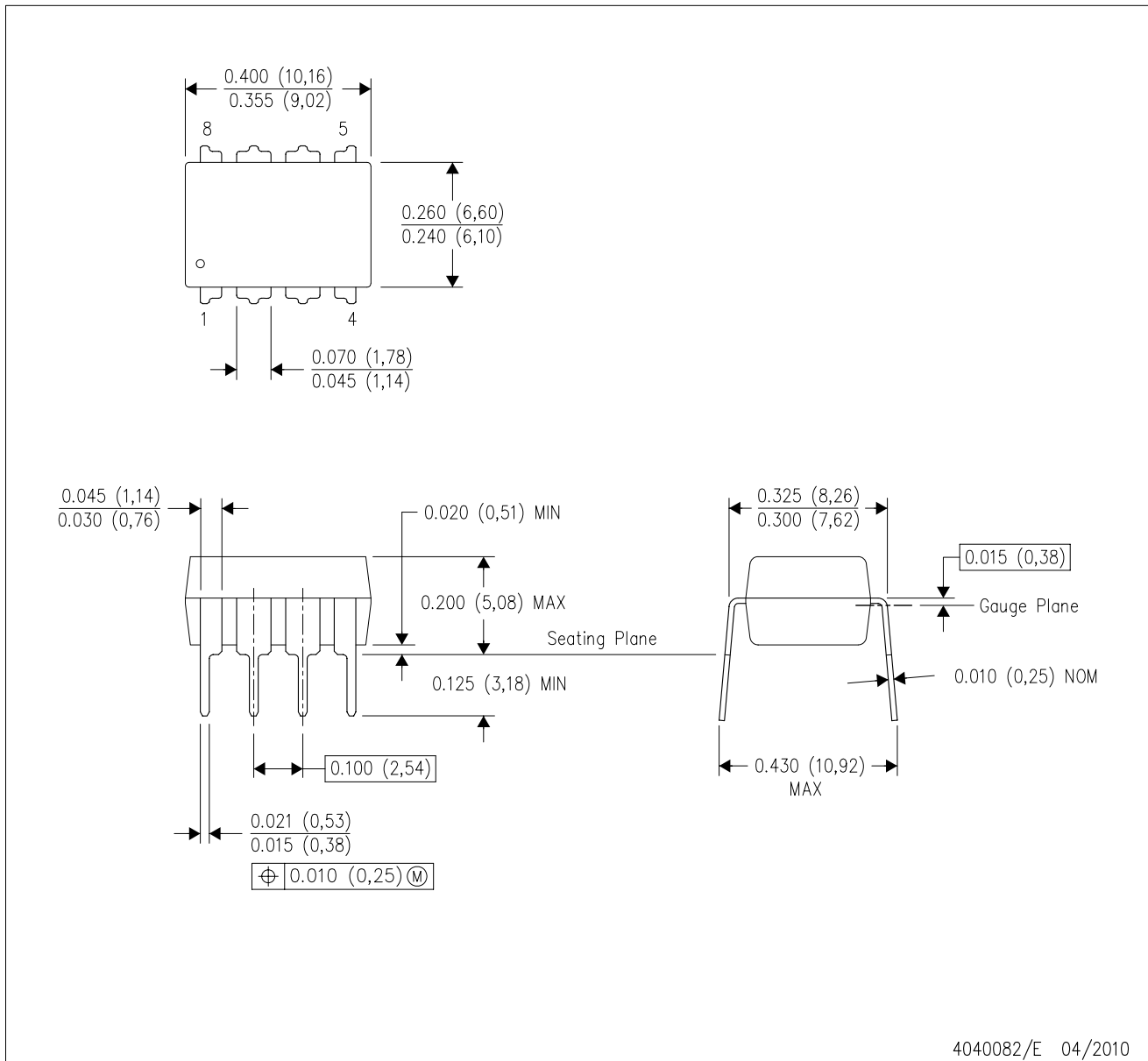


\*All dimensions are nominal

Device	Package Type	Package Drawing	Pins	SPQ	Length (mm)	Width (mm)	Height (mm)
LM306DR	SOIC	D	8	2500	340.5	338.1	20.6

P (R-PDIP-T8)

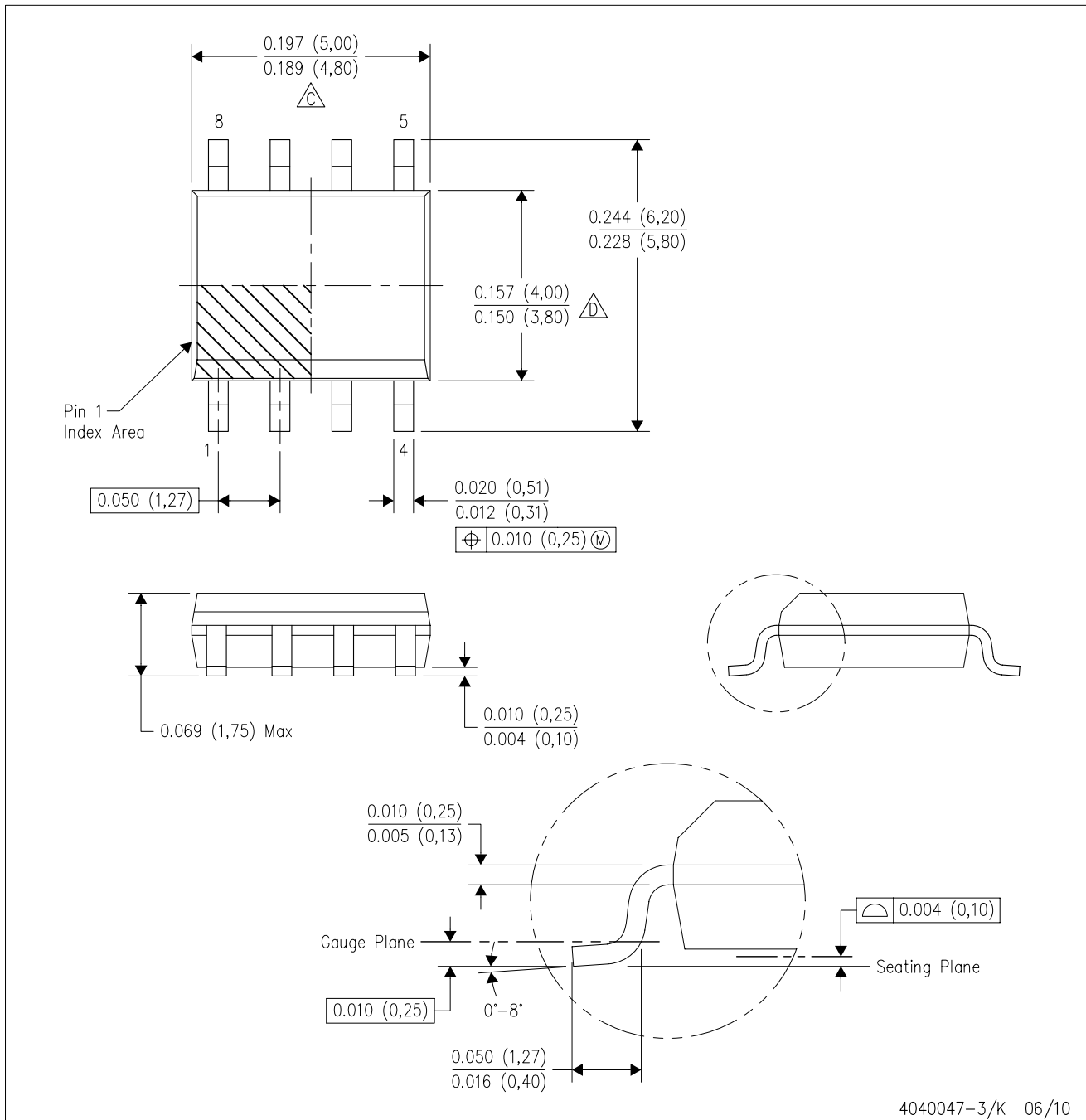
PLASTIC DUAL-IN-LINE PACKAGE



- NOTES:
- A. All linear dimensions are in inches (millimeters).
  - B. This drawing is subject to change without notice.
  - C. Falls within JEDEC MS-001 variation BA.

D (R-PDSO-G8)

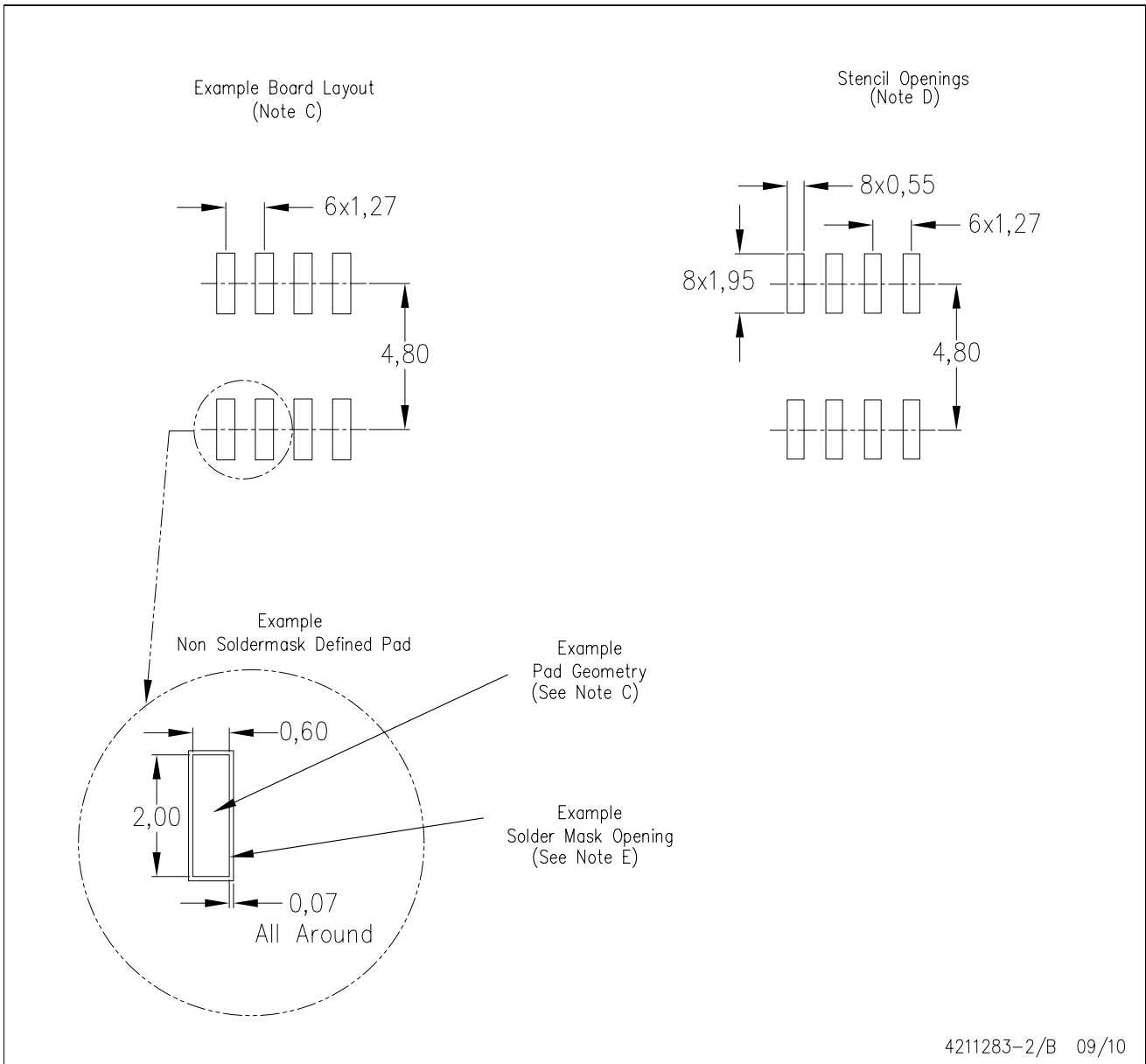
PLASTIC SMALL-OUTLINE PACKAGE



- NOTES:
- A. All linear dimensions are in inches (millimeters).
  - B. This drawing is subject to change without notice.
  - C. Body length does not include mold flash, protrusions, or gate burrs. Mold flash, protrusions, or gate burrs shall not exceed .006 (0,15) per end.
  - D. Body width does not include interlead flash. Interlead flash shall not exceed .017 (0,43) per side.
  - E. Reference JEDEC MS-012 variation AA.

D (R-PDSO-G8)

PLASTIC SMALL OUTLINE



- NOTES:
- All linear dimensions are in millimeters.
  - This drawing is subject to change without notice.
  - Publication IPC-7351 is recommended for alternate designs.
  - Laser cutting apertures with trapezoidal walls and also rounding corners will offer better paste release. Customers should contact their board assembly site for stencil design recommendations. Refer to IPC-7525 for other stencil recommendations.
  - Customers should contact their board fabrication site for solder mask tolerances between and around signal pads.

## IMPORTANT NOTICE

Texas Instruments Incorporated and its subsidiaries (TI) reserve the right to make corrections, modifications, enhancements, improvements, and other changes to its products and services at any time and to discontinue any product or service without notice. Customers should obtain the latest relevant information before placing orders and should verify that such information is current and complete. All products are sold subject to TI's terms and conditions of sale supplied at the time of order acknowledgment.

TI warrants performance of its hardware products to the specifications applicable at the time of sale in accordance with TI's standard warranty. Testing and other quality control techniques are used to the extent TI deems necessary to support this warranty. Except where mandated by government requirements, testing of all parameters of each product is not necessarily performed.

TI assumes no liability for applications assistance or customer product design. Customers are responsible for their products and applications using TI components. To minimize the risks associated with customer products and applications, customers should provide adequate design and operating safeguards.

TI does not warrant or represent that any license, either express or implied, is granted under any TI patent right, copyright, mask work right, or other TI intellectual property right relating to any combination, machine, or process in which TI products or services are used. Information published by TI regarding third-party products or services does not constitute a license from TI to use such products or services or a warranty or endorsement thereof. Use of such information may require a license from a third party under the patents or other intellectual property of the third party, or a license from TI under the patents or other intellectual property of TI.

Reproduction of TI information in TI data books or data sheets is permissible only if reproduction is without alteration and is accompanied by all associated warranties, conditions, limitations, and notices. Reproduction of this information with alteration is an unfair and deceptive business practice. TI is not responsible or liable for such altered documentation. Information of third parties may be subject to additional restrictions.

Resale of TI products or services with statements different from or beyond the parameters stated by TI for that product or service voids all express and any implied warranties for the associated TI product or service and is an unfair and deceptive business practice. TI is not responsible or liable for any such statements.

TI products are not authorized for use in safety-critical applications (such as life support) where a failure of the TI product would reasonably be expected to cause severe personal injury or death, unless officers of the parties have executed an agreement specifically governing such use. Buyers represent that they have all necessary expertise in the safety and regulatory ramifications of their applications, and acknowledge and agree that they are solely responsible for all legal, regulatory and safety-related requirements concerning their products and any use of TI products in such safety-critical applications, notwithstanding any applications-related information or support that may be provided by TI. Further, Buyers must fully indemnify TI and its representatives against any damages arising out of the use of TI products in such safety-critical applications.

TI products are neither designed nor intended for use in military/aerospace applications or environments unless the TI products are specifically designated by TI as military-grade or "enhanced plastic." Only products designated by TI as military-grade meet military specifications. Buyers acknowledge and agree that any such use of TI products which TI has not designated as military-grade is solely at the Buyer's risk, and that they are solely responsible for compliance with all legal and regulatory requirements in connection with such use.

TI products are neither designed nor intended for use in automotive applications or environments unless the specific TI products are designated by TI as compliant with ISO/TS 16949 requirements. Buyers acknowledge and agree that, if they use any non-designated products in automotive applications, TI will not be responsible for any failure to meet such requirements.

Following are URLs where you can obtain information on other Texas Instruments products and application solutions:

<b>Products</b>		<b>Applications</b>	
Amplifiers	<a href="http://amplifier.ti.com">amplifier.ti.com</a>	Audio	<a href="http://www.ti.com/audio">www.ti.com/audio</a>
Data Converters	<a href="http://dataconverter.ti.com">dataconverter.ti.com</a>	Automotive	<a href="http://www.ti.com/automotive">www.ti.com/automotive</a>
DLP® Products	<a href="http://www.dlp.com">www.dlp.com</a>	Communications and Telecom	<a href="http://www.ti.com/communications">www.ti.com/communications</a>
DSP	<a href="http://dsp.ti.com">dsp.ti.com</a>	Computers and Peripherals	<a href="http://www.ti.com/computers">www.ti.com/computers</a>
Clocks and Timers	<a href="http://www.ti.com/clocks">www.ti.com/clocks</a>	Consumer Electronics	<a href="http://www.ti.com/consumer-apps">www.ti.com/consumer-apps</a>
Interface	<a href="http://interface.ti.com">interface.ti.com</a>	Energy	<a href="http://www.ti.com/energy">www.ti.com/energy</a>
Logic	<a href="http://logic.ti.com">logic.ti.com</a>	Industrial	<a href="http://www.ti.com/industrial">www.ti.com/industrial</a>
Power Mgmt	<a href="http://power.ti.com">power.ti.com</a>	Medical	<a href="http://www.ti.com/medical">www.ti.com/medical</a>
Microcontrollers	<a href="http://microcontroller.ti.com">microcontroller.ti.com</a>	Security	<a href="http://www.ti.com/security">www.ti.com/security</a>
RFID	<a href="http://www.ti-rfid.com">www.ti-rfid.com</a>	Space, Avionics & Defense	<a href="http://www.ti.com/space-avionics-defense">www.ti.com/space-avionics-defense</a>
RF/IF and ZigBee® Solutions	<a href="http://www.ti.com/lprf">www.ti.com/lprf</a>	Video and Imaging	<a href="http://www.ti.com/video">www.ti.com/video</a>
		Wireless	<a href="http://www.ti.com/wireless-apps">www.ti.com/wireless-apps</a>

Mailing Address: Texas Instruments, Post Office Box 655303, Dallas, Texas 75265  
Copyright © 2010, Texas Instruments Incorporated