

REV.	DESCRIPTION	DATE
A	NEW DRAWING	4/7/2006

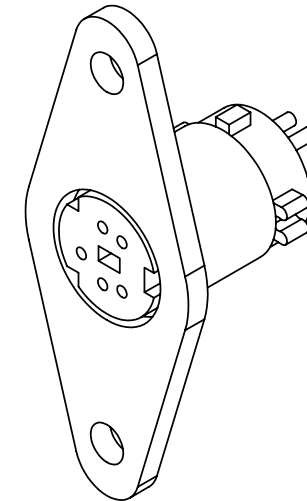

TOLERANCE:
X.X ±0.05mm

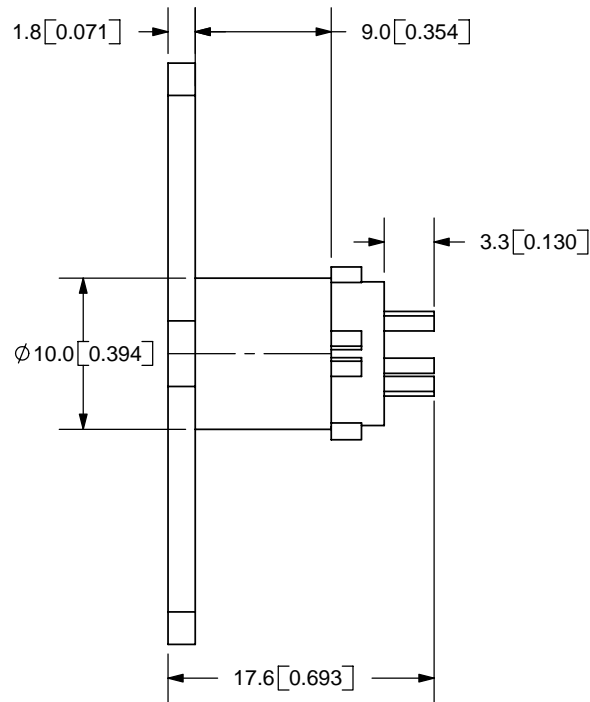
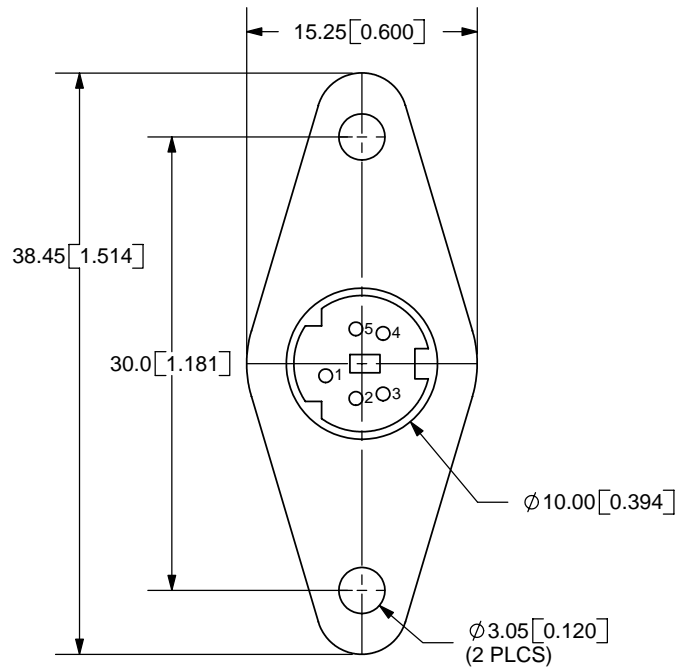

SPECIFICATIONS:
 RATING: 12V DC @ 2A
 CONTACT RESISTANCE: 30m OHMS MAX
 INSULATION RESISTANCE: 50M OHMS MIN: 250V DC
 VOLTAGE WITHSTAND: 250V AC R.M.S. FOR 1 MINUTE
 INSERTION FORCE: 4.5KG MAX
 WITHDRAWAL FORCE: 0.9KG~3.0KG
 LIFE: 5,000 CYCLES



20050 SW 112th Ave.
 Tualatin, OR 97062
 Phone: 503-643-4899
 800-275-4899
 Fax: 503-372-1266
 Website: www.cui.com

PC FILE NAME:
MD-50SN

COPYRIGHT 2006 BY CUI INC.

	MATERIAL	PLATING
SHELL	Steel	Nickel
CONTACTS	Phosphor Bronze	Silver
HOUSING	Fiber Nylon	

TITLE: PANEL MOUNT MINI DIN SOCKET		REV: A
PART NO. MD-50SN		UNITS: MM [INCHES]
DRAWN BY: ZRJ	APPROVED BY:	SCALE: 2:1