

- Ultra-Fast Operation . . . 10 ns (typ)
- Low Positive Supply Current  
12.7 mA (Typ)
- Operates From a Single 5-V Supply or From a Split  $\pm 5$ -V Supply
- Complementary Outputs
- Input Common-Mode Voltage Includes Negative Rail
- Low Offset Voltage
- No Minimum Slew Rate Requirement
- Output Latch Capability
- Functional Replacement to the LT1116

**D AND PW PACKAGE**  
(TOP VIEW)

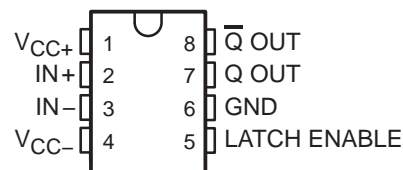

symbol (each comparator)

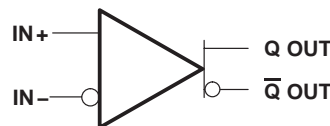

**description**

The TL3116 is an ultra-fast comparator designed to interface directly to TTL logic while operating from either a single 5-V power supply or dual  $\pm 5$ -V supplies. The input common-mode voltage extends to the negative rail for ground sensing applications. It features extremely tight offset voltage and high gain for precision applications. It has complementary outputs that can be latched using the LATCH ENABLE terminal. Figure 1 shows the positive supply current of the comparator. The TL3116 only requires 12.7 mA (typical) to achieve a propagation delay of 10 ns.

The TL3116 is a pin-for-pin functional replacement for the LT1116 comparator, offering high-speed operation but consuming much less power.

**POSITIVE SUPPLY CURRENT**  
vs  
**FREE-AIR TEMPERATURE**

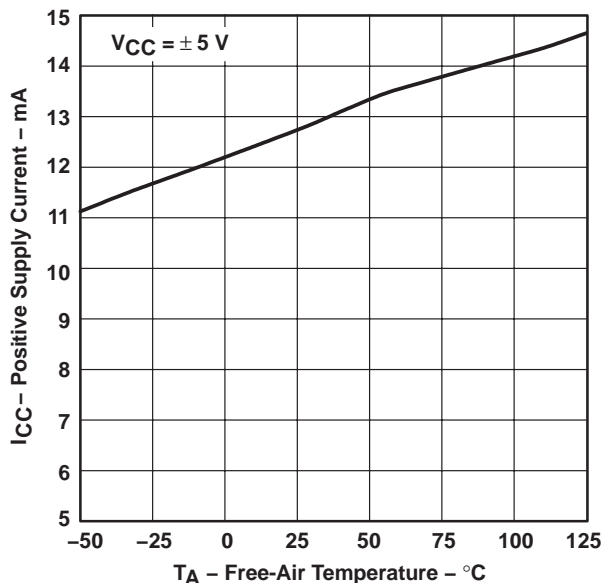

**Figure 1**

**AVAILABLE OPTIONS**

| T <sub>A</sub> | PACKAGED DEVICES               |             | CHIP FORM <sup>‡</sup> (Y) |
|----------------|--------------------------------|-------------|----------------------------|
|                | SMALL OUTLINE <sup>†</sup> (D) | TSSOP (PW)  |                            |
| 0°C to 70°C    | TL3116CD                       | TL3116CPWLE | TL3116Y                    |
| -40°C to 85°C  | TL3116ID                       | TL3116IPWLE | —                          |

<sup>†</sup> The PW packages are available left-ended taped and reeled only.

<sup>‡</sup> Chip forms are tested at T<sub>A</sub> = 25°C only.



Please be aware that an important notice concerning availability, standard warranty, and use in critical applications of Texas Instruments semiconductor products and disclaimers thereto appears at the end of this data sheet.

PRODUCTION DATA information is current as of publication date. Products conform to specifications per the terms of Texas Instruments standard warranty. Production processing does not necessarily include testing of all parameters.



# TL3116, TL3116Y ULTRA-FAST LOW-POWER PRECISION COMPARATORS

SLCS132C – MARCH 1997 – REVISED MAY 1997

## TL3116Y chip information

This chip, when properly assembled, displays characteristics similar to the TL3116C. Thermal compression or ultrasonic bonding may be used on the doped-aluminum bonding pads. Chips may be mounted with conductive epoxy or a gold-silicon preform.

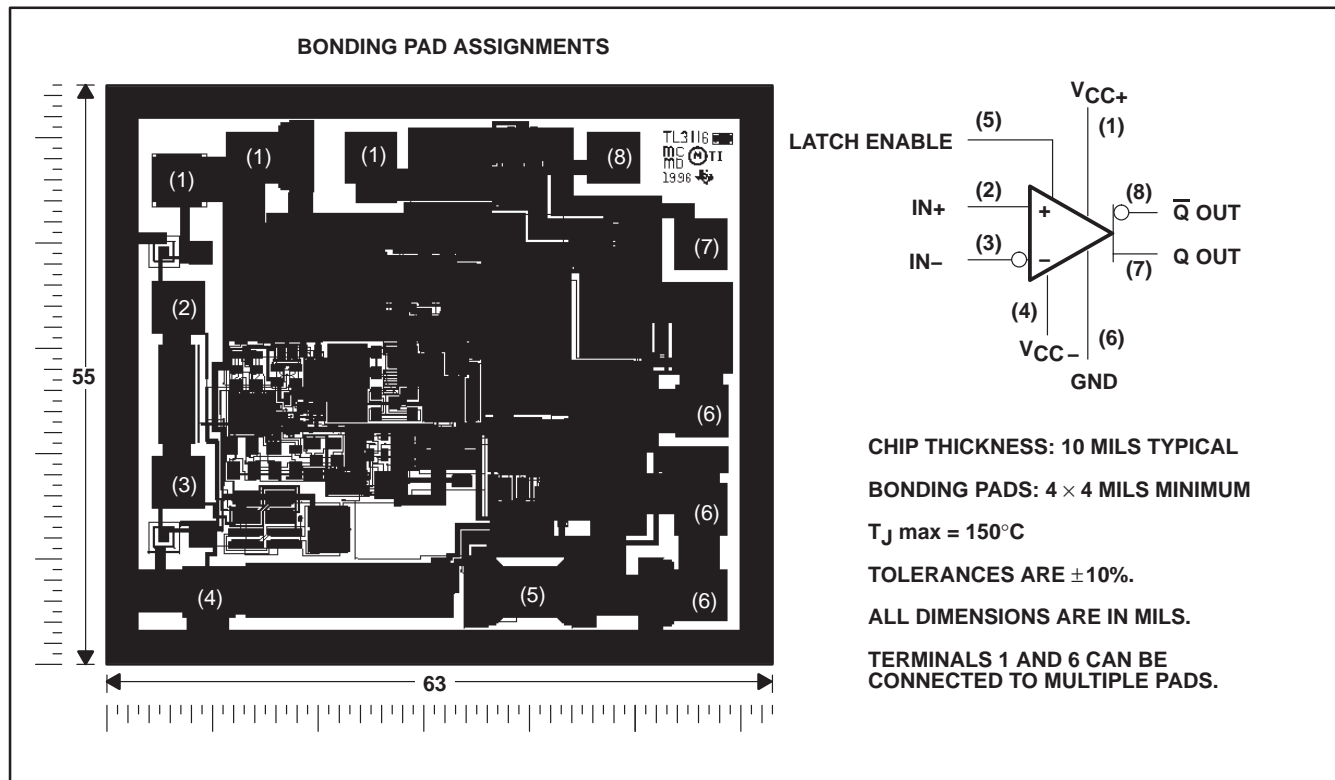

| COMPONENT COUNT |    |
|-----------------|----|
| Bipolars        | 53 |
| MOSFETs         | 49 |
| Resistors       | 46 |
| Capacitors      | 14 |

**absolute maximum ratings over operating free-air temperature range (unless otherwise noted)†**

|  |                              |
|--|------------------------------|
| Supply voltage, $V_{DD}$ (see Note 1)                        | – 7 V to 7 V                 |
| Differential input voltage, $V_{ID}$ (see Note 2)            | 7 V                          |
| Input voltage range, $V_I$                                   | 7 V                          |
| Input voltage, $V_I$ (LATCH ENABLE)                          | 7 V                          |
| Output current, $I_O$  | $\pm 20$ mA                  |
| Continuous total power dissipation                           | See Dissipation Rating Table |
| Operating free-air temperature range, $T_A$                  | –40°C to 85°C                |
| Storage temperature range, $T_{stg}$                         | – 65°C to 150°C              |
| Lead temperature 1,6 mm (1/16 inch) from case for 10 seconds | 260°C                        |

† Stresses beyond those listed under “absolute maximum ratings” may cause permanent damage to the device. These are stress ratings only, and functional operation of the device at these or any other conditions beyond those indicated under “recommended operating conditions” is not implied. Exposure to absolute-maximum-rated conditions for extended periods may affect device reliability.

- NOTES: 1. All voltage values, except differential voltages, are with respect to network ground.  
 2. Differential voltages are at IN+ with respect to IN–.

**DISSIPATION RATING TABLE**

| PACKAGE | $T_A \leq 25^\circ\text{C}$<br>POWER RATING | DERATING FACTOR<br>ABOVE $T_A = 25^\circ\text{C}$ | $T_A = 70^\circ\text{C}$<br>POWER RATING |
|---------|---|---|--|
| D       | 725 mW                                      | 5.8 mW/°C   | 464 mW                                   |
| PW      | 525 mW                                      | 4.2 mW/°C   | 336 mW                                   |

# TL3116, TL3116Y

## ULTRA-FAST LOW-POWER PRECISION COMPARATORS

SLCS132C – MARCH 1997 – REVISED MAY 1997

electrical characteristics at specified operating free-air temperature,  $V_{DD} = \pm 5\text{ V}$ ,  $V_{LE} = 0$  (unless otherwise noted)

| PARAMETER      |   | TEST CONDITION†   | TL3116C |      |      | TL3116I |      |                              | UNIT          |
|----------------|---|---|---------|------|------|---------|------|------------------------------|---------------|
|                |   |   | MIN     | TYP‡ | MAX  | MIN     | TYP‡ | MAX                          |               |
| $V_{IO}$       | Input offset voltage                            | $T_A = 25^\circ\text{C}$  |         | 0.5  | 3    |         | 0.5  | 3                            | mV            |
|                |   | $T_A = \text{full range}$   |         |      | 3.5  |         |      | 3.5                          |               |
| $\alpha_{VIO}$ | Temperature coefficient of input offset voltage |   |         | -2.5 |      |         | -2.8 | $\mu\text{V}/^\circ\text{C}$ |               |
| $I_{IO}$       | Input offset current                            | $T_A = 25^\circ\text{C}$  |         | 0.1  | 0.2  |         | 0.1  | 0.2                          | $\mu\text{A}$ |
|                |   | $T_A = \text{full range}$   |         |      | 0.3  |         |      | 0.35                         |               |
| $I_{IB}$       | Input bias current                              | $T_A = 25^\circ\text{C}$  |         | 0.7  | 1.1  |         | 0.7  | 1.1                          | $\mu\text{A}$ |
|                |   | $T_A = \text{full range}$   |         |      | 1.2  |         |      | 1.5                          |               |
| $V_{ICR}$      | Common-mode input voltage range                 | $V_{DD} = \pm 5\text{ V}$   | -5      |      | 2.5  | -5      |      | 2.5                          | V             |
|                |   | $V_{DD} = 5\text{ V}$   | 0       |      | 2.5  | 0       |      | 2.5                          |               |
| CMRR           | Common-mode rejection ratio                     | $-5 \leq V_{IC} \leq 2.5\text{ V}$  | 75      | 100  |      | 75      | 100  | dB                           |               |
| $k_{SVR}$      | Supply-voltage rejection ratio                  | Positive supply: $4.6\text{ V} \leq +V_{DD} \leq 5.4\text{ V}$ ,<br>$T_A = 25^\circ\text{C}$  | 60      | 80   |      | 60      | 80   | dB                           |               |
|                |   | Negative supply: $-7\text{ V} \leq -V_{DD} \leq -2\text{ V}$ ,<br>$T_A = 25^\circ\text{C}$    | 80      | 100  |      | 80      | 100  |                              |               |
| $V_{OL}$       | Low-level output voltage                        | $I_{(\text{sink})} = 4\text{ mA}$ ,<br>$T_A = 25^\circ\text{C}$ ,<br>$V_+ \leq 4.6\text{ V}$  |         | 400  | 600  |         | 400  | 600                          | mV            |
|                |   | $I_{(\text{sink})} = 10\text{ mA}$ ,<br>$T_A = 25^\circ\text{C}$ ,<br>$V_+ \leq 4.6\text{ V}$ |         | 750  |      |         | 750  |                              |               |
| $V_{OH}$       | High-level output voltage                       | $V_+ \leq 4.6\text{ V}$ ,<br>$T_A = 25^\circ\text{C}$ ,<br>$I_O = 1\text{ mA}$                | 3.6     | 3.9  |      | 3.6     | 3.9  | V                            |               |
|                |   | $V_+ \leq 4.6\text{ V}$ ,<br>$T_A = 25^\circ\text{C}$ ,<br>$I_O = 10\text{ mA}$               | 3.4     | 3.8  |      | 3.4     | 3.8  |                              |               |
| $I_{CC}$       | Positive supply current                         | $T_A = \text{full range}$   |         | 12.7 | 14.7 |         | 12.7 | 15                           | mA            |
|                | Negative supply current                         |   |         | -2.6 |      |         | -3   |                              |               |
| $V_{IL}$       | Low-level input voltage (LATCH ENABLE)          |   |         | 0.8  |      |         | 0.8  | V                            |               |
| $V_{IH}$       | High-level input voltage (LATCH ENABLE)         |   | 2       |      |      | 2       |      | V                            |               |
| $I_{IL}$       | Low-level input current (LATCH ENABLE)          | $V_{LE} = 0$  |         | 0    | 1    |         | 0    | 1                            | $\mu\text{A}$ |
|                |   | $V_{LE} = 2\text{ V}$   |         | 24   | 39   |         | 24   | 45                           | $\mu\text{A}$ |

† Full range for the TL3116C is  $T_A = 0^\circ\text{C}$  to  $70^\circ\text{C}$ . Full range for the TL3116I is  $T_A = -40^\circ\text{C}$  to  $85^\circ\text{C}$ .

‡ All typical values are measures with  $T_A = 25^\circ\text{C}$ .



**switching characteristics,  $V_{DD} = \pm 5\text{ V}$ ,  $V_{LE} = 0$**

| PARAMETER                                      | TEST CONDITION†  |                           | TL3116C |      |     | TL3116I |      |     | UNIT |
|--|--|---------------------------|---------|------|-----|---------|------|-----|------|
|  |  |                           | MIN     | TYP  | MAX | MIN     | TYP  | MAX |      |
| $t_{pd1}$ Propagation delay time‡              | $\Delta V_I = 100\text{ mV}$ ,<br>$V_{OD} = 5\text{ mV}$   | $T_A = 25^\circ\text{C}$  | 9.9     | 12   |     | 9.9     | 12   | ns  |      |
|  |  | $T_A = \text{full range}$ | 9.9     | 14   |     | 9.9     | 15   |     |      |
|  | $\Delta V_I = 100\text{ mV}$ ,<br>$V_{OD} = 20\text{ mV}$  | $T_A = 25^\circ\text{C}$  | 8.2     | 10.3 |     | 8.2     | 10.3 |     |      |
|  |  | $T_A = \text{full range}$ | 8.2     | 12.7 |     | 8.2     | 13.7 |     |      |
| $t_{sk(p)}$ Pulse skew ( $t_{pd+} - t_{pd-}$ ) | $\Delta V_I = 100\text{ mV}$ ,<br>$T_A = 25^\circ\text{C}$ | $V_{OD} = 5\text{ mV}$    | 0.5     |      |     | 0.5     | ns   |     |      |
| $t_{su}$ Setup time, LATCH ENABLE              |  |                           | 3.4     |      |     | 3.4     | ns   |     |      |

† Full range for the TL3116C is  $0^\circ\text{C}$  to  $70^\circ\text{C}$ . Full range for the TL3116I is  $-40^\circ\text{C}$  to  $85^\circ\text{C}$ .

‡  $t_{pd1}$  cannot be measured in automatic handling equipment with low values of overdrive. The TL3116 is 100% tested with a 1-V step and 500-mV overdrive at  $T_A = 25^\circ\text{C}$  only. Correlation tests have shown that  $t_{pd1}$  limits given can be ensured with this test, if additional dc tests are performed to ensure that all internal bias conditions are correct. For low overdrive conditions,  $V_{OS}$  is added to the overdrive.

**TYPICAL CHARACTERISTICS**

**Table of Graphs**

|          |  | FIGURE                   |    |
|----------|--|--------------------------|----|
| $I_{CC}$ | Positive supply current                | vs Input voltage         | 2  |
|          |  | vs Frequency             | 3  |
|          |  | vs Free-air temperature  | 4  |
| $I_{CC}$ | Negative supply current                | vs Free-air temperature  | 5  |
| $t_{pd}$ | Propagation delay time                 | vs Overdrive voltage     | 6  |
|          |  | vs Supply voltage        | 7  |
|          |  | vs Input impedance       | 8  |
|          |  | vs Load capacitance      | 9  |
|          |  | vs Free-air temperature  | 10 |
| $V_{IC}$ | Common-mode input voltage              | vs Free-air temperature  | 11 |
| $V_{IT}$ | Input threshold voltage (LATCH ENABLE) | vs Free-air temperature  | 12 |
| $V_O$    | Output voltage                         | vs Output source current | 13 |
|          |  | vs Output sink current   | 14 |
| $I_I$    | Input current (LATCH ENABLE)           | vs Input voltage         | 15 |

**TYPICAL CHARACTERISTICS**

**POSITIVE SUPPLY CURRENT  
 vs  
 INPUT VOLTAGE**

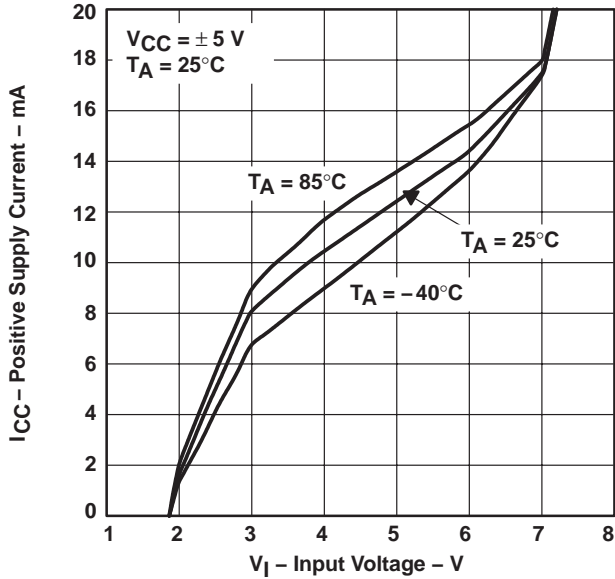

**Figure 2**

**POSITIVE SUPPLY CURRENT  
 vs  
 FREQUENCY**

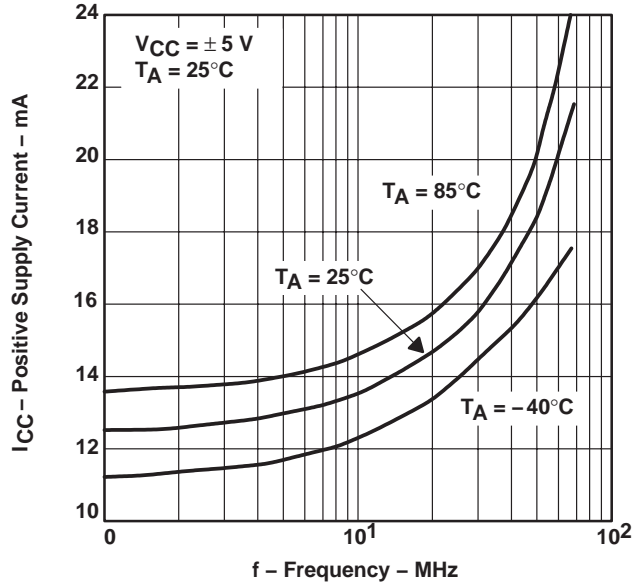

**Figure 3**

**POSITIVE SUPPLY CURRENT  
 vs  
 FREE-AIR TEMPERATURE**

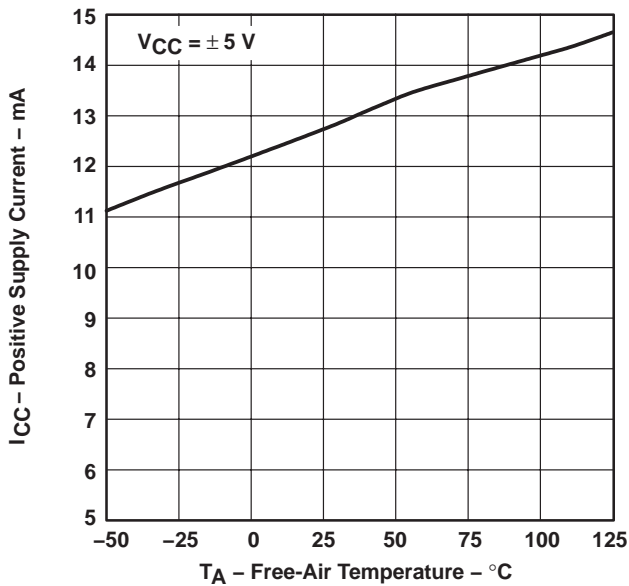

**Figure 4**

**NEGATIVE SUPPLY CURRENT  
 vs  
 FREE-AIR TEMPERATURE**

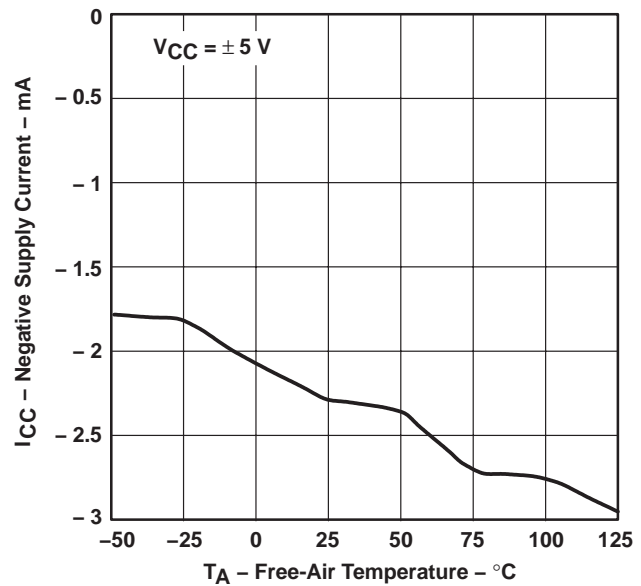

**Figure 5**

TYPICAL CHARACTERISTICS

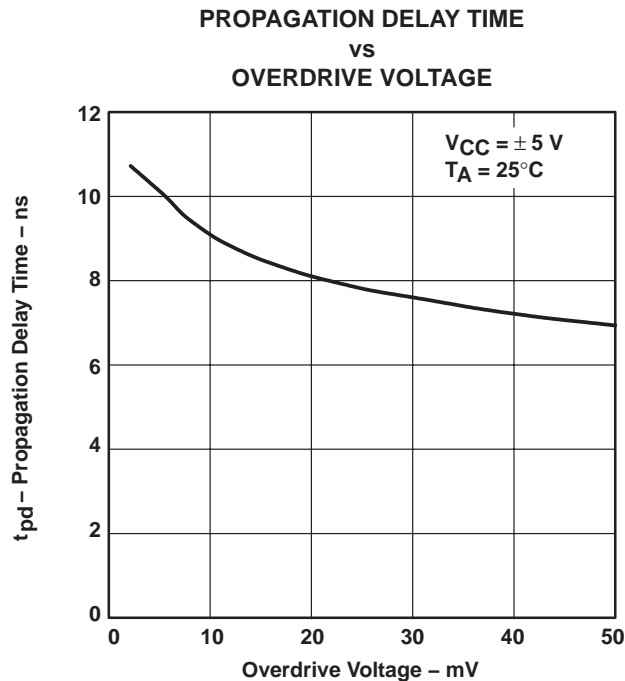

Figure 6

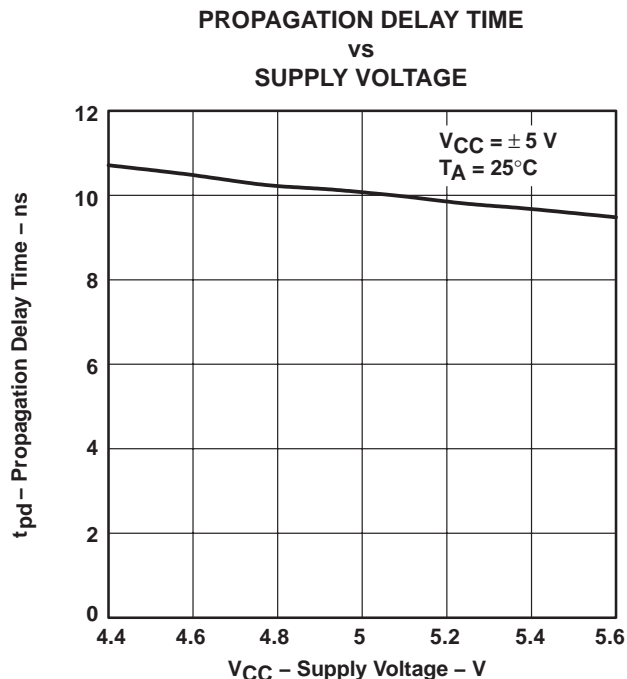

Figure 7

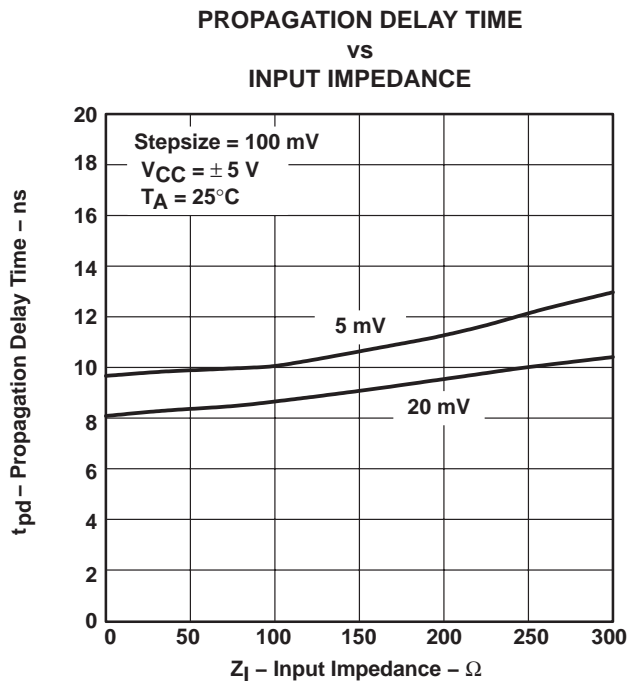

Figure 8

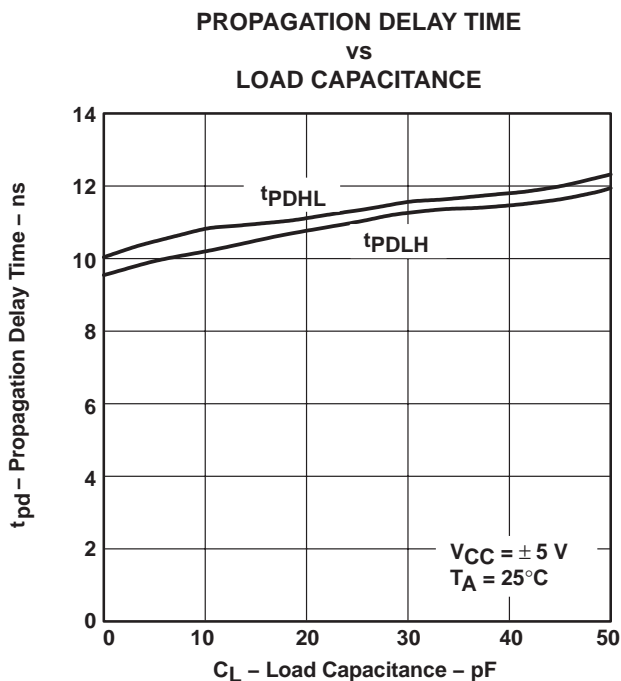
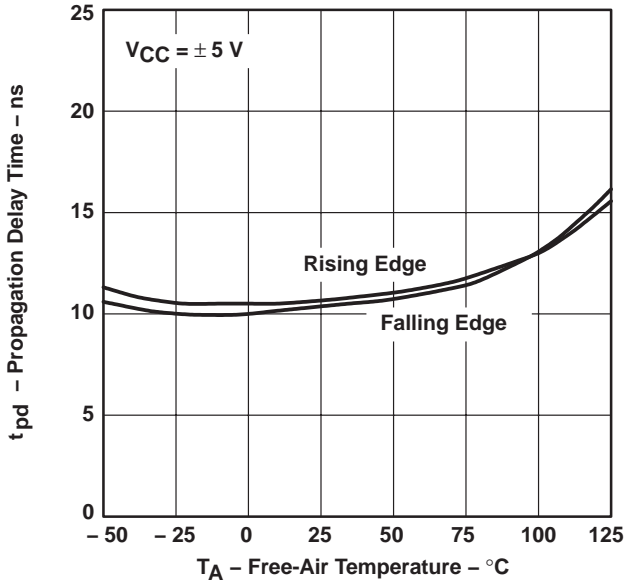

Figure 9

**TYPICAL CHARACTERISTICS**

**PROPAGATION DELAY TIME**  
**vs**  
**FREE-AIR TEMPERATURE**



**Figure 10**

**COMMON-MODE INPUT VOLTAGE**  
**vs**  
**FREE-AIR TEMPERATURE**

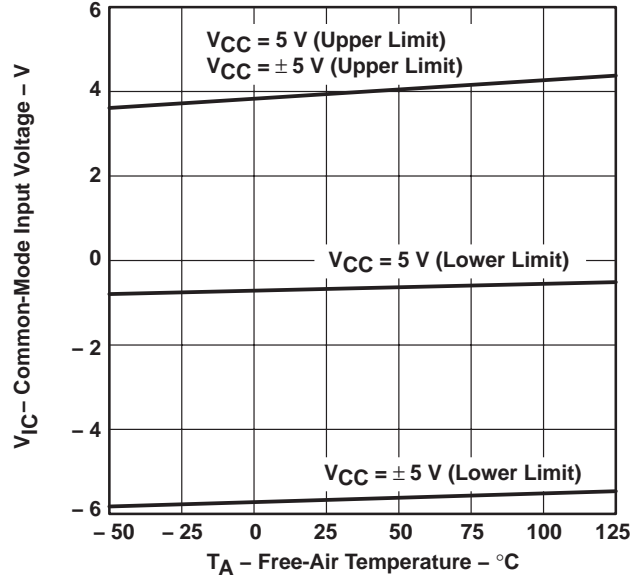

**Figure 11**

**INPUT THRESHOLD VOLTAGE (LATCH ENABLE)**  
**vs**  
**FREE-AIR TEMPERATURE**

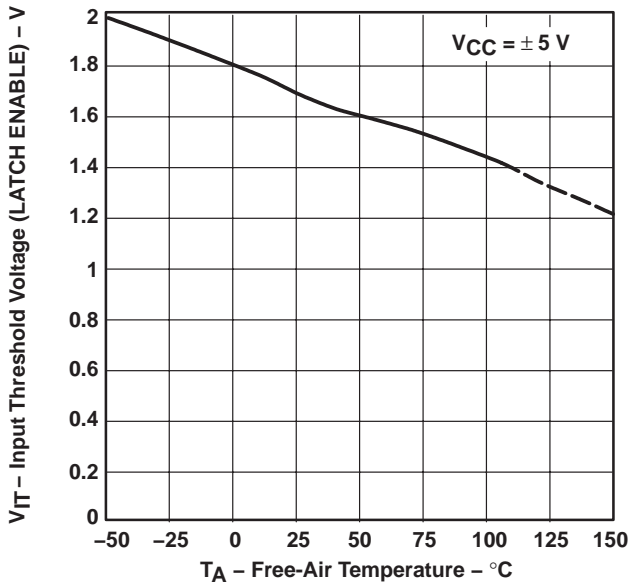

**Figure 12**

**OUTPUT VOLTAGE**  
**vs**  
**OUTPUT SOURCE CURRENT**

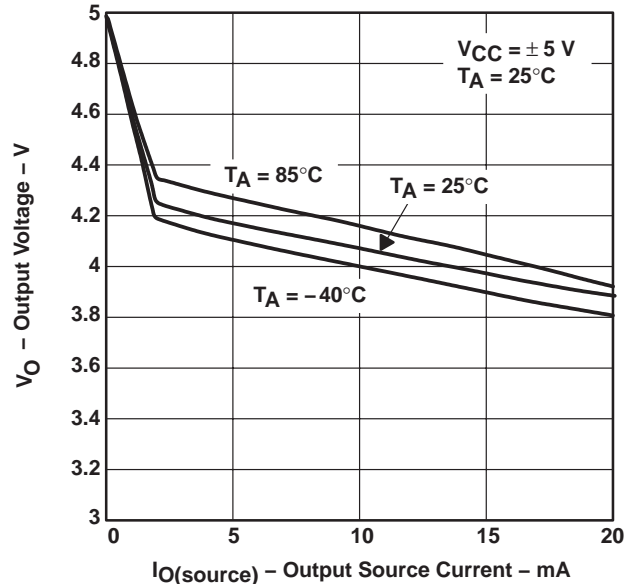

**Figure 13**



TYPICAL CHARACTERISTICS

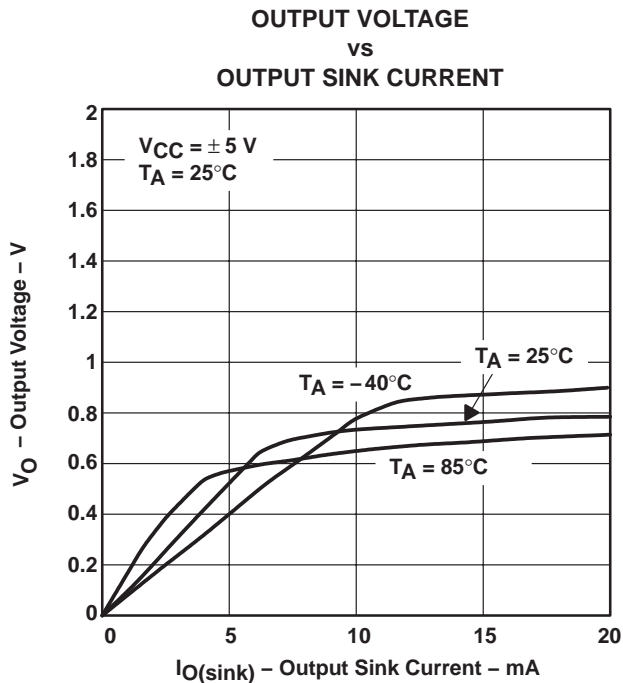

Figure 14

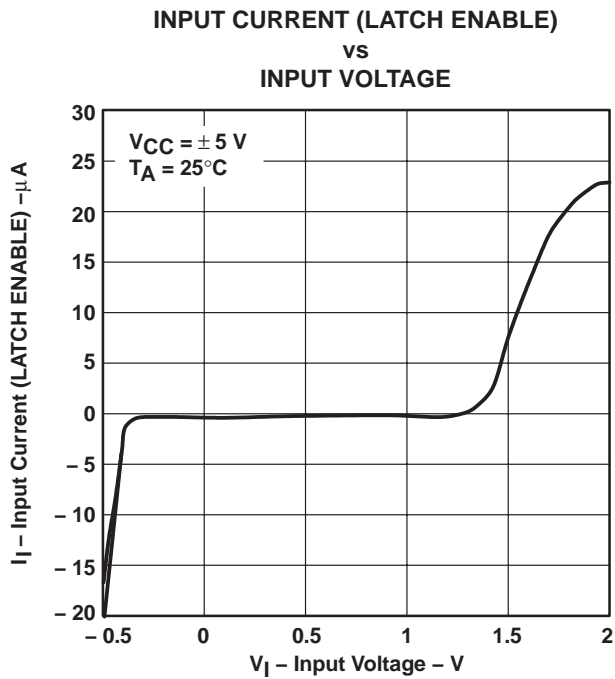

Figure 15

**PACKAGING INFORMATION**

| Orderable Device | Status <sup>(1)</sup> | Package Type | Package Drawing | Pins | Package Qty | Eco Plan <sup>(2)</sup> | Lead/Ball Finish | MSL Peak Temp <sup>(3)</sup> |
|------------------|-----------------------|--------------|-----------------|------|-------------|-------------------------|------------------|------------------------------|
| TL3116CD         | ACTIVE                | SOIC         | D               | 8    | 75          | Green (RoHS & no Sb/Br) | CU NIPDAU        | Level-1-260C-UNLIM           |
| TL3116CDG4       | ACTIVE                | SOIC         | D               | 8    | 75          | Green (RoHS & no Sb/Br) | CU NIPDAU        | Level-1-260C-UNLIM           |
| TL3116CDR        | ACTIVE                | SOIC         | D               | 8    | 2500        | Green (RoHS & no Sb/Br) | CU NIPDAU        | Level-1-260C-UNLIM           |
| TL3116CDRG4      | ACTIVE                | SOIC         | D               | 8    | 2500        | Green (RoHS & no Sb/Br) | CU NIPDAU        | Level-1-260C-UNLIM           |
| TL3116CPW        | ACTIVE                | TSSOP        | PW              | 8    | 150         | Green (RoHS & no Sb/Br) | CU NIPDAU        | Level-1-260C-UNLIM           |
| TL3116CPWG4      | ACTIVE                | TSSOP        | PW              | 8    | 150         | Green (RoHS & no Sb/Br) | CU NIPDAU        | Level-1-260C-UNLIM           |
| TL3116CPWLE      | OBSOLETE              | TSSOP        | PW              | 8    |             | TBD                     | Call TI          | Call TI                      |
| TL3116CPWR       | ACTIVE                | TSSOP        | PW              | 8    | 2000        | Green (RoHS & no Sb/Br) | CU NIPDAU        | Level-1-260C-UNLIM           |
| TL3116CPWRG4     | ACTIVE                | TSSOP        | PW              | 8    | 2000        | Green (RoHS & no Sb/Br) | CU NIPDAU        | Level-1-260C-UNLIM           |
| TL3116ID         | ACTIVE                | SOIC         | D               | 8    | 75          | Green (RoHS & no Sb/Br) | CU NIPDAU        | Level-1-260C-UNLIM           |
| TL3116IDG4       | ACTIVE                | SOIC         | D               | 8    | 75          | Green (RoHS & no Sb/Br) | CU NIPDAU        | Level-1-260C-UNLIM           |
| TL3116IDR        | ACTIVE                | SOIC         | D               | 8    | 2500        | Green (RoHS & no Sb/Br) | CU NIPDAU        | Level-1-260C-UNLIM           |
| TL3116IDRG4      | ACTIVE                | SOIC         | D               | 8    | 2500        | Green (RoHS & no Sb/Br) | CU NIPDAU        | Level-1-260C-UNLIM           |
| TL3116IPW        | ACTIVE                | TSSOP        | PW              | 8    | 150         | Green (RoHS & no Sb/Br) | CU NIPDAU        | Level-1-260C-UNLIM           |
| TL3116IPWG4      | ACTIVE                | TSSOP        | PW              | 8    | 150         | Green (RoHS & no Sb/Br) | CU NIPDAU        | Level-1-260C-UNLIM           |
| TL3116IPWLE      | OBSOLETE              | TSSOP        | PW              | 8    |             | TBD                     | Call TI          | Call TI                      |
| TL3116IPWR       | ACTIVE                | TSSOP        | PW              | 8    | 2000        | Green (RoHS & no Sb/Br) | CU NIPDAU        | Level-1-260C-UNLIM           |
| TL3116IPWRG4     | ACTIVE                | TSSOP        | PW              | 8    | 2000        | Green (RoHS & no Sb/Br) | CU NIPDAU        | Level-1-260C-UNLIM           |

<sup>(1)</sup> The marketing status values are defined as follows:

**ACTIVE:** Product device recommended for new designs.

**LIFEBUY:** TI has announced that the device will be discontinued, and a lifetime-buy period is in effect.

**NRND:** Not recommended for new designs. Device is in production to support existing customers, but TI does not recommend using this part in a new design.

**PREVIEW:** Device has been announced but is not in production. Samples may or may not be available.

**OBSOLETE:** TI has discontinued the production of the device.

<sup>(2)</sup> Eco Plan - The planned eco-friendly classification: Pb-Free (RoHS), Pb-Free (RoHS Exempt), or Green (RoHS & no Sb/Br) - please check <http://www.ti.com/productcontent> for the latest availability information and additional product content details.

**TBD:** The Pb-Free/Green conversion plan has not been defined.

**Pb-Free (RoHS):** TI's terms "Lead-Free" or "Pb-Free" mean semiconductor products that are compatible with the current RoHS requirements for all 6 substances, including the requirement that lead not exceed 0.1% by weight in homogeneous materials. Where designed to be soldered at high temperatures, TI Pb-Free products are suitable for use in specified lead-free processes.

**Pb-Free (RoHS Exempt):** This component has a RoHS exemption for either 1) lead-based flip-chip solder bumps used between the die and package, or 2) lead-based die adhesive used between the die and leadframe. The component is otherwise considered Pb-Free (RoHS compatible) as defined above.

**Green (RoHS & no Sb/Br):** TI defines "Green" to mean Pb-Free (RoHS compatible), and free of Bromine (Br) and Antimony (Sb) based flame retardants (Br or Sb do not exceed 0.1% by weight in homogeneous material)

<sup>(3)</sup> MSL, Peak Temp. -- The Moisture Sensitivity Level rating according to the JEDEC industry standard classifications, and peak solder temperature.

**Important Information and Disclaimer:**The information provided on this page represents TI's knowledge and belief as of the date that it is provided. TI bases its knowledge and belief on information provided by third parties, and makes no representation or warranty as to the accuracy of such information. Efforts are underway to better integrate information from third parties. TI has taken and continues to take reasonable steps to provide representative and accurate information but may not have conducted destructive testing or chemical analysis on incoming materials and chemicals. TI and TI suppliers consider certain information to be proprietary, and thus CAS numbers and other limited information may not be available for release.

In no event shall TI's liability arising out of such information exceed the total purchase price of the TI part(s) at issue in this document sold by TI to Customer on an annual basis.

**TAPE AND REEL INFORMATION**

**QUADRANT ASSIGNMENTS FOR PIN 1 ORIENTATION IN TAPE**

\*All dimensions are nominal

| Device     | Package Type | Package Drawing | Pins | SPQ  | Reel Diameter (mm) | Reel Width W1 (mm) | A0 (mm) | B0 (mm) | K0 (mm) | P1 (mm) | W (mm) | Pin1 Quadrant |
|------------|--------------|-----------------|------|------|--------------------|--------------------|---------|---------|---------|---------|--------|---------------|
| TL3116CDR  | SOIC         | D               | 8    | 2500 | 330.0              | 12.4               | 6.4     | 5.2     | 2.1     | 8.0     | 12.0   | Q1            |
| TL3116CPWR | TSSOP        | PW              | 8    | 2000 | 330.0              | 12.4               | 7.0     | 3.6     | 1.6     | 8.0     | 12.0   | Q1            |
| TL3116IDR  | SOIC         | D               | 8    | 2500 | 330.0              | 12.4               | 6.4     | 5.2     | 2.1     | 8.0     | 12.0   | Q1            |
| TL3116IPWR | TSSOP        | PW              | 8    | 2000 | 330.0              | 12.4               | 7.0     | 3.6     | 1.6     | 8.0     | 12.0   | Q1            |

**TAPE AND REEL BOX DIMENSIONS**

\*All dimensions are nominal

| Device     | Package Type | Package Drawing | Pins | SPQ  | Length (mm) | Width (mm) | Height (mm) |
|------------|--------------|-----------------|------|------|-------------|------------|-------------|
| TL3116CDR  | SOIC         | D               | 8    | 2500 | 346.0       | 346.0      | 29.0        |
| TL3116CPWR | TSSOP        | PW              | 8    | 2000 | 346.0       | 346.0      | 29.0        |
| TL3116IDR  | SOIC         | D               | 8    | 2500 | 346.0       | 346.0      | 29.0        |
| TL3116IPWR | TSSOP        | PW              | 8    | 2000 | 346.0       | 346.0      | 29.0        |

D (R-PDSO-G8)

PLASTIC SMALL-OUTLINE PACKAGE

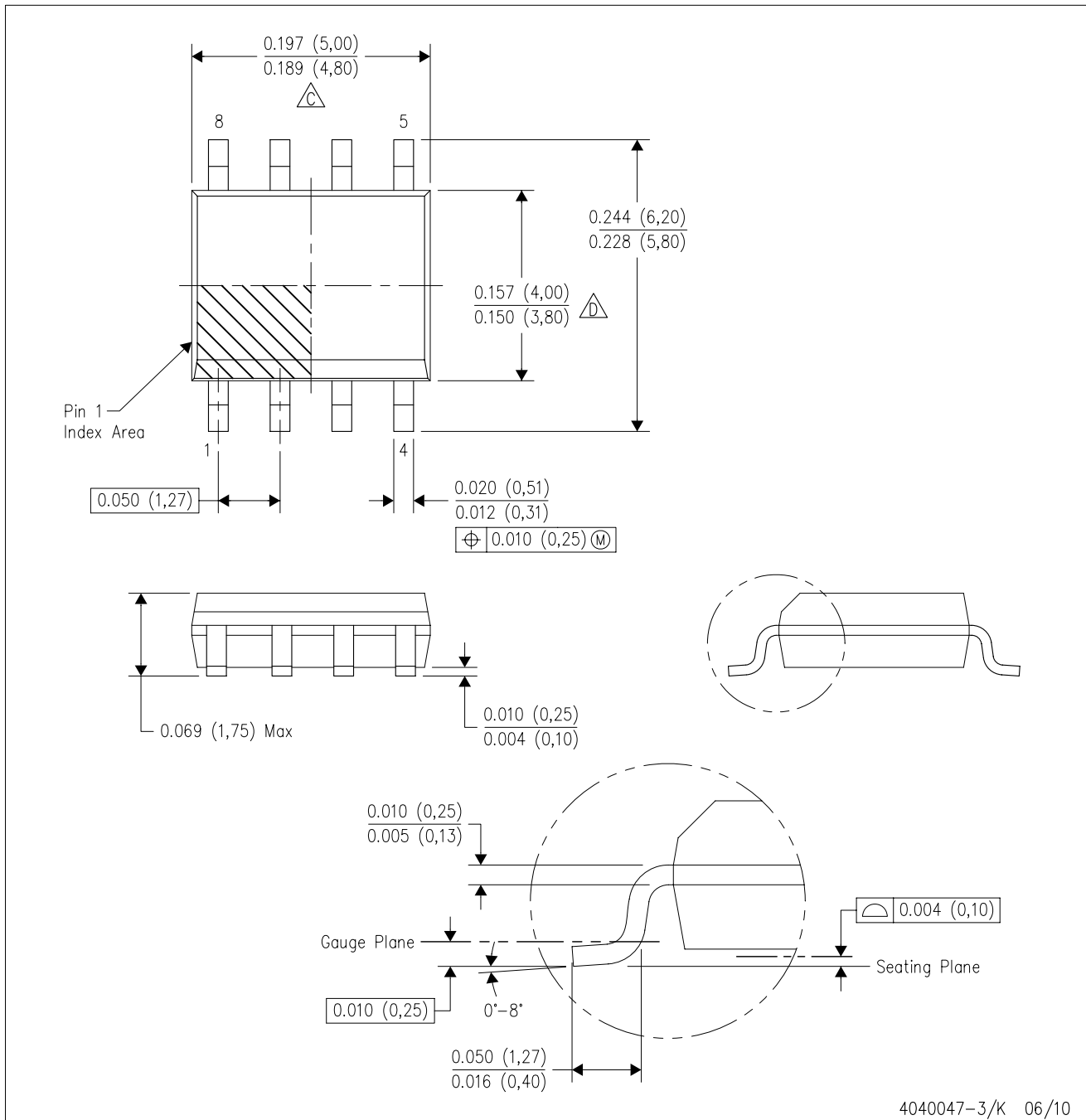

- NOTES:
- A. All linear dimensions are in inches (millimeters).
  - B. This drawing is subject to change without notice.
  - C. Body length does not include mold flash, protrusions, or gate burrs. Mold flash, protrusions, or gate burrs shall not exceed .006 (0,15) per end.
  - D. Body width does not include interlead flash. Interlead flash shall not exceed .017 (0,43) per side.
  - E. Reference JEDEC MS-012 variation AA.

D (R-PDSO-G8)

PLASTIC SMALL OUTLINE

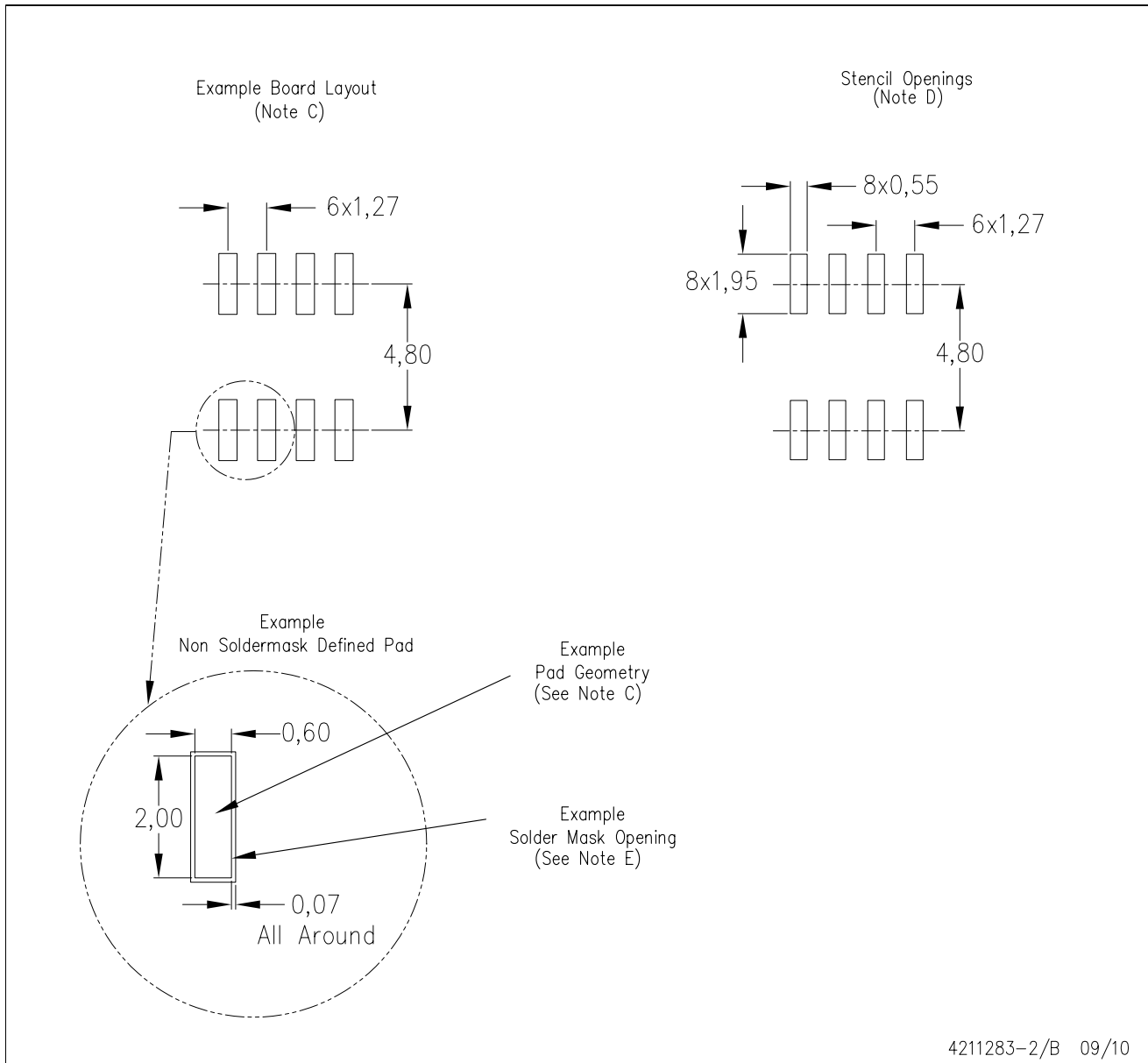

- NOTES:
- All linear dimensions are in millimeters.
  - This drawing is subject to change without notice.
  - Publication IPC-7351 is recommended for alternate designs.
  - Laser cutting apertures with trapezoidal walls and also rounding corners will offer better paste release. Customers should contact their board assembly site for stencil design recommendations. Refer to IPC-7525 for other stencil recommendations.
  - Customers should contact their board fabrication site for solder mask tolerances between and around signal pads.

PW (R-PDSO-G\*\*)

PLASTIC SMALL-OUTLINE PACKAGE

14 PINS SHOWN



4040064/F 01/97

- NOTES: A. All linear dimensions are in millimeters.  
 B. This drawing is subject to change without notice.  
 C. Body dimensions do not include mold flash or protrusion not to exceed 0,15.  
 D. Falls within JEDEC MO-153



## IMPORTANT NOTICE

Texas Instruments Incorporated and its subsidiaries (TI) reserve the right to make corrections, modifications, enhancements, improvements, and other changes to its products and services at any time and to discontinue any product or service without notice. Customers should obtain the latest relevant information before placing orders and should verify that such information is current and complete. All products are sold subject to TI's terms and conditions of sale supplied at the time of order acknowledgment.

TI warrants performance of its hardware products to the specifications applicable at the time of sale in accordance with TI's standard warranty. Testing and other quality control techniques are used to the extent TI deems necessary to support this warranty. Except where mandated by government requirements, testing of all parameters of each product is not necessarily performed.

TI assumes no liability for applications assistance or customer product design. Customers are responsible for their products and applications using TI components. To minimize the risks associated with customer products and applications, customers should provide adequate design and operating safeguards.

TI does not warrant or represent that any license, either express or implied, is granted under any TI patent right, copyright, mask work right, or other TI intellectual property right relating to any combination, machine, or process in which TI products or services are used. Information published by TI regarding third-party products or services does not constitute a license from TI to use such products or services or a warranty or endorsement thereof. Use of such information may require a license from a third party under the patents or other intellectual property of the third party, or a license from TI under the patents or other intellectual property of TI.

Reproduction of TI information in TI data books or data sheets is permissible only if reproduction is without alteration and is accompanied by all associated warranties, conditions, limitations, and notices. Reproduction of this information with alteration is an unfair and deceptive business practice. TI is not responsible or liable for such altered documentation. Information of third parties may be subject to additional restrictions.

Resale of TI products or services with statements different from or beyond the parameters stated by TI for that product or service voids all express and any implied warranties for the associated TI product or service and is an unfair and deceptive business practice. TI is not responsible or liable for any such statements.

TI products are not authorized for use in safety-critical applications (such as life support) where a failure of the TI product would reasonably be expected to cause severe personal injury or death, unless officers of the parties have executed an agreement specifically governing such use. Buyers represent that they have all necessary expertise in the safety and regulatory ramifications of their applications, and acknowledge and agree that they are solely responsible for all legal, regulatory and safety-related requirements concerning their products and any use of TI products in such safety-critical applications, notwithstanding any applications-related information or support that may be provided by TI. Further, Buyers must fully indemnify TI and its representatives against any damages arising out of the use of TI products in such safety-critical applications.

TI products are neither designed nor intended for use in military/aerospace applications or environments unless the TI products are specifically designated by TI as military-grade or "enhanced plastic." Only products designated by TI as military-grade meet military specifications. Buyers acknowledge and agree that any such use of TI products which TI has not designated as military-grade is solely at the Buyer's risk, and that they are solely responsible for compliance with all legal and regulatory requirements in connection with such use.

TI products are neither designed nor intended for use in automotive applications or environments unless the specific TI products are designated by TI as compliant with ISO/TS 16949 requirements. Buyers acknowledge and agree that, if they use any non-designated products in automotive applications, TI will not be responsible for any failure to meet such requirements.

Following are URLs where you can obtain information on other Texas Instruments products and application solutions:

| <b>Products</b>             |  | <b>Applications</b>        |  |
|-----------------------------|--|----------------------------|--|
| Amplifiers                  | <a href="http://amplifier.ti.com">amplifier.ti.com</a>             | Audio                      | <a href="http://www.ti.com/audio">www.ti.com/audio</a>                                   |
| Data Converters             | <a href="http://dataconverter.ti.com">dataconverter.ti.com</a>     | Automotive                 | <a href="http://www.ti.com/automotive">www.ti.com/automotive</a>                         |
| DLP® Products               | <a href="http://www.dlp.com">www.dlp.com</a>                       | Communications and Telecom | <a href="http://www.ti.com/communications">www.ti.com/communications</a>                 |
| DSP                         | <a href="http://dsp.ti.com">dsp.ti.com</a>                         | Computers and Peripherals  | <a href="http://www.ti.com/computers">www.ti.com/computers</a>                           |
| Clocks and Timers           | <a href="http://www.ti.com/clocks">www.ti.com/clocks</a>           | Consumer Electronics       | <a href="http://www.ti.com/consumer-apps">www.ti.com/consumer-apps</a>                   |
| Interface                   | <a href="http://interface.ti.com">interface.ti.com</a>             | Energy                     | <a href="http://www.ti.com/energy">www.ti.com/energy</a>                                 |
| Logic                       | <a href="http://logic.ti.com">logic.ti.com</a>                     | Industrial                 | <a href="http://www.ti.com/industrial">www.ti.com/industrial</a>                         |
| Power Mgmt                  | <a href="http://power.ti.com">power.ti.com</a>                     | Medical                    | <a href="http://www.ti.com/medical">www.ti.com/medical</a>                               |
| Microcontrollers            | <a href="http://microcontroller.ti.com">microcontroller.ti.com</a> | Security                   | <a href="http://www.ti.com/security">www.ti.com/security</a>                             |
| RFID                        | <a href="http://www.ti-rfid.com">www.ti-rfid.com</a>               | Space, Avionics & Defense  | <a href="http://www.ti.com/space-avionics-defense">www.ti.com/space-avionics-defense</a> |
| RF/IF and ZigBee® Solutions | <a href="http://www.ti.com/lprf">www.ti.com/lprf</a>               | Video and Imaging          | <a href="http://www.ti.com/video">www.ti.com/video</a>                                   |
|                             |  | Wireless                   | <a href="http://www.ti.com/wireless-apps">www.ti.com/wireless-apps</a>                   |

Mailing Address: Texas Instruments, Post Office Box 655303, Dallas, Texas 75265  
Copyright © 2010, Texas Instruments Incorporated