



**ABRACON Crystal Specification for
Micrel Semiconductor MICRF Series RF Transceiver**

ABRACON P/N for MICRF Chip	For use with Micrel Chip P/N
ABLS-6.7458MHz-20-R60-D	MICRF011-002-007
ABLS-13.560MHz-10-R20-D	MICRF102
ABLS-4.897MHz-20-R70-D	MICRF011-002-007
ABLS-9.84375MHz-10-R20-D	MICRF102
ABLS-9.7941MHz-10-R20	MICRF009-010
ABLS-13.94916MHz-10-R20	MICRF009-010
ABLS-12.1875MHz-10-R20	MICRF112
ABLS-13.0625MHz-10-R20	MICRF112
ABLS-13.6050MHz-20-R50-D	MICRF505
ABLS-13.94916MHz-10-R20-D	MICRF009-010
ABLS-14.3359MHz-20-R50	MICRF505
ABM9-16.000MHz-10-D-1-U	MICRF505-509
ABM3B-12.1875MHz-10-D4	MICRF112
ABM3B-13.0625MHz-10-D4	MICRF112

PROPRIETARY NOTICE

These documents, and the contained information herein, are proprietary and are not to be reproduced, used or disclosed to others for manufacture or for any other purpose, except as specifically authorized, in writing, by ABRACON Corporation.

ABRACON CORPORATION

Headquarters
30332 Esperanza, Rancho Santa Margarita
California, The USA.
Tel : 949-546-8000
Fax: 949-546-8001

WARNING: ESD SENSITIVE PRODUCT

				TITLE ABRACON Crystal Specification for Micrel Semiconductor MICRF Series RF Transceiver		
PREP. EP	DATE 4/18/2007	ENGR. HU	DATE 4/18/2007	SCALE None	DRAWING NO. -----	REV. -
CKD ---	DATE ---	APP'D CP	DATE 4/18/2007	PAGE OF 1 7		

1.0 SCOPE

This specification describes specifications of ABRACON's crystals for Micrel Semiconductor's IC's.

2.0 ELECTRICAL SPECIFICATIONS

2.1 Individual Specifications

ABRACON P/N	Frequency (MHz)	Load Cap. (pF)	Operating Temp. (°C)	Storage Temp. (°C)	ESR (ohms)	Frequency Tolerance (ppm)	Temperature Stability (ppm)
ABLS-6.7458MHz-20-R60-D	6.74580	20	-40 to +85	-40 to +85	60	±50	±50
ABLS-13.560MHz-10-R20-D	13.56000	10	-40 to +85	-40 to +85	20	±50	±50
ABLS-4.897MHz-20-R70-D	4.89700	20	-40 to +85	-40 to +85	70	±50	±50
ABLS-9.84375MHz-10-R20-D	9.84375	10	-40 to +85	-40 to +85	20	±50	±50
ABLS-9.7941MHz-10-R20	9.79410	10	0 to +70	-40 to +85	20	±50	±50
ABLS-13.94916MHz-10-R20	13.94916	10	0 to +70	-40 to +85	20	±50	±50
ABLS-12.1875MHz-10-R20	12.18750	10	0 to +70	-40 to +85	20	±50	±50
ABLS-13.0625MHz-10-R20	13.06250	10	0 to +70	-40 to +85	20	±50	±50
ABLS-13.6050MHz-20-R50-D	13.60500	20	-40 to +85	-40 to +85	50	±50	±50
ABLS-13.94916MHz-10-R20-D	13.94916	10	-40 to +85	-40 to +85	20	±50	±50
ABLS-14.3359MHz-20-R50	14.33590	20	0 to +70	-40 to +85	50	±50	±50
ABM9-16.000MHz-10-D-1-U	16.00000	10	-40 to +85	-40 to +105	80	±10	±10
ABM3B-12.1875MHz-10-D4	12.18750	10	-40 to +85	-40 to +85	70	±30	±50
ABM3B-13.0625MHz-10-D4	13.06250	10	-40 to +85	-40 to +85	70	±30	±50

2.2 Common Specifications

Shunt capacitance C0:

7 pF max.

Operation mode:

AT-cut Fundamental

Drive level:

1 mW max., 100µW Typical (ABLS)

100 uW max., 10µW Typical (AM9 and

Aging @ 25° C per a year :

± 5 ppm max.

Insulation resistance:

500 MΩ min. at 100Vdc ± 15V

Spurious responses:

-3dB max.

3.0 SPECIAL REQUIREMENT

This product is RoHS compliant and Pb free.

4.0 MARKING

Marking Method : Laser Marking

4.1 ABL Series

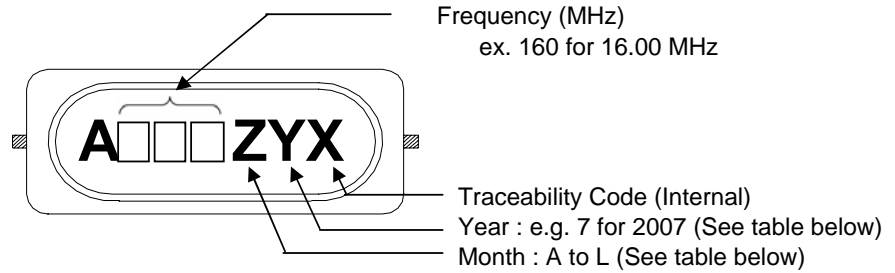

4.2 ABM9 Series

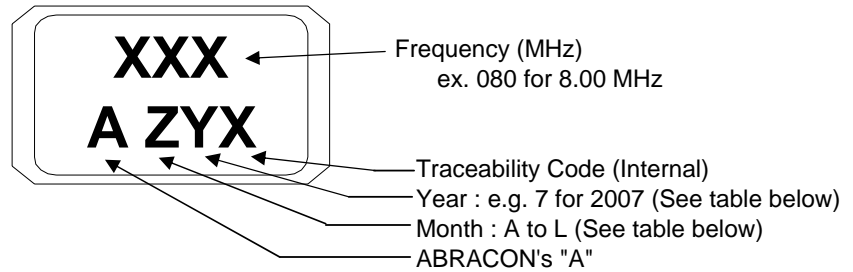

4.3 ABM3B Series

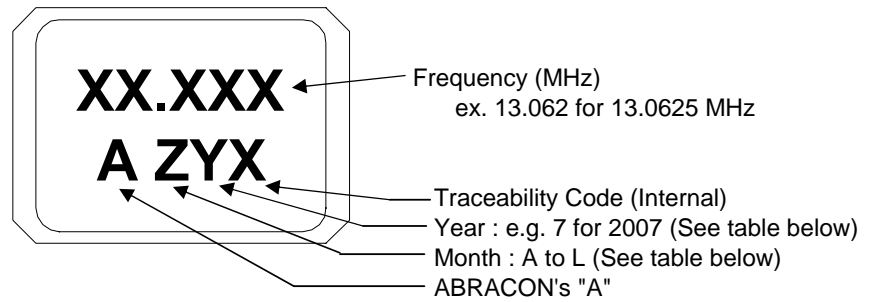

4.2.1 Marking Method : Laser Marking

Date Code

Month	Code
January	A
February	B
March	C
April	D
May	E
June	F
July	G
August	H
September	I
October	J
November	K
December	L

5.0 OUTLINE DIMENSIONS

5.1 ABL5 Series

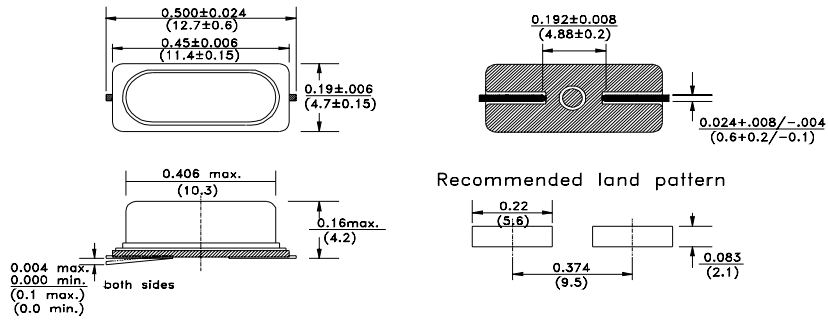

5.2 ABM9 Series

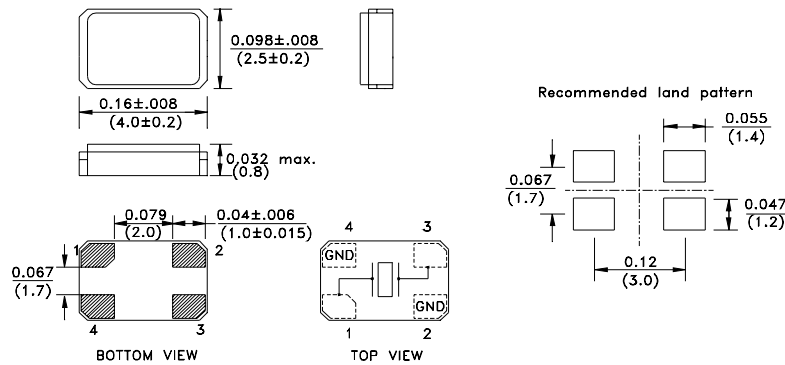

5.3 ABM3B Series

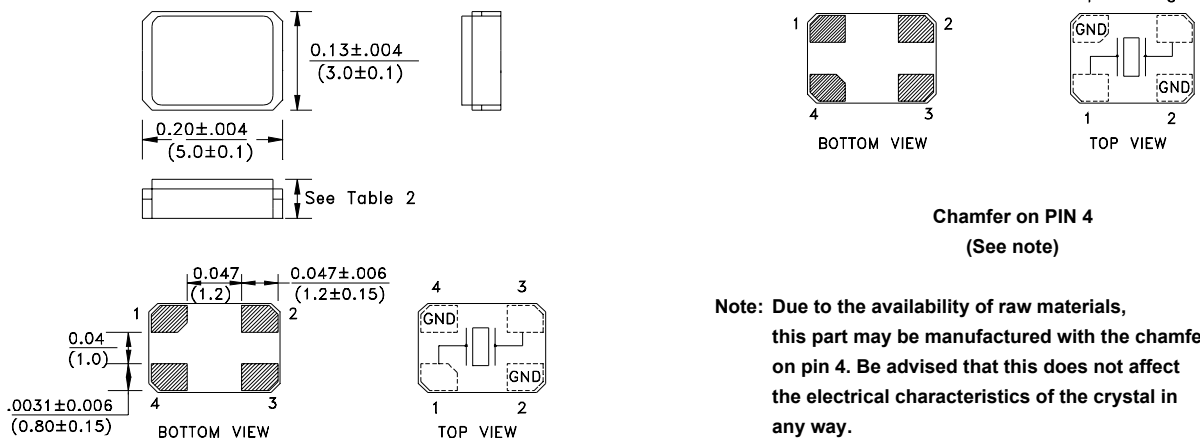

Chamfer on PIN 4
(See note)

Note: Due to the availability of raw materials, this part may be manufactured with the chamfer on pin 4. Be advised that this does not affect the electrical characteristics of the crystal in any way.

Chamfer on PIN 1
(Default)

Dimension : mm

TOLERANCES:

UNLESS OTHERWISE SPECIFIED: .X: ± 0.1 (0.25) .XX: ± 0.01 (0.025) .XXX: ± 0.005 (0.013)

6.0 RELIABILITY TEST

No.	Test Items	Test Conditions
1	Temperature Cycling:	The component shall remain within the electrical specification (± 5 pp max) after 3 cycles of high and low temperature testing (-40°C to $+85^{\circ}\text{C}$) for 2 hours max.
2	Thermal Shock:	The component shall remain within the electrical specification after exposure at extreme temperature -40°C to $+85^{\circ}\text{C}$ for 5 minutes for 3 cycles.
3	Vibration:	The component shall remain within the electrical specification after loaded vibration at 10Hz to 55Hz, amplitude 1.5mm, within 1 minute for 2 hours minimum on each axis (X,Y,Z).
4	Drop Test:	The component shall remain within the electrical specifications after a natural drop (3X) on a hard wooden board at 75 cm.
5	Humidity:	The component shall remain within the electrical specifications after being kept at a condition of ambient temperature $+85^{\circ}\text{C}$, 85% RH for 96 hours minimum.
6	Fine Leak Test:	Expose samples to 60PSIG Helium gas for 2 hours. Max leak rate 2×10^{-8} atmcc/s.
7	Gross Leak Test:	Submerge samples in 100% De-ionized water or Perfluorocarbon at 85°C for at least 1 minute. Check for bubbles.
8	Solderability:	Solderability of terminals shall be kept at more than 95% after dipped in solder flux at $260^{\circ}\text{C} \pm 5^{\circ}\text{C}$ for 5 seconds.
9	Lead Bend: (ABLS only)	The component shall withstand maximum bend of 90°C reference to base for 2 bends. Solder tinning must be 4 microns thick minimum.

6.1 REFLOW PROFILE

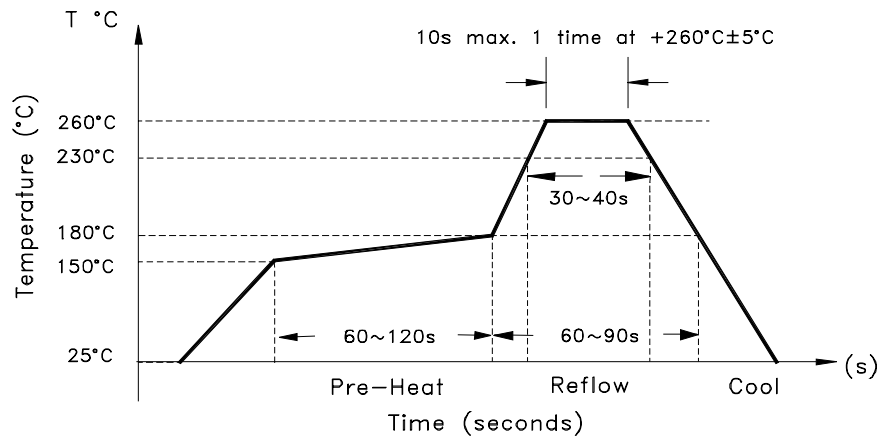

8.0 NOTE

- (1) The parts are manufactured in accordance with this specification. If other conditions and specifications which are required for this specification, please contact ABRACON for more information.
- (2) ABRACON will supply the parts in accordance with this specification unless we receive a written request to modify prior to an order placement.
- (3) In no case shall ABRACON be liable for any product failure from in appropriate handling or operation of the item beyond the scope of this specification.
- (4) When changing your production process, please notify ABRACON immediately.
- (5) If you intend to use the product for listed application which may possibly cause to loss of life or assets, please notify ABRACON in advance.
(For example, Medical, Aerospace, Aeronautic equipment, Safety control equipment as well as safety related.)
- (6) All specifications and Marking will be subject to change without notice.
- (7) See ABRACON website (www.abracon.com) for additional Terms and Conditions.