

## 13-BIT 250-MSPS ANALOG-TO-DIGITAL CONVERTER

### FEATURES

- **Controlled Baseline**
  - One Assembly
  - One Test Site
  - One Fabrication Site
- **Extended Temperature Performance of –55°C to 125°C**
- **Enhanced Diminishing Manufacturing Sources (DMS) Support**
- **Enhanced Product-Change Notification**
- **Qualification Pedigree<sup>(1)</sup>**
- **13-Bit Resolution**
- **250-MSPS Sample Rate**
- **SNR = 69 dBc at 100-MHz IF and 250 MSPS**
- **SFDR = 76 dBc at 100-MHz IF and 250 MSPS**
- **SNR = 67.7 dBc at 230-MHz IF and 250 MSPS**
- **SFDR = 77 dBc at 230-MHz IF and 250 MSPS**
- **2.2-V<sub>PP</sub> Differential Input Voltage**
- **Fully Buffered Analog Inputs**
- **5-V Analog Supply Voltage**
- **LVDS Compatible Outputs**
- **Total Power Dissipation: 2 W**
- **Offset Binary Output Format**

- **TQFP-80 PowerPAD™ Package**
- **Pin Compatible With the ADS5440**
- **Military Temperature Range = –55°C to 125°C**

<sup>(1)</sup> Component qualification in accordance with JEDEC and industry standards to ensure reliable operation over an extended temperature range. This includes, but is not limited to, Highly Accelerated Stress Test (HAST) or biased 85/85, temperature cycle, autoclave or unbiased HAST, electromigration, bond intermetallic life, and mold compound life. Such qualification testing should not be viewed as justifying use of this component beyond specified performance and environmental limits.

### APPLICATIONS

- **Test and Measurement**
- **Software-Defined Radio**
- **Multichannel Base Station Receivers**
- **Base Station Tx Digital Predistortion**
- **Communications Instrumentation**

### RELATED PRODUCTS

- **ADS5424 - 14-Bit, 105 MSPS ADC**
- **ADS5423 - 14-Bit, 80 MSPS ADC**
- **ADS5440 - 13-Bit, 210 MSPS ADC**

### DESCRIPTION

The ADS5444 is a 13-bit 250-MSPS analog-to-digital converter (ADC) that operates from a 5-V supply, while providing LVDS-compatible digital outputs from a 3.3-V supply. The ADS5444 input buffer isolates the internal switching of the onboard track and hold (T&H) from disturbing the signal source. An internal reference generator is also provided to further simplify the system design. The ADS5444 has outstanding low noise and linearity over input frequency.



Please be aware that an important notice concerning availability, standard warranty, and use in critical applications of Texas Instruments semiconductor products and disclaimers thereto appears at the end of this data sheet.

PowerPAD is a trademark of Texas Instruments.

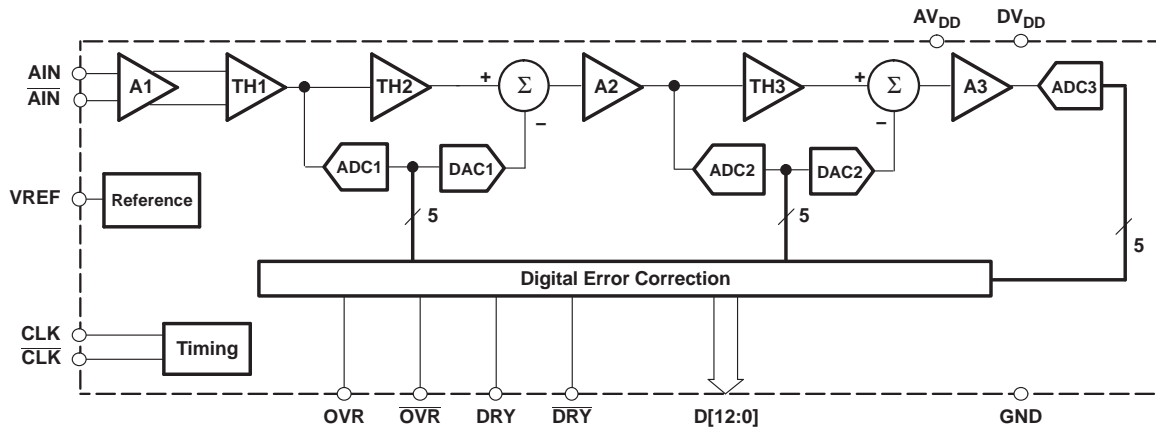

B0061-01

The ADS5444 is available in an 80-pin TQFP PowerPAD™ package. The ADS5444 is built on a state-of-the-art Texas Instruments complementary bipolar process (BiCom3X) and is specified over the full military temperature range (–55°C to 125°C).



This integrated circuit can be damaged by ESD. Texas Instruments recommends that all integrated circuits be handled with appropriate precautions. Failure to observe proper handling and installation procedures can cause damage.

ESD damage can range from subtle performance degradation to complete device failure. Precision integrated circuits may be more susceptible to damage because very small parametric changes could cause the device not to meet its published specifications.

### PACKAGING/ORDERING INFORMATION<sup>(1)</sup>

Product	Package-Lead	Package Designator <sup>(1)</sup>	Specified Temperature Range	Package Marking	Ordering Number	Transport Media, Quantity
ADS5444	HTQFP-80 <sup>(2)</sup> PowerPAD	PFP	–55°C to 125°C	ADS5444M-EP	ADS5444MPFPEP	Tray, 96

(1) For the most current product and ordering information, see the Package Option Addendum located at the end of this document, or see the TI website at [www.ti.com](http://www.ti.com).

(2) Thermal pad size: 7,5 mm x 7,5 mm (typ)

### ABSOLUTE MAXIMUM RATINGS

over operating free-air temperature range (unless otherwise noted)<sup>(1)</sup>

		VALUE / UNIT
Supply voltage	$AV_{DD}$ to GND	6 V
	$DRV_{DD}$ to GND	5 V
Analog input to GND		–0.3 V to $AV_{DD}$ + 0.3 V
Clock input to GND		–0.3 V to $AV_{DD}$ + 0.3 V
CLK to $\overline{CLK}$		±2.5 V
Digital data output to GND		–0.3 V to $DRV_{DD}$ + 0.3 V
Operating temperature range		–55°C to 125°C
Maximum junction temperature		150°C
Storage temperature range		–65°C to 150°C
ESD Human Body Model (HBM)		2.5 kV

(1) Stresses above these ratings may cause permanent damage. Exposure to absolute maximum conditions for extended periods may degrade device reliability. These are stress ratings only and functional operation of the device at these or any other conditions beyond those specified is not implied.

### THERMAL CHARACTERISTICS<sup>(1)</sup>

PARAMETER	TEST CONDITIONS	TYP	UNIT
$\theta_{JA}$	Soldered slug, no airflow	21.7	°C/W
	Soldered slug, 250-LFPM airflow	15.4	°C/W
	Unsoldered slug, no airflow	50	°C/W
	Unsoldered slug, 250-LFPM airflow	43.4	°C/W
$\theta_{JC}$	Bottom of package (heatslug)	2.99	°C/W

(1) Using 36 thermal vias (6 x 6 array). See the Application Section.

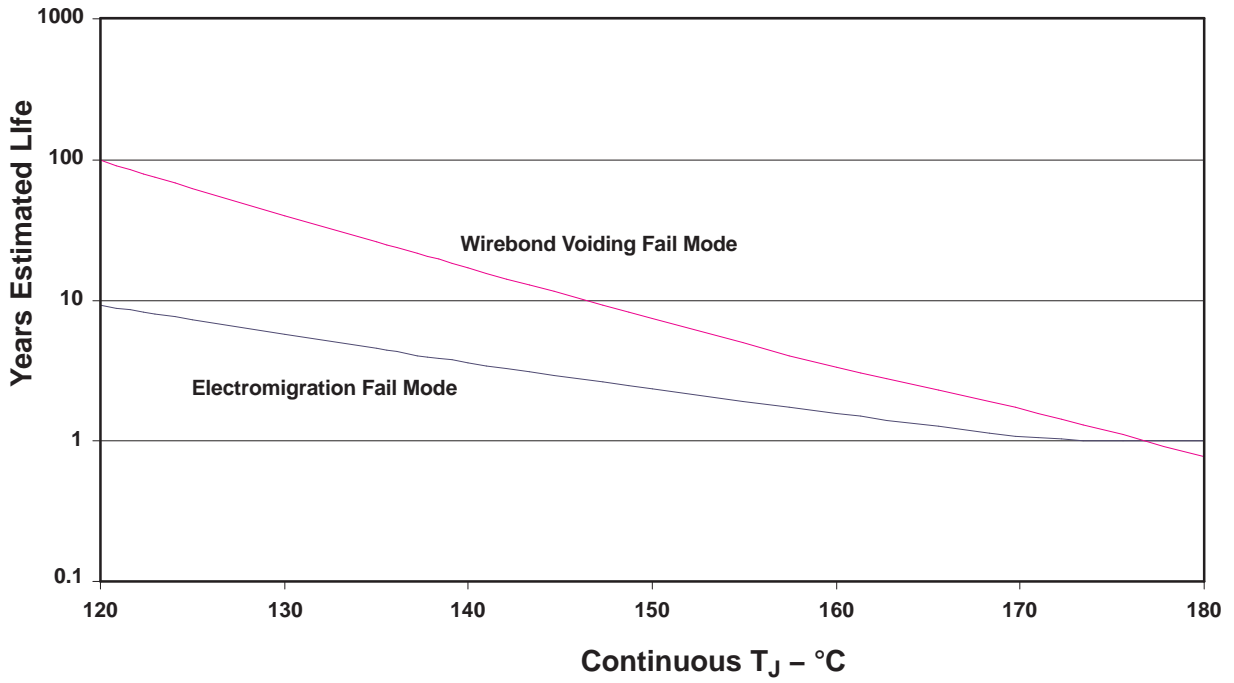

Figure 1. ADS5444MPFPEP Operating Life Derating Chart

## RECOMMENDED OPERATING CONDITIONS

		MIN	NOM	MAX	UNIT
<b>SUPPLIES</b>					
AV <sub>DD</sub>	Analog supply voltage	4.75	5	5.25	V
DRV <sub>DD</sub>	Output driver supply voltage	3	3.3	3.6	V
<b>ANALOG INPUT</b>					
Differential input range		2.2			V <sub>PP</sub>
V <sub>CM</sub>	Input common mode	2.4			V
<b>CLOCK INPUT</b>					
1/t <sub>C</sub>	ADCLK input sample rate (sine wave)	10	250		MSPS
Clock amplitude, differential sine wave		3			V <sub>PP</sub>
Clock duty cycle		50%			
T <sub>A</sub>	Open free-air temperature	–55	125		°C

## ELECTRICAL CHARACTERISTICS

Min, Typ, and Max values at T<sub>A</sub> = 25°C, full temperature range is T<sub>MIN</sub> = –55°C to T<sub>MAX</sub> = 125°C, sampling rate = 250 MSPS, 50% clock duty cycle, AV<sub>DD</sub> = 5 V, DRV<sub>DD</sub> = 3.3 V, –1-dBFS differential input, and 3-V<sub>PP</sub> differential clock (unless otherwise noted)

PARAMETER		TEST CONDITIONS		MIN	TYP	MAX	UNIT
Resolution				13			Bits
<b>ANALOG INPUTS</b>							
Differential input range				2.2			V <sub>pp</sub>
Differential input resistance (DC)				1			kΩ
Differential input capacitance				1.5			pF
Analog input bandwidth				800			MHz
<b>INTERNAL REFERENCE VOLTAGE</b>							
VREF	Reference voltage			2.4			V
<b>DYNAMIC ACCURACY</b>							
No missing codes				Assured			
DNL	Differential linearity error	f <sub>IN</sub> = 10 MHz	T <sub>A</sub> = 25°C	–1	±0.4	1	LSB
			Full temp range	–1	±0.4	2	
INL	Integral linearity error	f <sub>IN</sub> = 10 MHz	T <sub>A</sub> = 25°C	–2.2	±0.9	2.2	LSB
			Full temp range	–4.3	±2.7	4.3	
Offset error				–11	11		mV
Offset temperature coefficient				0.0005			mV/°C
Gain error				–5	5		%FS
Gain temperature coefficient				–0.02			Δ%/°C
PSRR		f <sub>IN</sub> = 100 MHz			1	mV/V	
<b>POWER SUPPLY</b>							
I <sub>AVDD</sub>	Analog supply current			340	430	mA	
I <sub>DRVDD</sub>	Output buffer supply current	V <sub>IN</sub> = full scale, f <sub>IN</sub> = 100 MHz, F <sub>S</sub> = 250 MSPS		80	100	mA	
Power dissipation				2	2.37	W	

**ELECTRICAL CHARACTERISTICS (continued)**

Min, Typ, and Max values at  $T_A = 25^\circ\text{C}$ , full temperature range is  $T_{\text{MIN}} = -55^\circ\text{C}$  to  $T_{\text{MAX}} = 125^\circ\text{C}$ , sampling rate = 250 MSPS, 50% clock duty cycle,  $AV_{\text{DD}} = 5\text{ V}$ ,  $DRV_{\text{DD}} = 3.3\text{ V}$ , -1-dBFS differential input, and 3- $V_{\text{PP}}$  differential clock (unless otherwise noted)

PARAMETER		TEST CONDITIONS		MIN	TYP	MAX	UNIT	
<b>DYNAMIC AC CHARACTERISTICS</b>								
SNR	Signal-to-noise ratio	$f_{\text{IN}} = 10\text{ MHz}$				69.3	dBc	
		$f_{\text{IN}} = 70\text{ MHz}$				69		
		$f_{\text{IN}} = 100\text{ MHz}$	$T_A = 25^\circ\text{C}$		67	69		
			Full temp range		64.25	69		
		$f_{\text{IN}} = 170\text{ MHz}$				68.3		
		$f_{\text{IN}} = 230\text{ MHz}$				67.7		
		$f_{\text{IN}} = 300\text{ MHz}$				67		
$f_{\text{IN}} = 400\text{ MHz}$				66				
SFDR	Spurious free dynamic range	$f_{\text{IN}} = 10\text{ MHz}$				85	dBc	
		$f_{\text{IN}} = 70\text{ MHz}$				77		
		$f_{\text{IN}} = 100\text{ MHz}$	$T_A = 25^\circ\text{C}$		70	77		
			Full temp range		64	77		
		$f_{\text{IN}} = 170\text{ MHz}$				74		
		$f_{\text{IN}} = 230\text{ MHz}$				77		
		$f_{\text{IN}} = 300\text{ MHz}$				70		
$f_{\text{IN}} = 400\text{ MHz}$				64				
HD2	Second harmonic	$f_{\text{IN}} = 10\text{ MHz}$				87	dBc	
		$f_{\text{IN}} = 70\text{ MHz}$				77		
		$f_{\text{IN}} = 100\text{ MHz}$				80		
		$f_{\text{IN}} = 170\text{ MHz}$				74		
		$f_{\text{IN}} = 230\text{ MHz}$				78		
		$f_{\text{IN}} = 300\text{ MHz}$				70		
		$f_{\text{IN}} = 400\text{ MHz}$				64		
HD3	Third harmonic	$f_{\text{IN}} = 10\text{ MHz}$				86	dBc	
		$f_{\text{IN}} = 70\text{ MHz}$				82		
		$f_{\text{IN}} = 100\text{ MHz}$				79		
		$f_{\text{IN}} = 170\text{ MHz}$				80		
		$f_{\text{IN}} = 230\text{ MHz}$				91		
		$f_{\text{IN}} = 300\text{ MHz}$				80		
		$f_{\text{IN}} = 400\text{ MHz}$				69		
Worst other harmonic/spur (other than HD2 and HD3)		$f_{\text{IN}} = 10\text{ MHz}$				90	dBc	
		$f_{\text{IN}} = 70\text{ MHz}$				95		
		$f_{\text{IN}} = 100\text{ MHz}$				82		
		$f_{\text{IN}} = 170\text{ MHz}$				80		
		$f_{\text{IN}} = 230\text{ MHz}$				83		
		$f_{\text{IN}} = 300\text{ MHz}$				86		
		$f_{\text{IN}} = 400\text{ MHz}$				85		

### ELECTRICAL CHARACTERISTICS (continued)

Min, Typ, and Max values at  $T_A = 25^\circ\text{C}$ , full temperature range is  $T_{\text{MIN}} = -55^\circ\text{C}$  to  $T_{\text{MAX}} = 125^\circ\text{C}$ , sampling rate = 250 MSPS, 50% clock duty cycle,  $AV_{\text{DD}} = 5\text{ V}$ ,  $DRV_{\text{DD}} = 3.3\text{ V}$ ,  $-1\text{-dBFS}$  differential input, and  $3\text{-}V_{\text{PP}}$  differential clock (unless otherwise noted)

PARAMETER		TEST CONDITIONS	MIN	TYP	MAX	UNIT
SINAD		$f_{\text{IN}} = 10\text{ MHz}$		69		dBc
		$f_{\text{IN}} = 70\text{ MHz}$		68		
		$f_{\text{IN}} = 100\text{ MHz}$		67.6		
		$f_{\text{IN}} = 170\text{ MHz}$		66.5		
		$f_{\text{IN}} = 230\text{ MHz}$		67		
		$f_{\text{IN}} = 300\text{ MHz}$		65		
		$f_{\text{IN}} = 400\text{ MHz}$		61		
ENOB	Effective number of bits	$f_{\text{IN}} = 10\text{ MHz}$		11.2		Bits
	RMS idle channel noise	Inputs tied to common-mode		0.4		LSB
<b>DIGITAL CHARACTERISTICS – LVDS DIGITAL OUTPUTS</b>						
	Differential output voltage		0.247		0.452	V
	Output offset voltage		1.125	1.25	1.375	V

**TIMING CHARACTERISTICS**

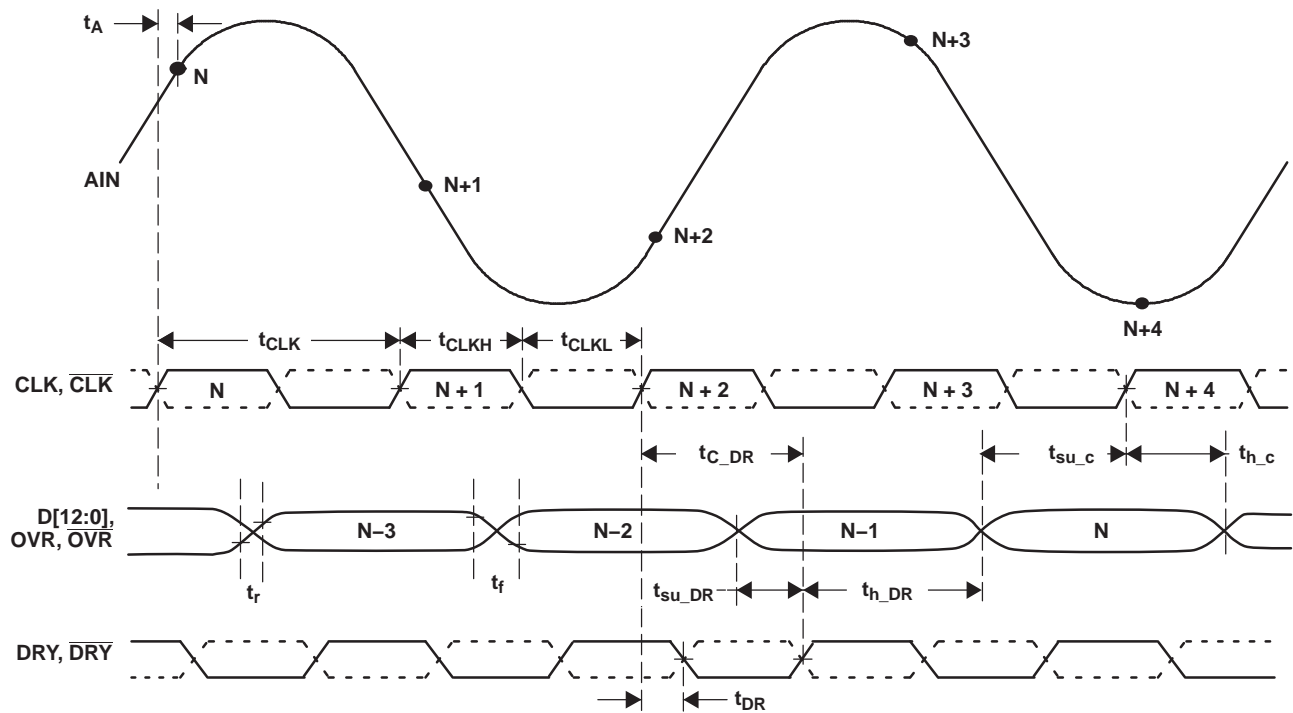

T0073-01

**Figure 2. Timing Diagram**

**TIMING CHARACTERISTICS**

Min, Typ, Max over full temperature range, 50% clock duty cycle, sampling rate = 250 MSPS, AV<sub>DD</sub> = 5 V, DRV<sub>DD</sub> = 3.3 V

PARAMETER	TEST CONDITIONS	MIN	TYP	MAX	UNIT
t <sub>A</sub> Aperture delay			500		ps
t <sub>J</sub> Clock slope independent aperture uncertainty (jitter)			200		fs RMS
Latency			4		cycles
<b>Clock Input</b>					
t <sub>CLK</sub> Clock period			4		ns
t <sub>CLKH</sub> Clock pulse width high			2		ns
t <sub>CLKL</sub> Clock pulse width low			2		ns
<b>Clock to DataReady (DRY)</b>					
t <sub>DR</sub> Clock rising to DataReady falling			1.1		ns
t <sub>C_DR</sub> Clock rising to DataReady rising	Clock duty cycle = 50% <sup>(1)</sup>	2.7	3.1	3.5	ns
<b>Clock to DATA, OVR<sup>(2)</sup></b>					
t <sub>r</sub> Data rise time (20% to 80%)			0.6		ns
t <sub>f</sub> Data fall time(80% to 20%)			0.6		ns
t <sub>su_c</sub> Data valid to clock (setup time)			3.1		ns
t <sub>h_c</sub> Clock to invalid Data (hold time)			0.2		ns
<b>DataReady (DRY)/DATA, OVR<sup>(2)</sup></b>					
t <sub>su(DR)</sub> Data valid to DRY		1.7	2		ns
t <sub>h(DR)</sub> DRY to invalid Data		0.9	1.3		ns

(1) t<sub>C\_DR</sub> = t<sub>DR</sub> + t<sub>CLKH</sub> for clock duty cycles other than 50%  
 (2) Data is updated with clock falling edge or DRY rising edge.



**DEVICE INFORMATION**

**PFP PACKAGE  
(TOP VIEW)**

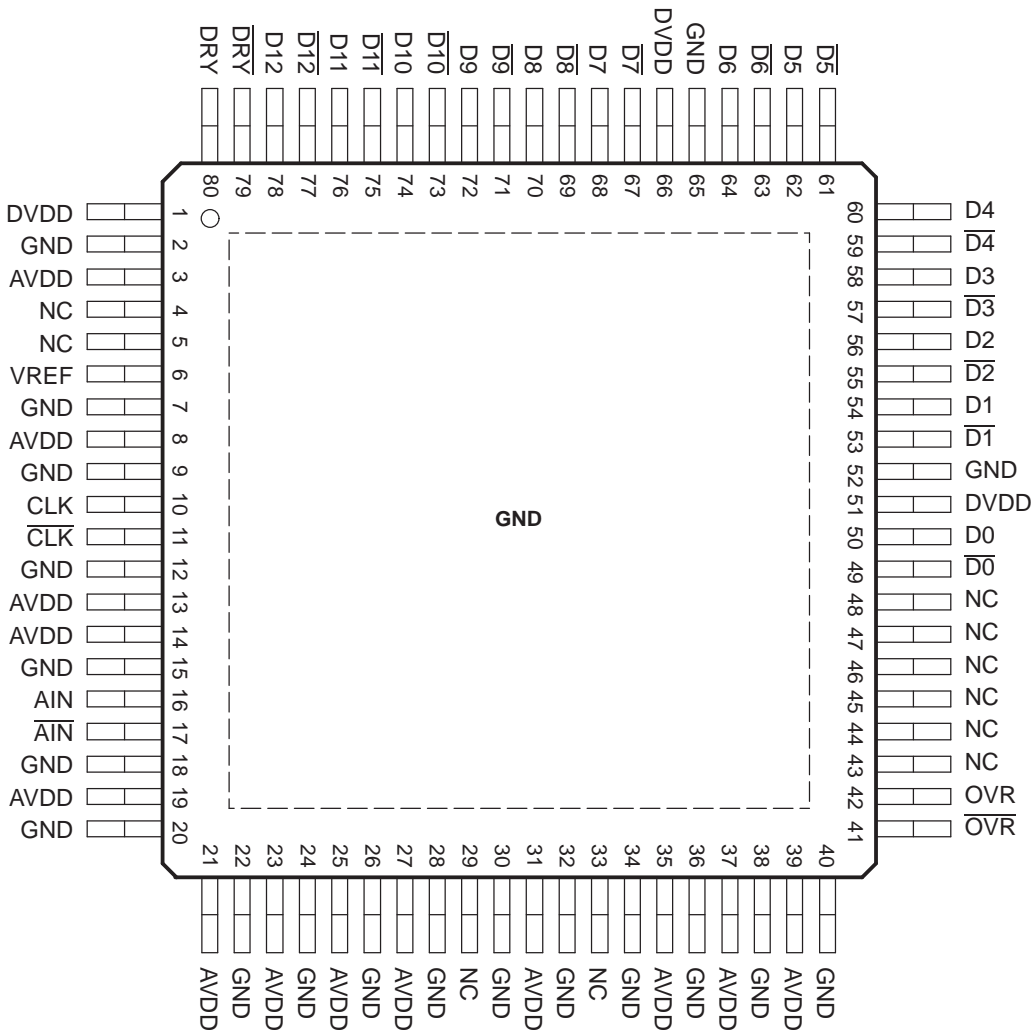

P0027-01

**DEVICE INFORMATION (continued)**  
**TERMINAL FUNCTIONS**

TERMINAL		DESCRIPTION
NAME	NO.	
AVDD	3, 8, 13, 14, 19, 21, 23, 25, 27, 31, 35, 37, 39	Analog power supply
DVDD	1, 51, 66	Output driver power supply
GND	2, 7, 9, 12, 15, 18, 20, 22, 24, 26, 28, 30, 32, 34, 36, 38, 40, 52, 65	Ground
VREF	6	Reference voltage
CLK	10	Differential input clock (positive). Conversion initiated on rising edge.
$\overline{\text{CLK}}$	11	Differential input clock (negative)
AIN	16	Differential input signal (positive)
$\overline{\text{AIN}}$	17	Differential input signal (negative)
OVR, $\overline{\text{OVR}}$	42, 41	Over range indicator LVDS output. A logic high signals an analog input in excess of the full-scale range.
D0, $\overline{\text{D0}}$	50, 49	LVDS digital output pair, least-significant bit (LSB)
D1–D6, $\overline{\text{D1}}\text{--}\overline{\text{D6}}$	53–64	LVDS digital output pairs
D7–D11, $\overline{\text{D7}}\text{--}\overline{\text{D11}}$	67–76	LVDS digital output pairs
D12, $\overline{\text{D12}}$	78, 77	LVDS digital output pair, most-significant bit (MSB)
DRY, $\overline{\text{DRY}}$	80, 79	Data ready LVDS output pair
NC	4, 5, 29, 33, 43–48	No connect

**DEFINITION OF SPECIFICATIONS**

**Analog Bandwidth** The analog input frequency at which the power of the fundamental is reduced by 3 dB with respect to the low frequency value.

**Aperture Delay** The delay in time between the rising edge of the input sampling clock and the actual time at which the sampling occurs.

**Aperture Uncertainty (Jitter)** The sample-to-sample variation in aperture delay.

**Clock Pulse Width/Duty Cycle** The duty cycle of a clock signal is the ratio of the time the clock signal remains at a logic high (clock pulse width) to the period of the clock signal. Duty cycle is typically expressed as a percentage. A perfect differential sine wave clock results in a 50% duty cycle.

**Maximum Conversion Rate** The maximum sampling rate at which certified operation is given. All parametric testing is performed at this sampling rate unless otherwise noted.

**Minimum Conversion Rate** The minimum sampling rate at which the ADC functions.

**Differential Nonlinearity (DNL)** An ideal ADC exhibits code transitions at analog input values spaced exactly 1 LSB apart. The DNL is the deviation of any single step from this ideal value, measured in units of LSB.

**Integral Nonlinearity (INL)** The INL is the deviation of the ADCs transfer function from a best fit line determined by a least squares curve fit of that transfer function. The INL at each analog input value is the difference between the actual transfer function and this best fit line, measured in units of LSB.

**Gain Error** The gain error is the deviation of the ADCs actual input full-scale range from its ideal value. The gain error is given as a percentage of the ideal input full-scale range.

**Offset Error** Offset error is the deviation of output code from mid-code when both inputs are tied to common-mode.

**Temperature Drift** Temperature drift (with respect to gain error and offset error) specifies the change from the value at the nominal temperature to the value at  $T_{\text{MIN}}$  or  $T_{\text{MAX}}$ . It is computed as the maximum variation the parameters over the whole temperature range divided by  $T_{\text{MIN}} - T_{\text{MAX}}$ .

**Signal-to-Noise Ratio (SNR)** SNR is the ratio of the power of the fundamental ( $P_S$ ) to the noise floor power ( $P_N$ ), excluding the power at dc and the first five harmonics.

## DEFINITION OF SPECIFICATIONS (continued)

$$\text{SNR} = 10 \log_{10} \frac{P_S}{P_N} \quad (1)$$

SNR is either given in units of dBc (dB to carrier) when the absolute power of the fundamental is used as the reference, or dBFS (dB to full scale) when the power of the fundamental is extrapolated to the converter's full-scale range.

**Signal-to-Noise and Distortion (SINAD)** SINAD is the ratio of the power of the fundamental ( $P_S$ ) to the power of all the other spectral components including noise ( $P_N$ ) and distortion ( $P_D$ ), but excluding dc.

$$\text{SINAD} = 10 \log_{10} \frac{P_S}{P_N + P_D} \quad (2)$$

SINAD is either given in units of dBc (dB to carrier) when the absolute power of the fundamental is used as the reference, or dBFS (dB to full scale) when the power of the fundamental is extrapolated to the converter's full-scale range.

**Effective Resolution Bandwidth** The highest input frequency where the SNR (dB) is dropped by 3 dB for a full-scale input amplitude.

**Total Harmonic Distortion (THD)** THD is the ratio of the power of the fundamental ( $P_S$ ) to the power of the first five harmonics ( $P_D$ ).

$$\text{THD} = 10 \log_{10} \frac{P_S}{P_D} \quad (3)$$

THD is typically given in units of dBc (dB to carrier).

**Two-Tone Intermodulation Distortion** IMD3 is the ratio of the power of the fundamental (at frequencies  $f_1, f_2$ ) to the power of the worst spectral component at either frequency  $2f_1 - f_2$  or  $2f_2 - f_1$ . IMD3 is either given in units of dBc (dB to carrier) when the absolute power of the fundamental is used as the reference or dBFS (dB to full scale) when the power of the fundamental is extrapolated to the converter's full-scale range.

TYPICAL CHARACTERISTICS

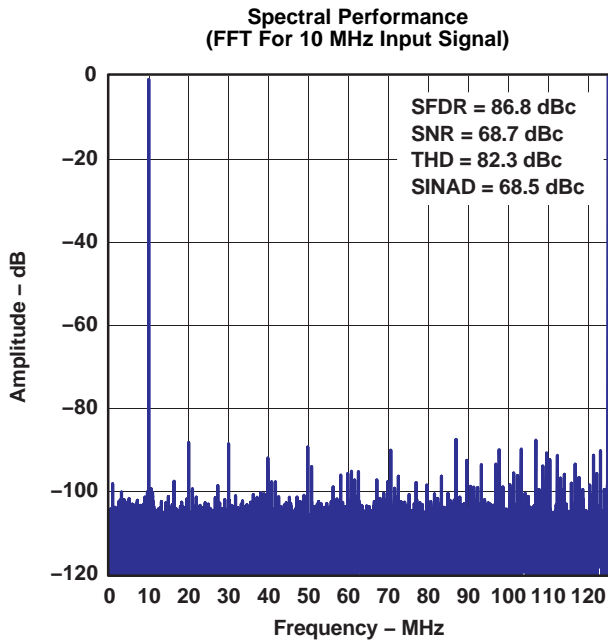

Figure 3.

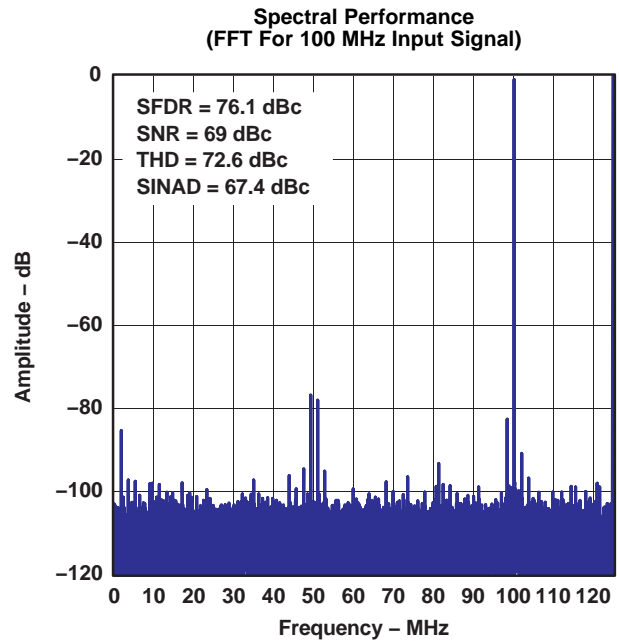

Figure 4.

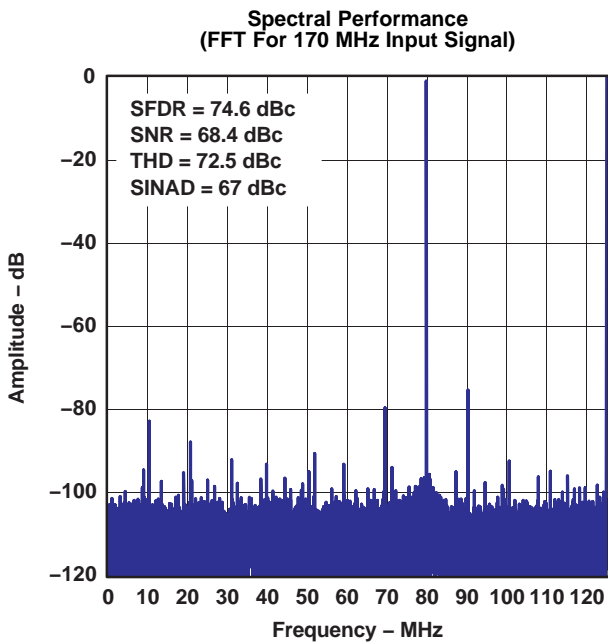

Figure 5.

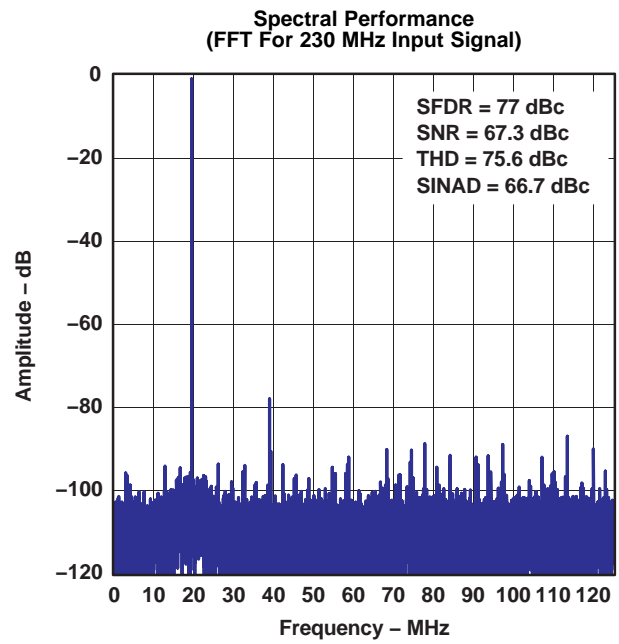

Figure 6.

**TYPICAL CHARACTERISTICS (continued)**

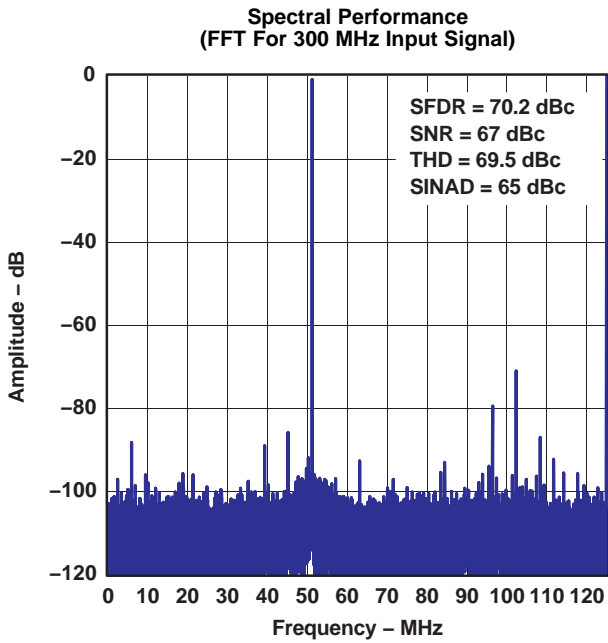

Figure 7.

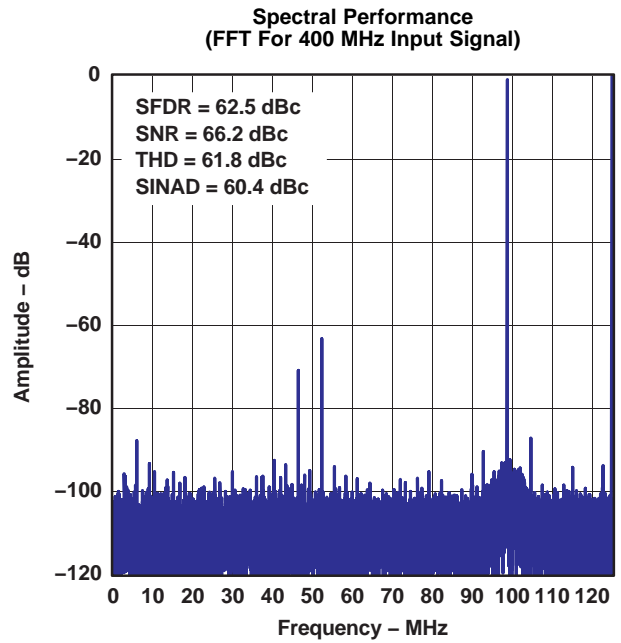

Figure 8.

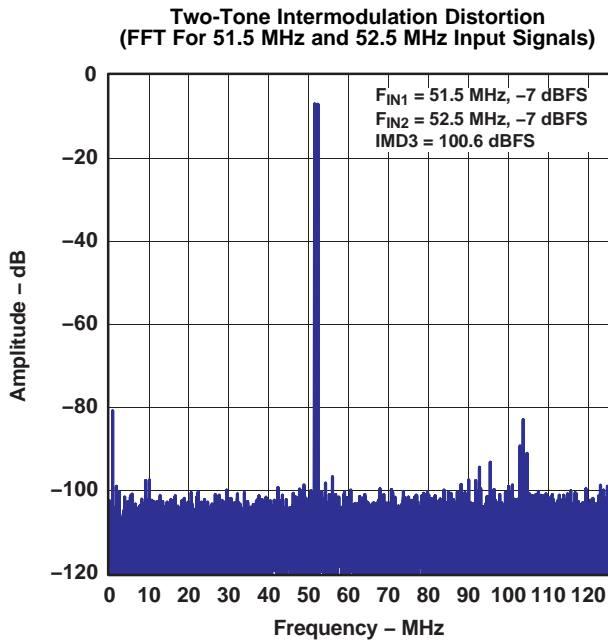

Figure 9.

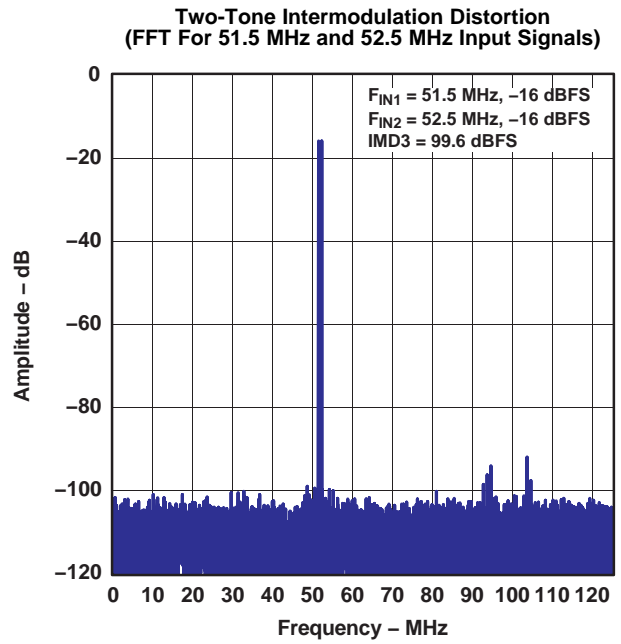
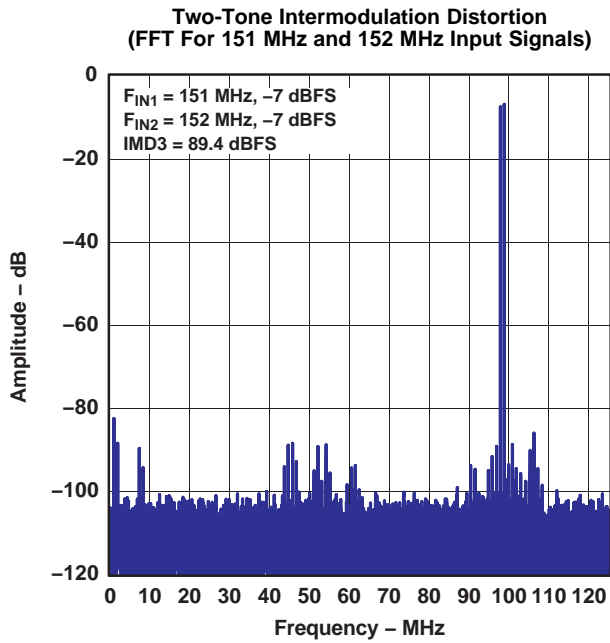

Figure 10.

**TYPICAL CHARACTERISTICS (continued)**



G009

Figure 11.

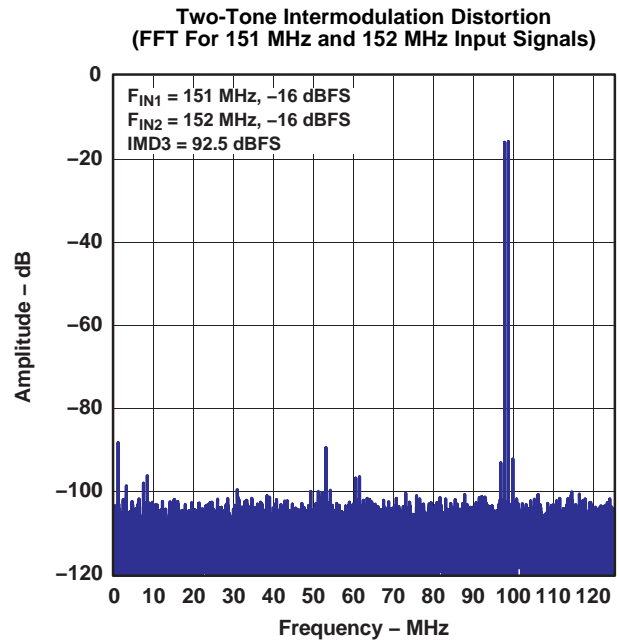

G010

Figure 12.

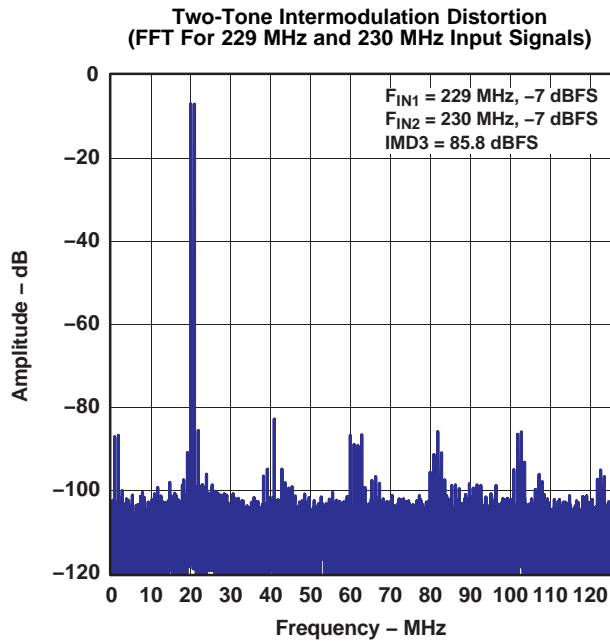

G011

Figure 13.

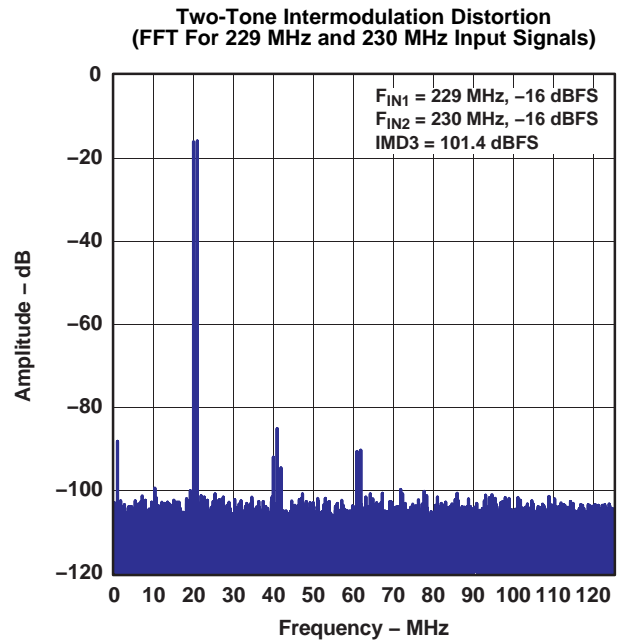

G012

Figure 14.

**TYPICAL CHARACTERISTICS (continued)**

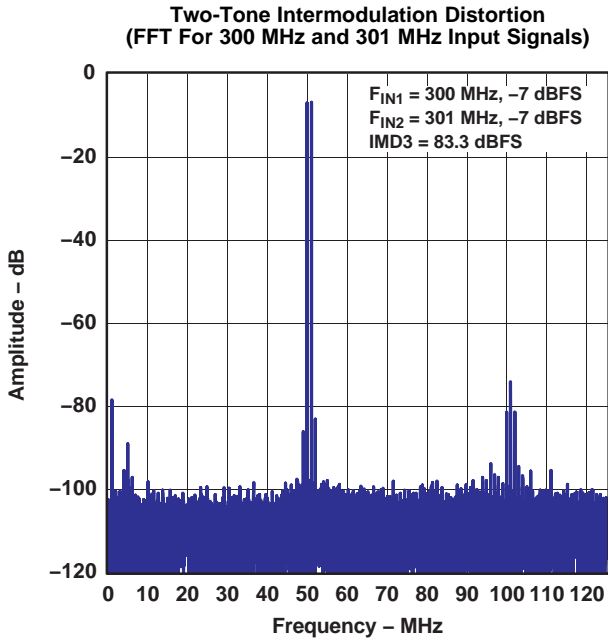

Figure 15.

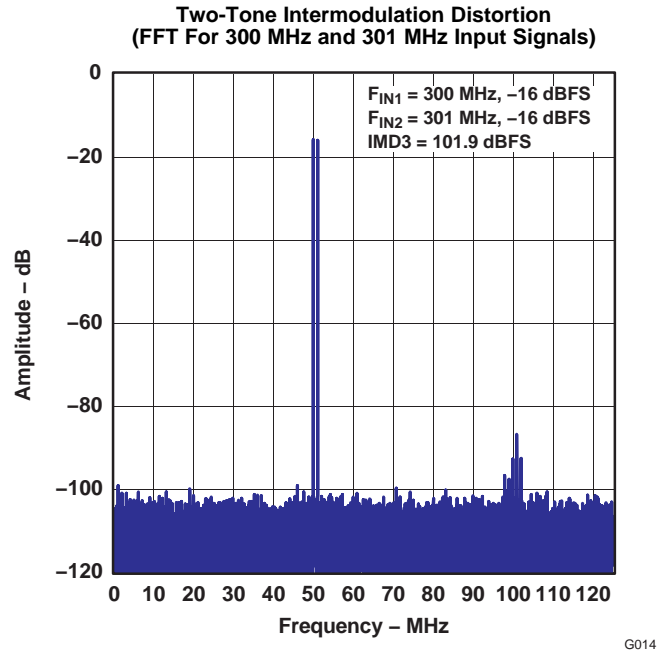

Figure 16.

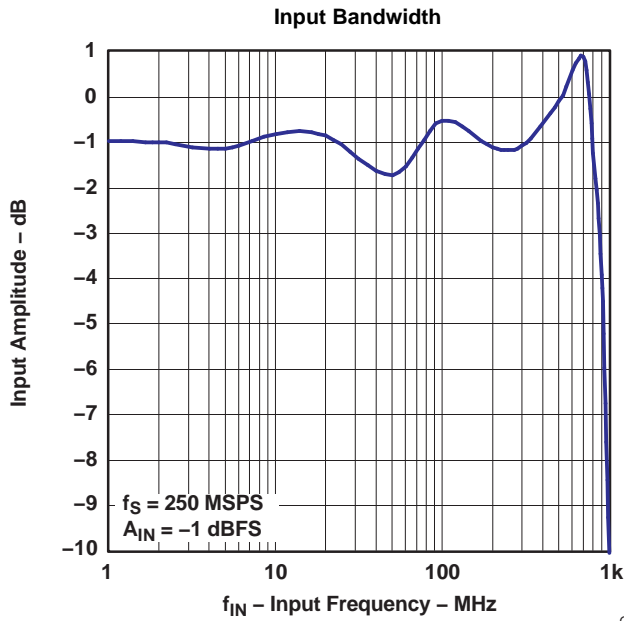

Figure 17.

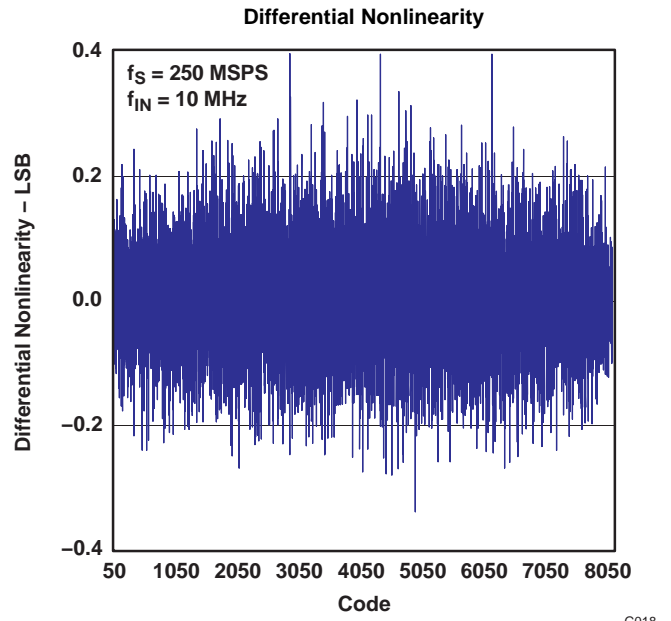
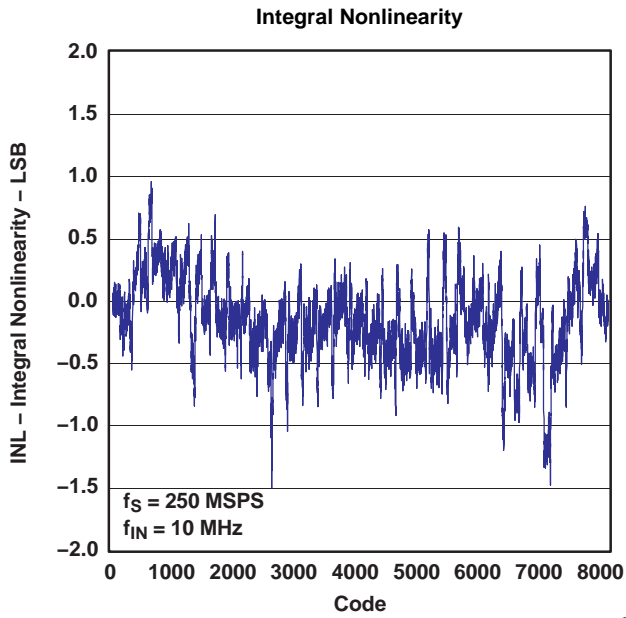

Figure 18.

TYPICAL CHARACTERISTICS (continued)



G019

Figure 19.

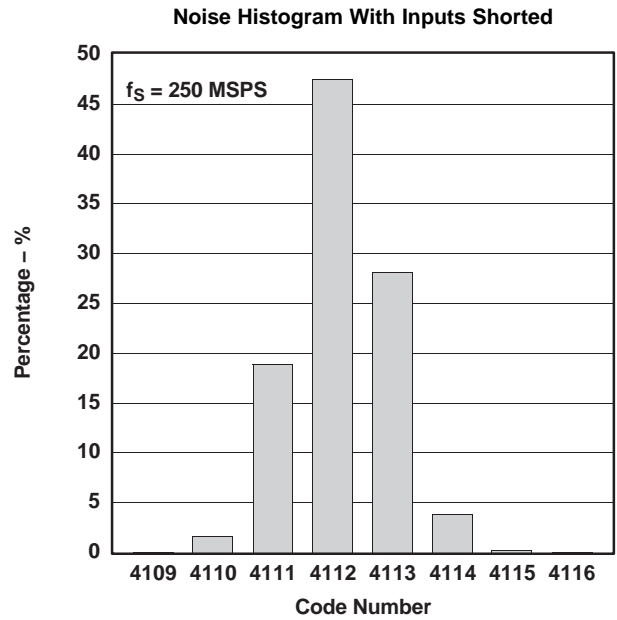

G020

Figure 20.

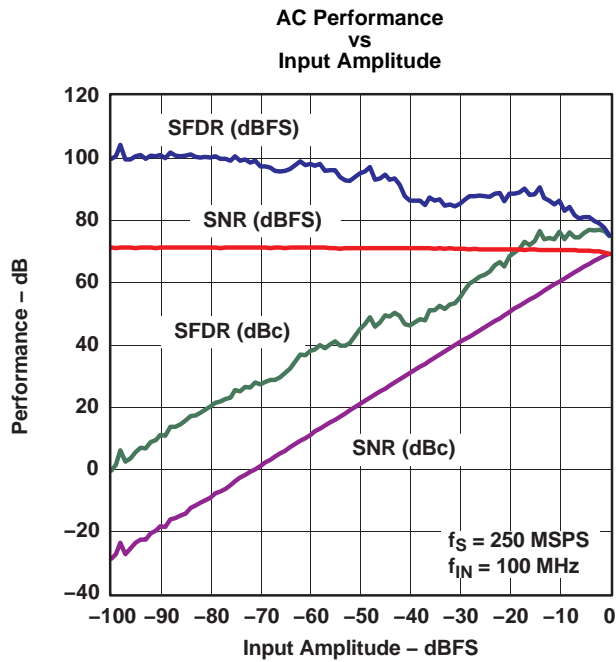

G021

Figure 21.

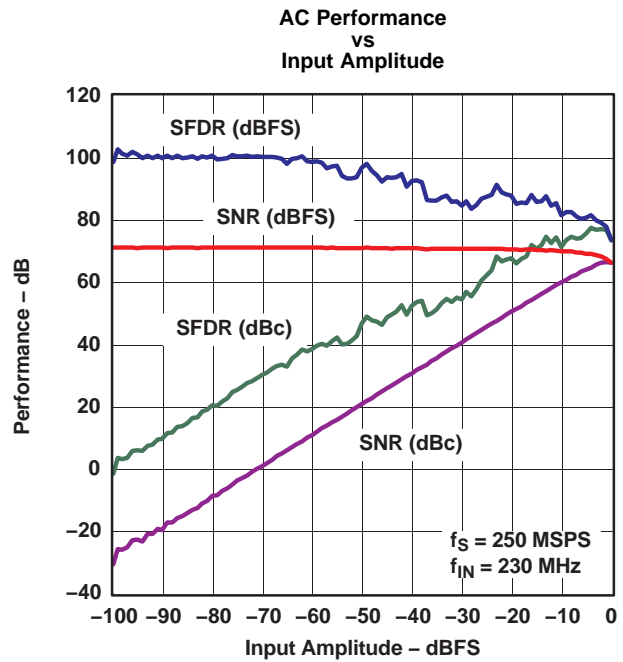

G022

Figure 22.



TYPICAL CHARACTERISTICS (continued)

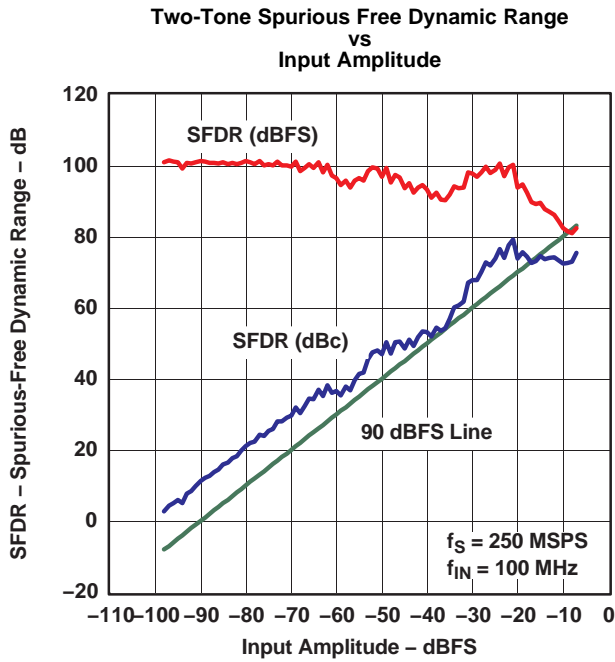

Figure 23.

G023

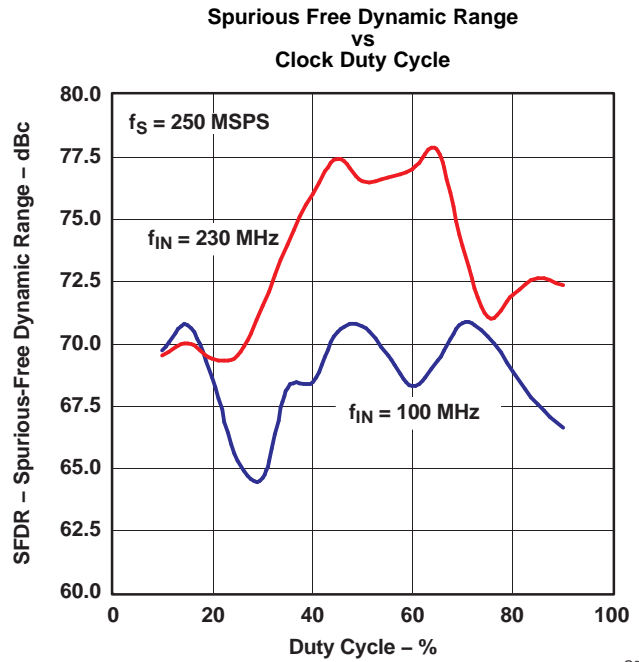

Figure 24.

G024

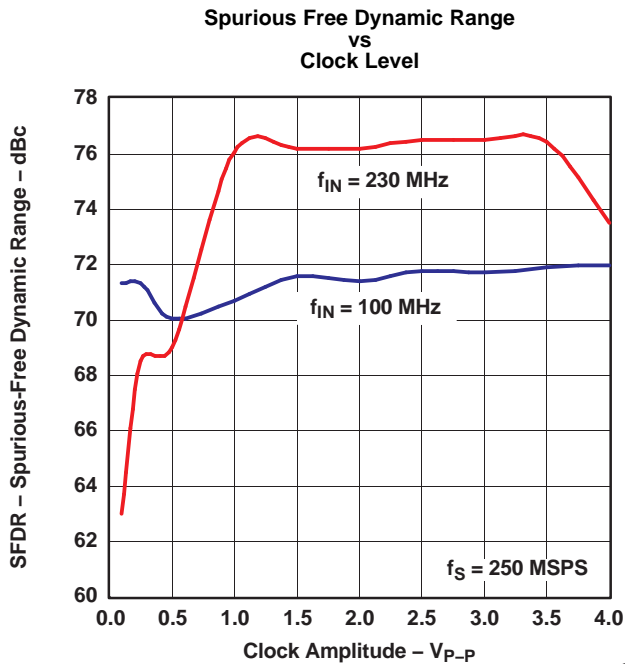

Figure 25.

G025

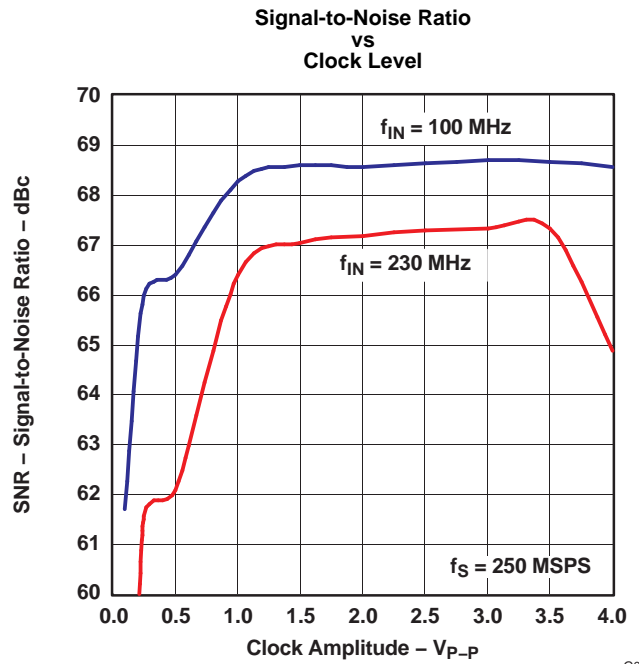

Figure 26.

G026

TYPICAL CHARACTERISTICS (continued)

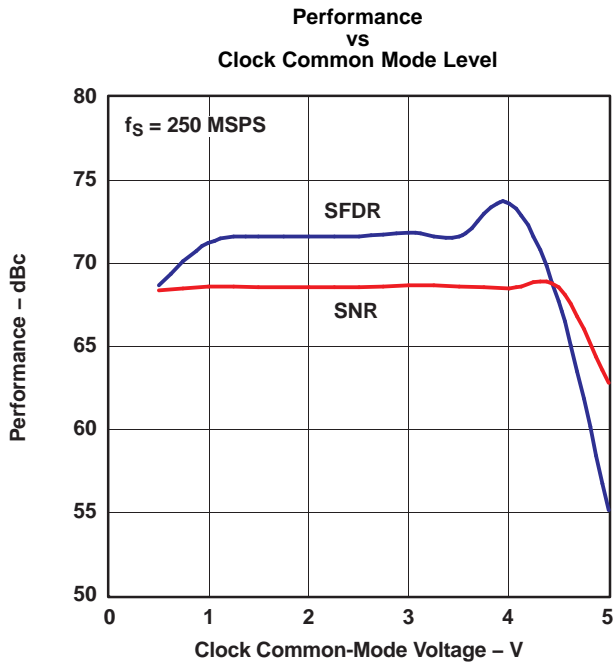

Figure 27.

G027

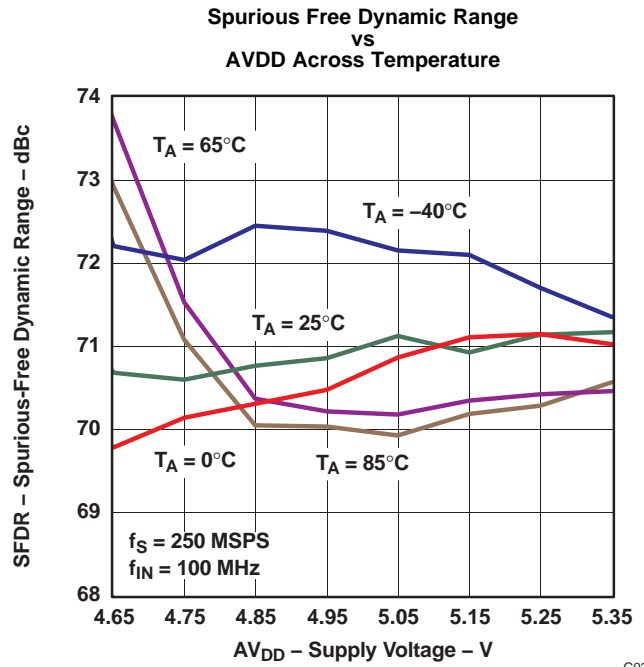

Figure 28.

G028

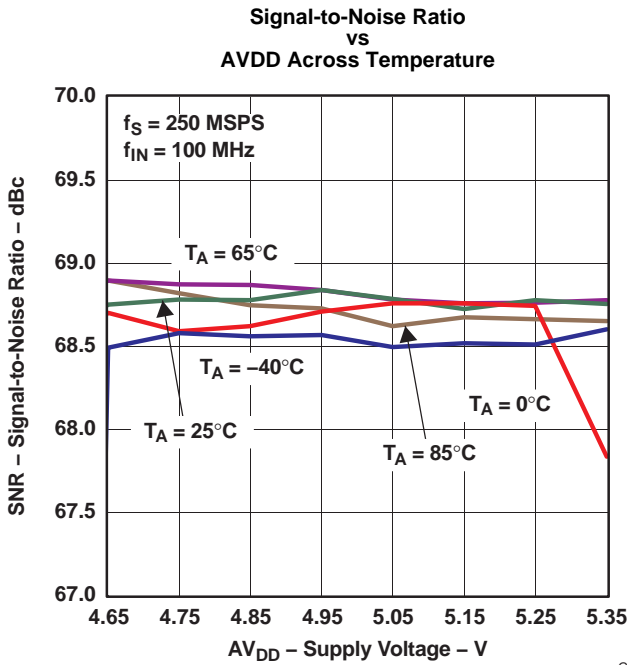

Figure 29.

G029

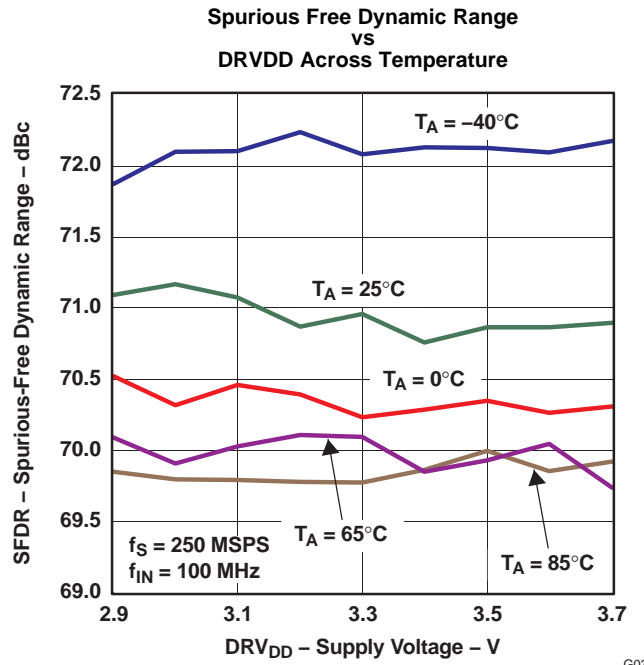

Figure 30.

G030

TYPICAL CHARACTERISTICS (continued)

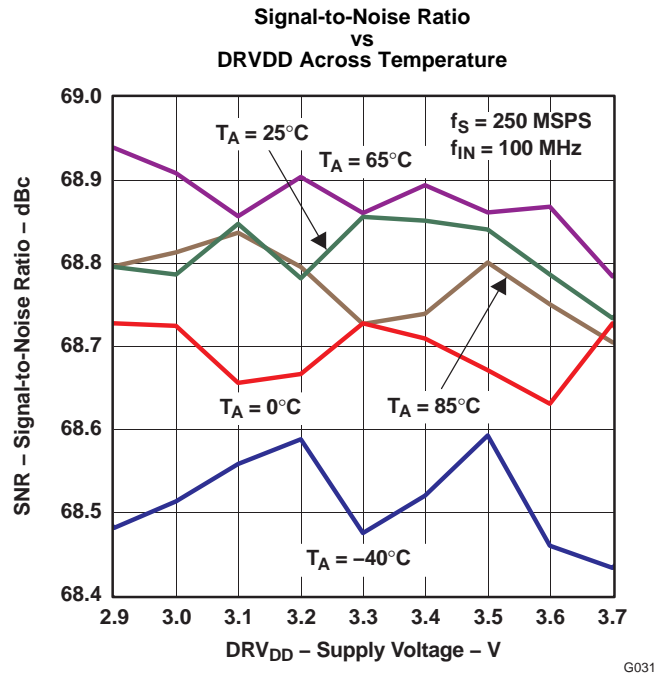

Figure 31.

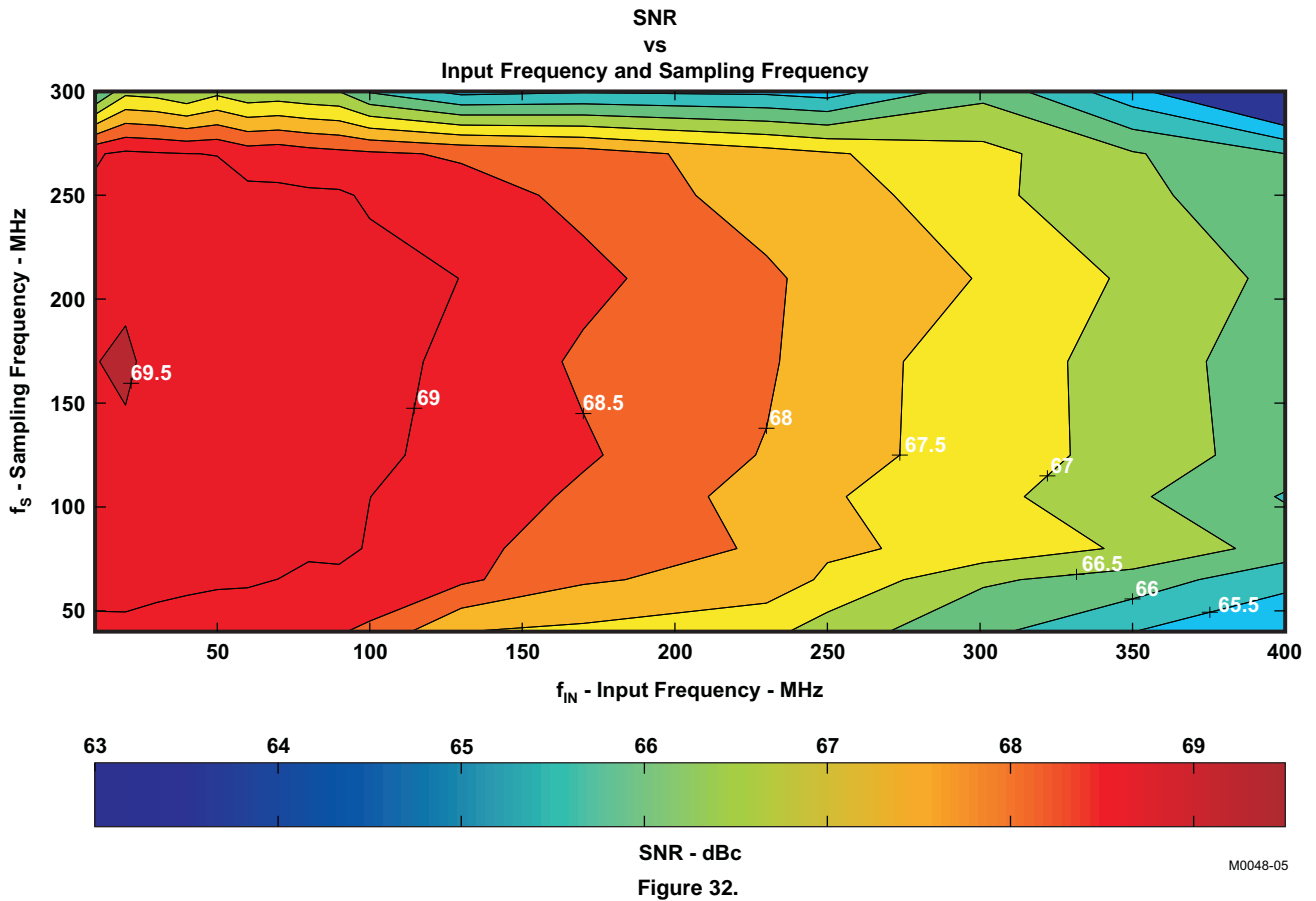
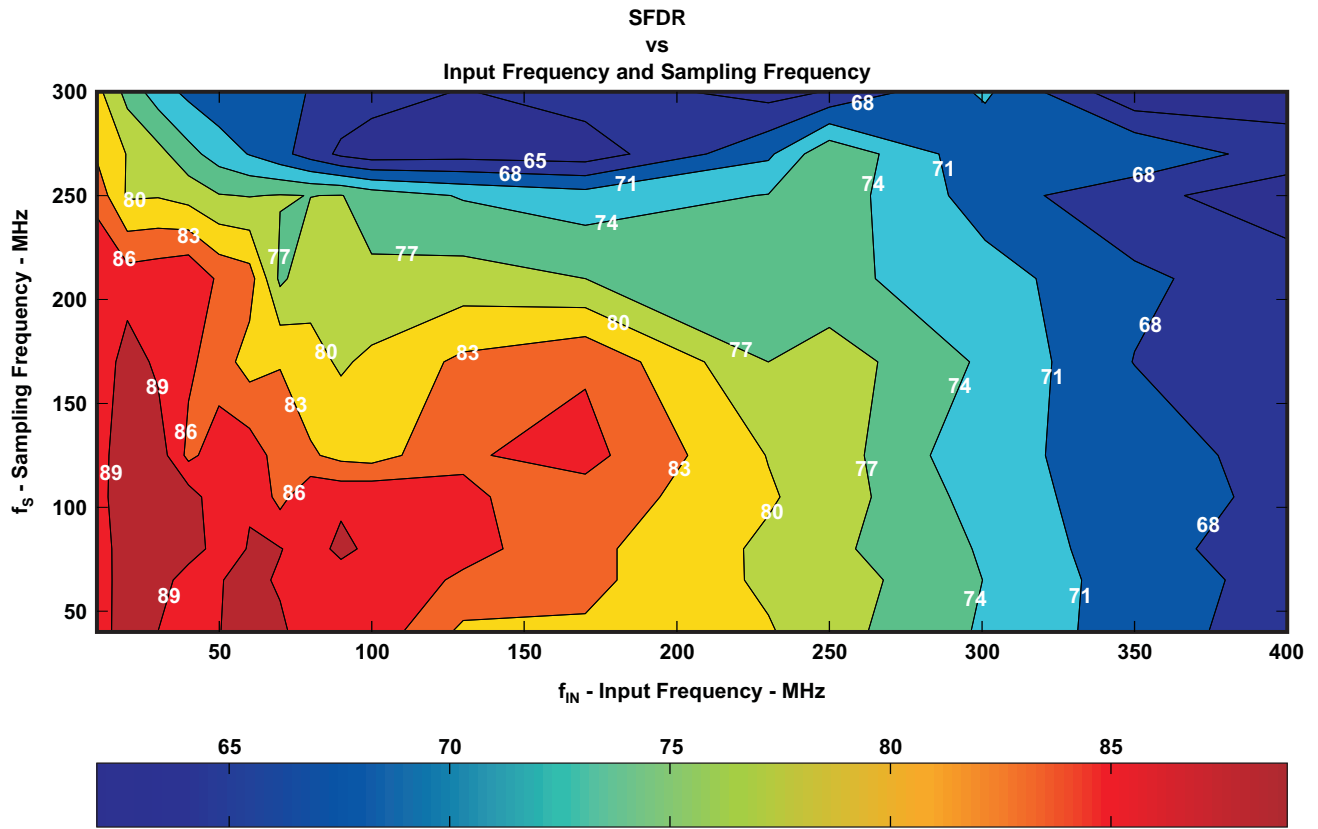

Figure 32.

TYPICAL CHARACTERISTICS (continued)



SFDR - dBc  
Figure 33.

M0048-06

## APPLICATION INFORMATION

### Theory of Operation

The ADS5444 is a 13-bit, 250-MSPS, monolithic pipeline analog-to-digital converter (ADC). Its bipolar analog core operates from a 5 V supply, while the output uses a 3.3-V supply to provide LVDS compatible outputs. The conversion process is initiated by the rising edge of the external input clock. At that instant, the differential input signal is captured by the input track and hold (T&H) and the input sample is sequentially converted by a series of small resolution stages, with the outputs combined in a digital correction logic block. Both the rising and the falling clock edges are used to propagate the sample through the pipeline every half clock cycle. This process results in a data latency of four clock cycles, after which the output data is available as a 13-bit parallel word, coded in offset binary format.

### Input Configuration

The analog input for the ADS5444 consists of an analog differential buffer followed by a bipolar T&H. The analog buffer isolates the source driving the input of the ADC from any internal switching. The input common mode is set internally through a 500- $\Omega$  resistor connected from 2.4 V to each of the inputs. This results in a differential input impedance of 1 k $\Omega$ .

For a full-scale differential input, each of the differential lines of the input signal (pins 16 and 17) swings symmetrically between  $2.4 + 0.55$  V and  $2.4 - 0.55$  V. This means that each input has a maximum signal swing of 1.1 V<sub>PP</sub> for a total differential input signal swing of 2.2 V<sub>PP</sub>. The maximum swing is determined by the internal reference voltage generator eliminating the need for any external circuitry for this purpose.

The ADS5444 obtains optimum performance when the analog inputs are driven differentially. The circuit in Figure 34 shows one possible configuration using an RF transformer with termination either on the primary or on the secondary of the transformer. If voltage gain is required, a step up transformer can be used. For voltage gains that would require an impractical transformer turn ratio, a single-ended amplifier driving the transformer is shown in Figure 35).

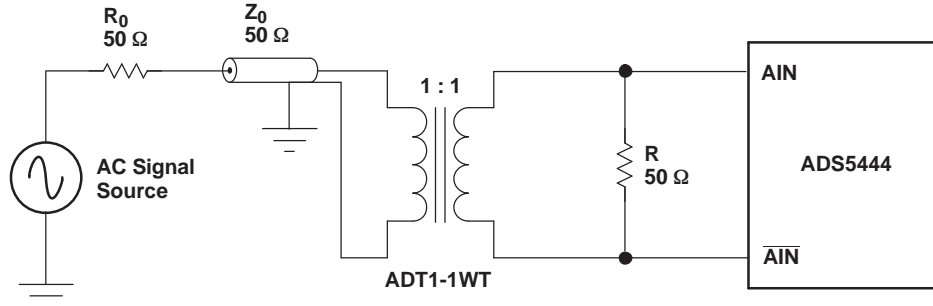

Figure 34. Converting a Single-Ended Input to a Differential Signal Using RF Transformers

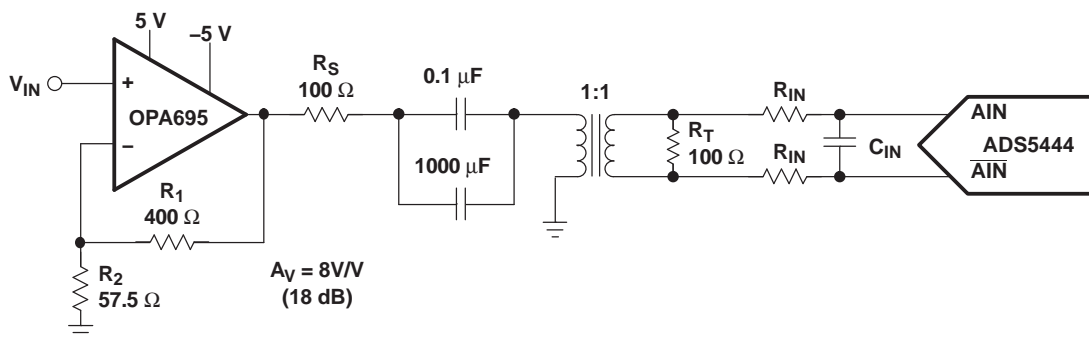

Figure 35. Using the OPA695 With the ADS5444

Application Information (continued)

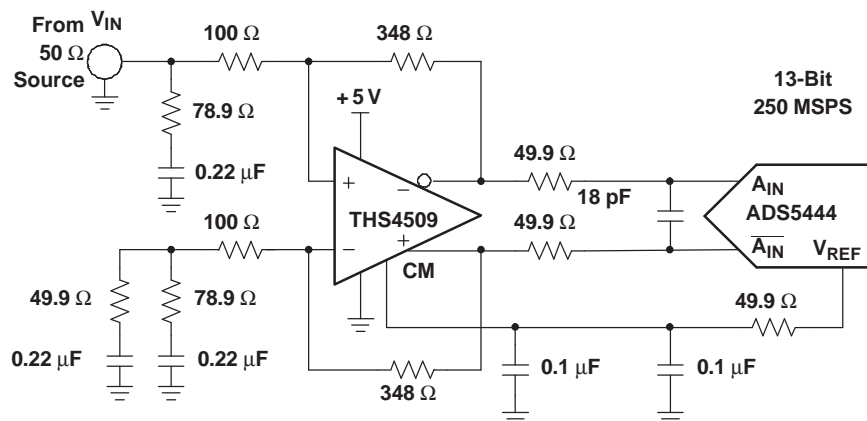

Figure 36. Using the THS4509 With the ADS5444

Besides the OPA695, TI offers a wide selection of single-ended operational amplifiers that can be selected depending on the application. An RF gain block amplifier, such as the TI THS9001, can also be used with an RF transformer for high input frequency applications. For applications requiring dc-coupling with the signal source, a differential input/differential output amplifier like the THS4509 (see Figure 36) is a good solution, as it minimizes board space and reduces the number of components.

In this configuration, the THS4509 amplifier circuit provides 10 dB of gain, converts the single-ended input to differential, and sets the proper input common-mode voltage to the ADS5444.

The 50-Ω resistors and 18-pF capacitor between the THS4509 outputs and ADS5444 inputs (along with the input capacitance of the ADC) limit the bandwidth of the signal to about 70 MHz (–3 dB).

Input termination is accomplished via the 78.9-Ω resistor and 0.22-μF capacitor to ground in conjunction with the input impedance of the amplifier circuit. A 0.22-μF capacitor and 49.9-Ω resistor is inserted to ground across the 78.9-Ω resistor and 0.22-μF capacitor on the alternate input to balance the circuit.

Gain is a function of the source impedance, termination, and 348-Ω feedback resistor. See the THS4509 data sheet for further component values to set proper 50-Ω termination for other common gains.

Since the ADS5444 recommended input common-mode voltage is 2.4 V, the THS4509 is operated from a single power supply input with  $V_{S+} = 5\text{ V}$  and  $V_{S-} = 0\text{ V}$  (ground). This maintains maximum headroom on the internal transistors of the THS4509.

**Clock Inputs**

The ADS5444 clock input can be driven with either a differential clock signal or a single-ended clock input, with little or no difference in performance between both configurations. In low input frequency applications, where jitter may not be a big concern, the use of single-ended clock (see Figure 37) could save some cost and board space without any trade-off in performance. When driven on this configuration, it is best to connect CLK to ground with a 0.01 μF capacitor, while CLK is ac-coupled with a 0.01-μF capacitor to the clock source, as shown in Figure 37.

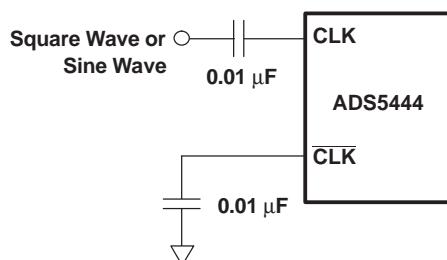
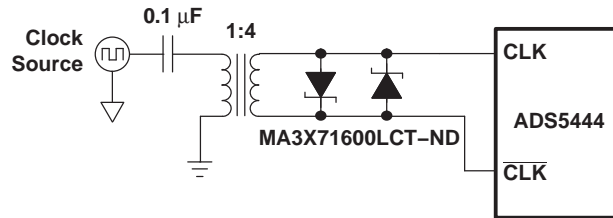

Figure 37. Single-Ended Clock

## Application Information (continued)

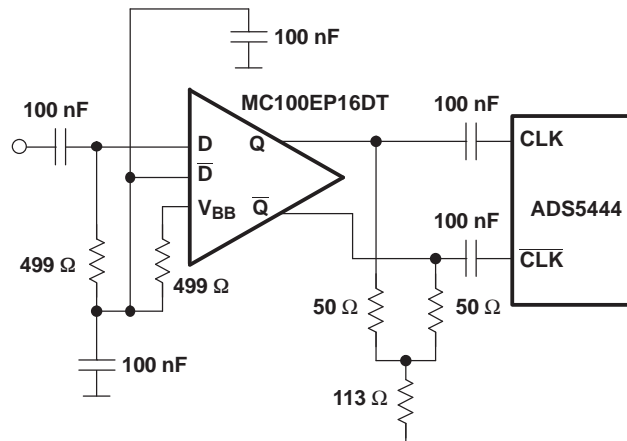

**Figure 38. Differential Clock**

For jitter-sensitive applications, the use of a differential clock has some advantages (as with any other ADC) at the system level. The first advantage is that it allows for common-mode noise rejection at the PCB level.

A differential clock also allows for the use of bigger clock amplitudes without exceeding the absolute maximum ratings. In the case of a sinusoidal clock, this results in higher slew rates and reduces the impact of clock noise on jitter. See *Clocking High Speed Data Converters (SLYT075)* for more details.

Figure 38 shows this approach. The back-to-back Schottky diodes can be added to limit the clock amplitude in cases where this would exceed the absolute maximum ratings, even when using a differential clock.



**Figure 39. Differential Clock Using PECL Logic**

Another possibility is the use of a logic based clock, such as PECL. In this case, the slew rate of the edges will most likely be much higher than the one obtained for the same clock amplitude based on a sinusoidal clock. This solution would minimize the effect of the slope dependent ADC jitter. Using logic gates to square a sinusoidal clock may not produce the best results as logic gates may not have been optimized to act as comparators, adding too much jitter while squaring the inputs.

The common-mode voltage of the clock inputs is set internally to 2.4 V using internal 1-k $\Omega$  resistors. It is recommended to use ac coupling, but if this scheme is not possible due to, for instance, asynchronous clocking, the ADS5444 features good tolerance to clock common-mode variation.

Additionally, the internal ADC core uses both edges of the clock for the conversion process. Ideally, a 50% duty cycle clock signal should be provided.

## Digital Outputs

The ADC provides 13 data outputs (D12 to D0, with D12 being the MSB and D0 the LSB), a data-ready signal (DRY), and an over-range indicator (OVR) that equals a logic high when the output reaches the full-scale limits. The output format is offset binary. It is recommended to use the DRY signal to capture the output data of the ADS5444.

The ADS5444 digital outputs are LVDS compatible.

---

## Application Information (continued)

### Power Supplies

The use of low noise power supplies with adequate decoupling is recommended. Linear supplies are the preferred choice versus switched ones, which tend to generate more noise components that can be coupled to the ADS5444.

The ADS5444 uses two power supplies. For the analog portion of the design, a 5-V AVDD is used, while for the digital outputs supply (DRVDD) we recommend the use of 3.3 V. All the ground pins are marked as GND, although AGND pins and DRGND pins are not tied together inside the package.

### Layout Information

The evaluation board represents a good guideline of how to layout the board to obtain the maximum performance out of the ADS5444. General design rules as the use of multilayer boards, single ground plane for ADC ground connections and local decoupling ceramic chip capacitors should be applied. The input traces should be isolated from any external source of interference or noise including the digital outputs, as well as the clock traces. The clock signal traces should also be isolated from other signals, especially in applications where low jitter is required as high IF sampling.

Besides performance oriented rules, care has to be taken when considering the heat dissipation out of the device. The thermal heatsink should be soldered to the board as described in the PowerPAD Package section.

### PowerPAD Package

The PowerPAD package is a thermally-enhanced standard size IC package designed to eliminate the use of bulky heatsinks and slugs traditionally used in thermal packages. This package can be easily mounted using standard printed circuit board (PCB) assembly techniques, and can be removed and replaced using standard repair procedures.

The PowerPAD package is designed so that the leadframe die pad (or thermal pad) is exposed on the bottom of the IC. This provides an extremely low thermal resistance path between the die and the exterior of the package. The thermal pad on the bottom of the IC can then be soldered directly to the PCB using the PCB as a heatsink.

### Assembly Process

1. Prepare the PCB top-side etch pattern including etch for the leads, as well as the thermal pad as illustrated in the Mechanical Data section.
2. Place a 6-by-6 array of thermal vias in the thermal pad area. These holes should be 13 mils in diameter. The small size prevents wicking of the solder through the holes.
3. It is recommended to place a small number of 25-mil diameter holes under the package, but outside the thermal pad area to provide an additional heat path.
4. Connect all holes (both those inside and outside the thermal pad area) to an internal copper plane (such as a ground plane).
5. Do not use the typical web or spoke via connection pattern when connecting the thermal vias to the ground plane. The spoke pattern increases the thermal resistance to the ground plane.
6. The top-side solder mask should leave exposed the terminals of the package and the thermal pad area.
7. Cover the entire bottom side of the PowerPAD vias to prevent solder wicking.
8. Apply solder paste to the exposed thermal pad area and all of the package terminals.

For more detailed information regarding the PowerPAD package and its thermal properties, see either the [SLMA004](#) application brief, *PowerPAD Made Easy*, or the technical brief, *PowerPAD Thermally Enhanced Package (SLMA002)*.



**PACKAGING INFORMATION**

Orderable Device	Status <sup>(1)</sup>	Package Type	Package Drawing	Pins	Package Qty	Eco Plan <sup>(2)</sup>	Lead/Ball Finish	MSL Peak Temp <sup>(3)</sup>
ADS5444MPFPEP	ACTIVE	HTQFP	PFP	80	96	Green (RoHS & no Sb/Br)	CU NIPDAU	Level-3-260C-168 HR
V62/06668-01XE	ACTIVE	HTQFP	PFP	80	96	Green (RoHS & no Sb/Br)	CU NIPDAU	Level-3-260C-168 HR

<sup>(1)</sup> The marketing status values are defined as follows:

**ACTIVE:** Product device recommended for new designs.

**LIFEBUY:** TI has announced that the device will be discontinued, and a lifetime-buy period is in effect.

**NRND:** Not recommended for new designs. Device is in production to support existing customers, but TI does not recommend using this part in a new design.

**PREVIEW:** Device has been announced but is not in production. Samples may or may not be available.

**OBsolete:** TI has discontinued the production of the device.

<sup>(2)</sup> Eco Plan - The planned eco-friendly classification: Pb-Free (RoHS), Pb-Free (RoHS Exempt), or Green (RoHS & no Sb/Br) - please check <http://www.ti.com/productcontent> for the latest availability information and additional product content details.

**TBD:** The Pb-Free/Green conversion plan has not been defined.

**Pb-Free (RoHS):** TI's terms "Lead-Free" or "Pb-Free" mean semiconductor products that are compatible with the current RoHS requirements for all 6 substances, including the requirement that lead not exceed 0.1% by weight in homogeneous materials. Where designed to be soldered at high temperatures, TI Pb-Free products are suitable for use in specified lead-free processes.

**Pb-Free (RoHS Exempt):** This component has a RoHS exemption for either 1) lead-based flip-chip solder bumps used between the die and package, or 2) lead-based die adhesive used between the die and leadframe. The component is otherwise considered Pb-Free (RoHS compatible) as defined above.

**Green (RoHS & no Sb/Br):** TI defines "Green" to mean Pb-Free (RoHS compatible), and free of Bromine (Br) and Antimony (Sb) based flame retardants (Br or Sb do not exceed 0.1% by weight in homogeneous material)

<sup>(3)</sup> MSL, Peak Temp. -- The Moisture Sensitivity Level rating according to the JEDEC industry standard classifications, and peak solder temperature.

**Important Information and Disclaimer:**The information provided on this page represents TI's knowledge and belief as of the date that it is provided. TI bases its knowledge and belief on information provided by third parties, and makes no representation or warranty as to the accuracy of such information. Efforts are underway to better integrate information from third parties. TI has taken and continues to take reasonable steps to provide representative and accurate information but may not have conducted destructive testing or chemical analysis on incoming materials and chemicals. TI and TI suppliers consider certain information to be proprietary, and thus CAS numbers and other limited information may not be available for release.

In no event shall TI's liability arising out of such information exceed the total purchase price of the TI part(s) at issue in this document sold by TI to Customer on an annual basis.

**OTHER QUALIFIED VERSIONS OF ADS5444-EP :**

- Catalog: [ADS5444](#)
- Space: [ADS5444-SP](#)

NOTE: Qualified Version Definitions:

- Catalog - TI's standard catalog product
- Space - Radiation tolerant, ceramic packaging and qualified for use in Space-based application

PFP (S-PQFP-G80)

PowerPAD™ PLASTIC QUAD FLATPACK

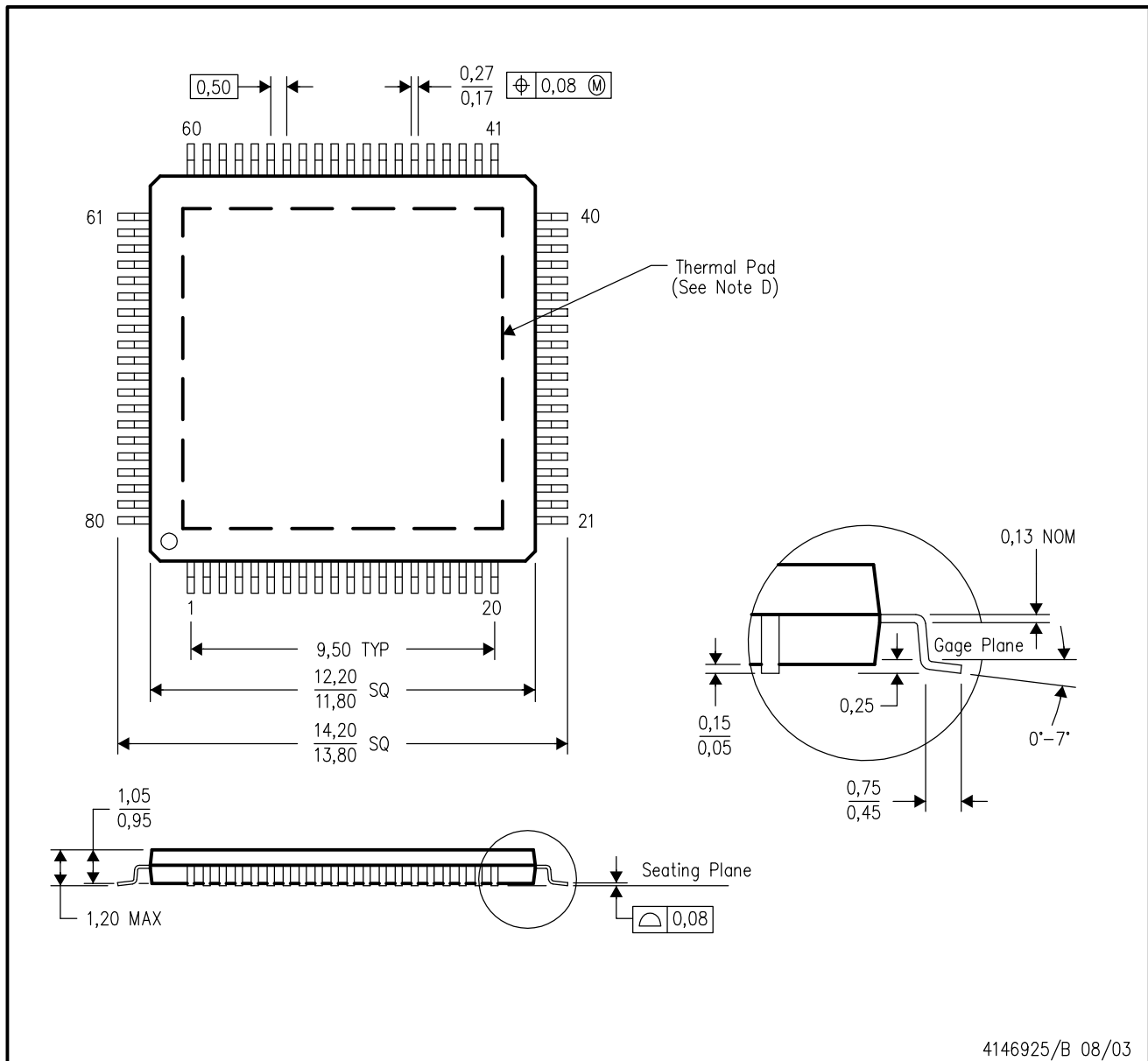

- NOTES:
- All linear dimensions are in millimeters.
  - This drawing is subject to change without notice.
  - Body dimensions do not include mold flash or protrusion.
  - This package is designed to be soldered to a thermal pad on the board. Refer to Technical Brief, PowerPad Thermally Enhanced Package, Texas Instruments Literature No. SLMA002 for information regarding recommended board layout. This document is available at [www.ti.com](http://www.ti.com) <<http://www.ti.com>>.
  - Falls within JEDEC MS-026

PowerPAD is a trademark of Texas Instruments.

## THERMAL PAD MECHANICAL DATA

PFP (S-PQFP-G80)

PowerPAD™ PLASTIC QUAD FLATPACK

### THERMAL INFORMATION

This PowerPAD™ package incorporates an exposed thermal pad that is designed to be attached to a printed circuit board (PCB). The thermal pad must be soldered directly to the PCB. After soldering, the PCB can be used as a heatsink. In addition, through the use of thermal vias, the thermal pad can be attached directly to the appropriate copper plane shown in the electrical schematic for the device, or alternatively, can be attached to a special heatsink structure designed into the PCB. This design optimizes the heat transfer from the integrated circuit (IC).

For additional information on the PowerPAD package and how to take advantage of its heat dissipating abilities, refer to Technical Brief, PowerPAD Thermally Enhanced Package, Texas Instruments Literature No. SLMA002 and Application Brief, PowerPAD Made Easy, Texas Instruments Literature No. SLMA004. Both documents are available at [www.ti.com](http://www.ti.com).

The exposed thermal pad dimensions for this package are shown in the following illustration.

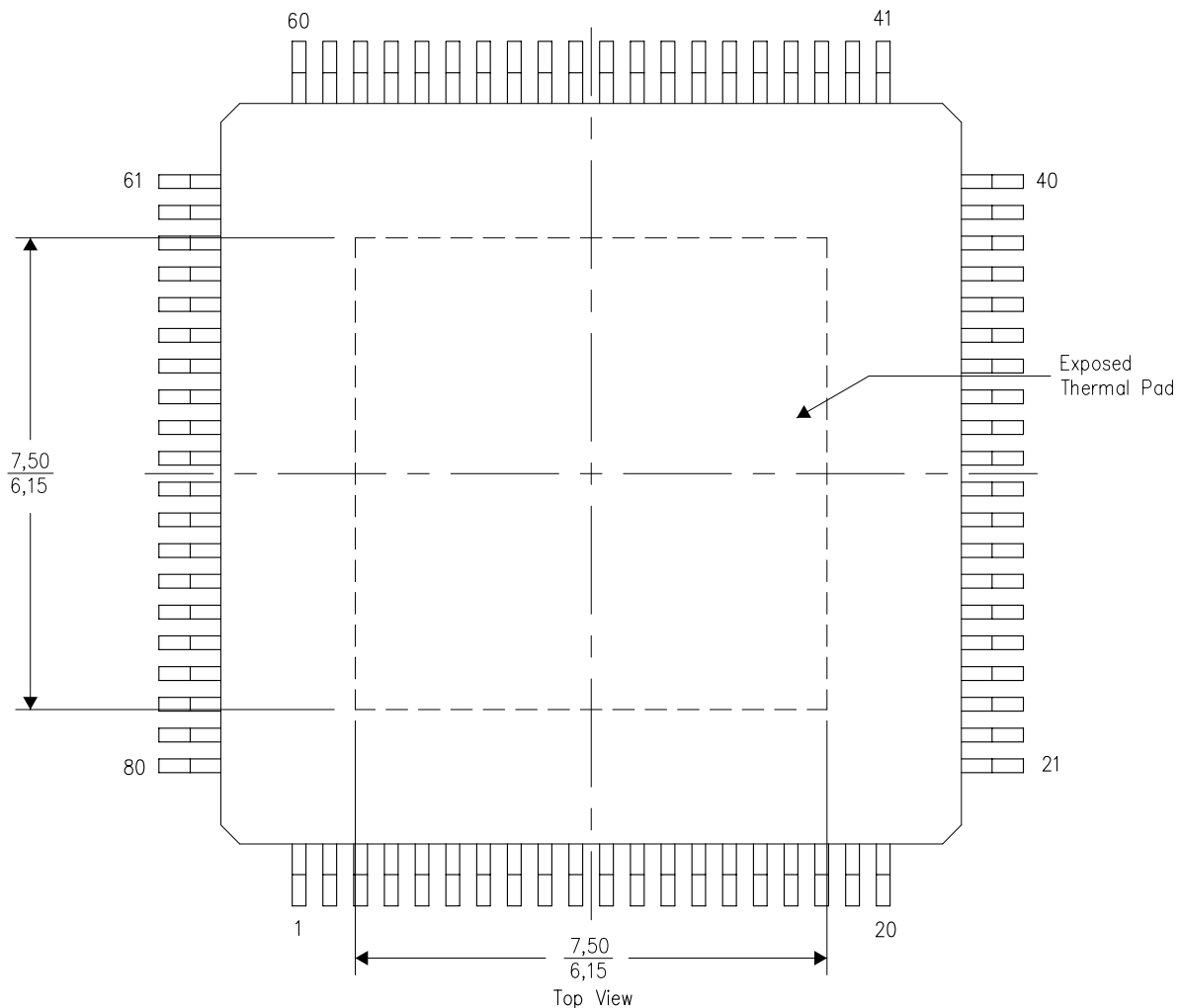

4206327-2/L 10/10

NOTE: A. All linear dimensions are in millimeters

PowerPAD is a trademark of Texas Instruments

PFP (S-PQFP-G80)

PowerPAD™ PLASTIC QUAD FLATPACK

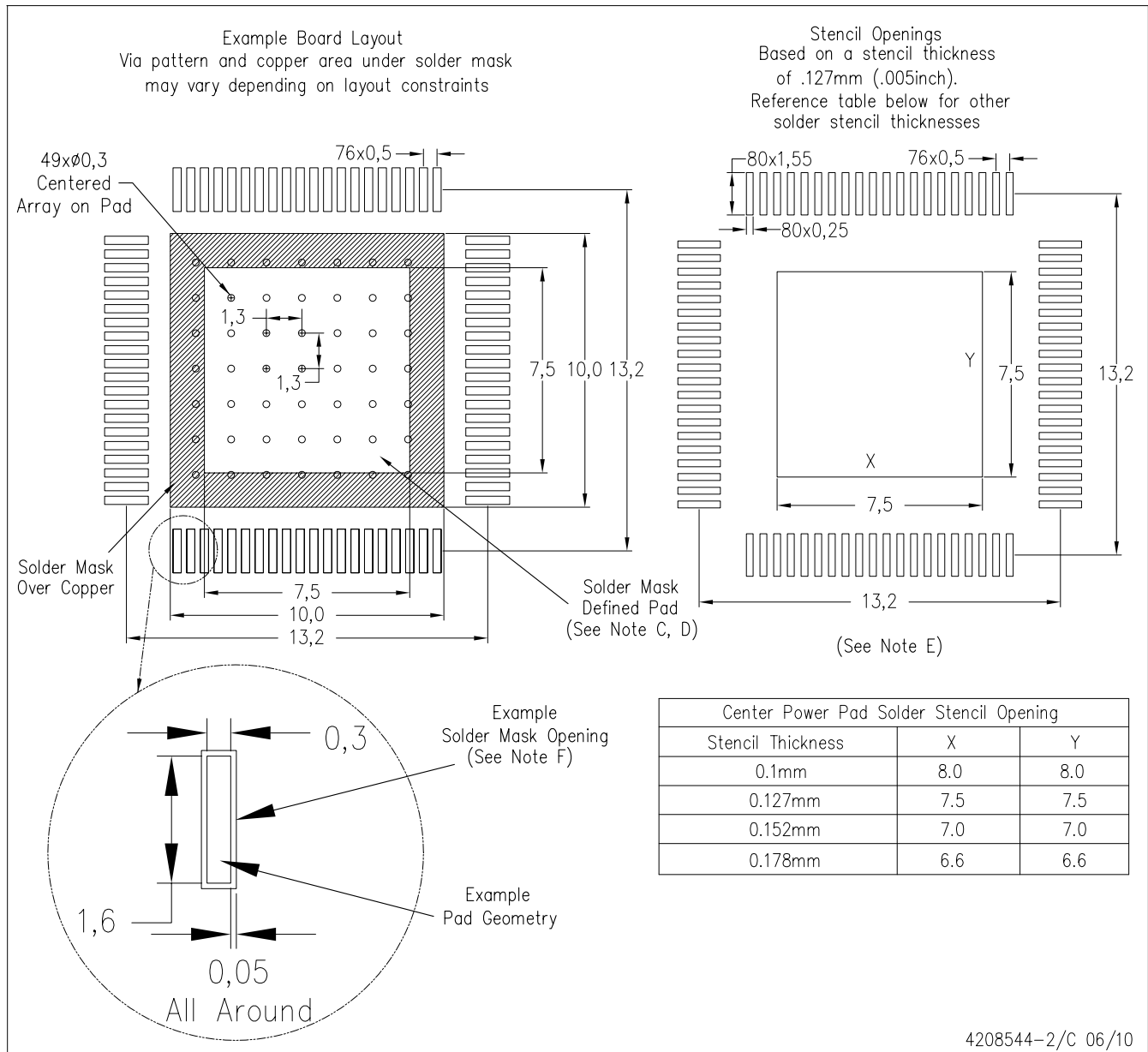

4208544-2/C 06/10

- NOTES:
- All linear dimensions are in millimeters.
  - This drawing is subject to change without notice.
  - Customers should place a note on the circuit board fabrication drawing not to alter the center solder mask defined pad.
  - This package is designed to be soldered to a thermal pad on the board. Refer to Technical Brief, PowerPAD Thermally Enhanced Package, Texas Instruments Literature No. SLMA002, SLMA004, and also the Product Data Sheets for specific thermal information, via requirements, and recommended board layout. These documents are available at [www.ti.com](http://www.ti.com) <<http://www.ti.com>>. Publication IPC-7351 is recommended for alternate designs.
  - Laser cutting apertures with trapezoidal walls and also rounding corners will offer better paste release. Customers should contact their board assembly site for stencil design recommendations. Example stencil design based on a 50% volumetric metal load solder paste. Refer to IPC-7525 for other stencil recommendations.
  - Customers should contact their board fabrication site for solder mask tolerances between and around signal pads.

PowerPAD is a trademark of Texas Instruments.

## IMPORTANT NOTICE

Texas Instruments Incorporated and its subsidiaries (TI) reserve the right to make corrections, modifications, enhancements, improvements, and other changes to its products and services at any time and to discontinue any product or service without notice. Customers should obtain the latest relevant information before placing orders and should verify that such information is current and complete. All products are sold subject to TI's terms and conditions of sale supplied at the time of order acknowledgment.

TI warrants performance of its hardware products to the specifications applicable at the time of sale in accordance with TI's standard warranty. Testing and other quality control techniques are used to the extent TI deems necessary to support this warranty. Except where mandated by government requirements, testing of all parameters of each product is not necessarily performed.

TI assumes no liability for applications assistance or customer product design. Customers are responsible for their products and applications using TI components. To minimize the risks associated with customer products and applications, customers should provide adequate design and operating safeguards.

TI does not warrant or represent that any license, either express or implied, is granted under any TI patent right, copyright, mask work right, or other TI intellectual property right relating to any combination, machine, or process in which TI products or services are used. Information published by TI regarding third-party products or services does not constitute a license from TI to use such products or services or a warranty or endorsement thereof. Use of such information may require a license from a third party under the patents or other intellectual property of the third party, or a license from TI under the patents or other intellectual property of TI.

Reproduction of TI information in TI data books or data sheets is permissible only if reproduction is without alteration and is accompanied by all associated warranties, conditions, limitations, and notices. Reproduction of this information with alteration is an unfair and deceptive business practice. TI is not responsible or liable for such altered documentation. Information of third parties may be subject to additional restrictions.

Resale of TI products or services with statements different from or beyond the parameters stated by TI for that product or service voids all express and any implied warranties for the associated TI product or service and is an unfair and deceptive business practice. TI is not responsible or liable for any such statements.

TI products are not authorized for use in safety-critical applications (such as life support) where a failure of the TI product would reasonably be expected to cause severe personal injury or death, unless officers of the parties have executed an agreement specifically governing such use. Buyers represent that they have all necessary expertise in the safety and regulatory ramifications of their applications, and acknowledge and agree that they are solely responsible for all legal, regulatory and safety-related requirements concerning their products and any use of TI products in such safety-critical applications, notwithstanding any applications-related information or support that may be provided by TI. Further, Buyers must fully indemnify TI and its representatives against any damages arising out of the use of TI products in such safety-critical applications.

TI products are neither designed nor intended for use in military/aerospace applications or environments unless the TI products are specifically designated by TI as military-grade or "enhanced plastic." Only products designated by TI as military-grade meet military specifications. Buyers acknowledge and agree that any such use of TI products which TI has not designated as military-grade is solely at the Buyer's risk, and that they are solely responsible for compliance with all legal and regulatory requirements in connection with such use.

TI products are neither designed nor intended for use in automotive applications or environments unless the specific TI products are designated by TI as compliant with ISO/TS 16949 requirements. Buyers acknowledge and agree that, if they use any non-designated products in automotive applications, TI will not be responsible for any failure to meet such requirements.

Following are URLs where you can obtain information on other Texas Instruments products and application solutions:

<b>Products</b>		<b>Applications</b>	
Amplifiers	<a href="http://amplifier.ti.com">amplifier.ti.com</a>	Audio	<a href="http://www.ti.com/audio">www.ti.com/audio</a>
Data Converters	<a href="http://dataconverter.ti.com">dataconverter.ti.com</a>	Automotive	<a href="http://www.ti.com/automotive">www.ti.com/automotive</a>
DLP® Products	<a href="http://www.dlp.com">www.dlp.com</a>	Communications and Telecom	<a href="http://www.ti.com/communications">www.ti.com/communications</a>
DSP	<a href="http://dsp.ti.com">dsp.ti.com</a>	Computers and Peripherals	<a href="http://www.ti.com/computers">www.ti.com/computers</a>
Clocks and Timers	<a href="http://www.ti.com/clocks">www.ti.com/clocks</a>	Consumer Electronics	<a href="http://www.ti.com/consumer-apps">www.ti.com/consumer-apps</a>
Interface	<a href="http://interface.ti.com">interface.ti.com</a>	Energy	<a href="http://www.ti.com/energy">www.ti.com/energy</a>
Logic	<a href="http://logic.ti.com">logic.ti.com</a>	Industrial	<a href="http://www.ti.com/industrial">www.ti.com/industrial</a>
Power Mgmt	<a href="http://power.ti.com">power.ti.com</a>	Medical	<a href="http://www.ti.com/medical">www.ti.com/medical</a>
Microcontrollers	<a href="http://microcontroller.ti.com">microcontroller.ti.com</a>	Security	<a href="http://www.ti.com/security">www.ti.com/security</a>
RFID	<a href="http://www.ti-rfid.com">www.ti-rfid.com</a>	Space, Avionics & Defense	<a href="http://www.ti.com/space-avionics-defense">www.ti.com/space-avionics-defense</a>
RF/IF and ZigBee® Solutions	<a href="http://www.ti.com/lprf">www.ti.com/lprf</a>	Video and Imaging	<a href="http://www.ti.com/video">www.ti.com/video</a>
		Wireless	<a href="http://www.ti.com/wireless-apps">www.ti.com/wireless-apps</a>