

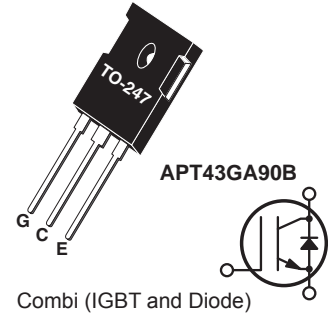

## High Speed PT IGBT

POWER MOS 8® is a high speed Punch-Through switch-mode IGBT. Low  $E_{off}$  is achieved through leading technology silicon design and lifetime control processes. A reduced  $E_{off} - V_{CE(ON)}$  tradeoff results in superior efficiency compared to other IGBT technologies. Low gate charge and a greatly reduced ratio of  $C_{res}/C_{ies}$  provide excellent noise immunity, short delay times and simple gate drive. The intrinsic chip gate resistance and capacitance of the poly-silicone gate structure help control di/dt during switching, resulting in low EMI, even when switching at high frequency.



### FEATURES

- Fast switching with low EMI
- Very Low  $E_{off}$  for maximum efficiency
- Ultra low  $C_{res}$  for improved noise immunity
- Low conduction loss
- Low gate charge
- Increased intrinsic gate resistance for low EMI
- RoHS compliant 

### TYPICAL APPLICATIONS

- ZVS phase shifted and other full bridge
- Half bridge
- High power PFC boost
- Welding
- UPS, solar, and other inverters
- High frequency, high efficiency industrial

### Absolute Maximum Ratings

| Symbol         | Parameter   | Ratings     | Unit |
|----------------|---|-------------|------|
| $V_{CES}$      | Collector Emitter Voltage                                       | 900         | V    |
| $I_{C1}$       | Continuous Collector Current @ $T_c = 25^\circ\text{C}$         | 78          | A    |
| $I_{C2}$       | Continuous Collector Current @ $T_c = 100^\circ\text{C}$        | 43          |      |
| $I_{CM}$       | Pulsed Collector Current <sup>1</sup>                           | 129         |      |
| $V_{GE}$       | Gate-Emitter Voltage <sup>2</sup>                               | $\pm 30$    | V    |
| $P_D$          | Total Power Dissipation @ $T_c = 25^\circ\text{C}$              | 337         | W    |
| SSOA           | Switching Safe Operating Area @ $T_j = 150^\circ\text{C}$       | 129A @ 900V |      |
| $T_J, T_{STG}$ | Operating and Storage Junction Temperature Range                | -55 to 150  | °C   |
| $T_L$          | Lead Temperature for Soldering: 0.063" from Case for 10 Seconds | 300         |      |

### Static Characteristics

$T_J = 25^\circ\text{C}$  unless otherwise specified

| Symbol        | Parameter                           | Test Conditions   | Min | Typ        | Max         | Unit |
|---------------|-------------------------------------|---|-----|------------|-------------|------|
| $V_{BR(CES)}$ | Collector-Emitter Breakdown Voltage | $V_{GE} = 0V, I_C = 1.0mA$  | 900 |            |             | V    |
| $V_{CE(on)}$  | Collector-Emitter On Voltage        | $V_{GE} = 15V, I_C = 47A$<br>$T_J = 25^\circ\text{C}$<br>$T_J = 125^\circ\text{C}$    |     | 2.5<br>2.2 | 3.1         |      |
| $V_{GE(th)}$  | Gate Emitter Threshold Voltage      | $V_{GE} = V_{CE}, I_C = 1mA$  | 3   | 4.5        | 6           | µA   |
| $I_{CES}$     | Zero Gate Voltage Collector Current | $V_{CE} = 900V, V_{GE} = 0V$<br>$T_J = 25^\circ\text{C}$<br>$T_J = 125^\circ\text{C}$ |     |            | 350<br>1500 |      |
| $I_{GES}$     | Gate-Emitter Leakage Current        | $V_{GS} = \pm 30V$  |     |            | $\pm 100$   | nA   |

### Thermal and Mechanical Characteristics

| Symbol          | Characteristic                                     | Min | Typ | Max  | Unit   |
|-----------------|--|-----|-----|------|--------|
| $R_{\theta JC}$ | Junction to Case Thermal Resistance (IGBT)         | -   | -   | 0.37 | °C/W   |
| $R_{\theta JC}$ | Junction to Case Thermal Resistance (Diode)        | -   | -   | 0.80 |        |
| $W_T$           | Package Weight                                     | -   | 5.9 | -    | g      |
| Torque          | Mounting Torque (TO-247 Package), 4-40 or M3 screw |     |     | 10   | in-lbf |

Dynamic Characteristics

T<sub>J</sub> = 25°C unless otherwise specified

APT43GA90BD30

| Symbol                        | Parameter                     | Test Conditions   | Min | Typ  | Max  | Unit |    |
|-------------------------------|-------------------------------|---|-----|------|------|------|----|
| C <sub>ies</sub>              | Input Capacitance             | Capacitance<br>V <sub>GE</sub> = 0V, V <sub>CE</sub> = 25V<br>f = 1MHz  |     | 2465 |      | pF   |    |
| C <sub>oes</sub>              | Output Capacitance            |   |     | 227  |      |      |    |
| C <sub>res</sub>              | Reverse Transfer Capacitance  |   |     | 34   |      |      |    |
| Q <sub>g</sub> <sup>2</sup>   | Total Gate Charge             | Gate Charge<br>V <sub>GE</sub> = 15V<br>V <sub>CE</sub> = 450V<br>I <sub>C</sub> = 25A  |     | 116  |      | nC   |    |
| Q <sub>ge</sub>               | Gate-Emitter Charge           |   |     | 18   |      |      |    |
| Q <sub>gc</sub>               | Gate- Collector Charge        |   |     | 44   |      |      |    |
| SSOA                          | Switching Safe Operating Area | T <sub>J</sub> = 150°C, R <sub>G</sub> = 4.7Ω, V <sub>GE</sub> = 15V,<br>L = 100uH, V <sub>CE</sub> = 900V  | 129 |      |      | A    |    |
| t <sub>d(on)</sub>            | Turn-On Delay Time            | Inductive Switching (25°C)<br>V <sub>CC</sub> = 600V<br>V <sub>GE</sub> = 15V<br>I <sub>C</sub> = 25A<br>R <sub>G</sub> = 4.7Ω <sup>3</sup><br>T <sub>J</sub> = +25°C   |     | 12   |      | ns   |    |
| t <sub>r</sub>                | Current Rise Time             |   |     | 16   |      |      |    |
| t <sub>d(off)</sub>           | Turn-Off Delay Time           |   |     | 82   |      |      |    |
| t <sub>f</sub>                | Current Fall Time             |   |     | 57   |      |      |    |
| E <sub>on2</sub>              | Turn-On Switching Energy      |   |     |      | 875  |      | μJ |
| E <sub>off</sub> <sup>5</sup> | Turn-Off Switching Energy     |   |     |      | 425  |      |    |
| t <sub>d(on)</sub>            | Turn-On Delay Time            | Inductive Switching (125°C)<br>V <sub>CC</sub> = 600V<br>V <sub>GE</sub> = 15V<br>I <sub>C</sub> = 25A<br>R <sub>G</sub> = 4.7Ω <sup>3</sup><br>T <sub>J</sub> = +125°C |     | 12   |      | ns   |    |
| t <sub>r</sub>                | Current Rise Time             |   |     | 16   |      |      |    |
| t <sub>d(off)</sub>           | Turn-Off Delay Time           |   |     | 117  |      |      |    |
| t <sub>f</sub>                | Current Fall Time             |   |     | 129  |      |      |    |
| E <sub>on2</sub>              | Turn-On Switching Energy      |   |     |      | 1660 |      | μJ |
| E <sub>off</sub> <sup>5</sup> | Turn-Off Switching Energy     |   |     |      | 1000 |      |    |

1 Repetitive Rating: Pulse width and case temperature limited by maximum junction temperature.

2 Pulse test: Pulse Width < 380μs, duty cycle < 2%. See Mil-Std-750 Method 3471

3 R<sub>G</sub> is external gate resistance, not including internal gate resistance or gate driver impedance. (MIC4452)

4 E<sub>on1</sub> is the inductive turn-on energy of the IGBT only, without the effect of a commutating diode reverse recovery current adding to the IGBT turn-on switching loss. It is measured by clamping the inductance with a silicon carbide Schottky diode.

5 E<sub>off</sub> is the clamped inductive turn-off energy measured in accordance with JEDEC standard JESD24-1.

Microsemi reserves the right to change, without notice, the specifications and information contained herein.

# Typical Performance Curves

APT43GA90BD30

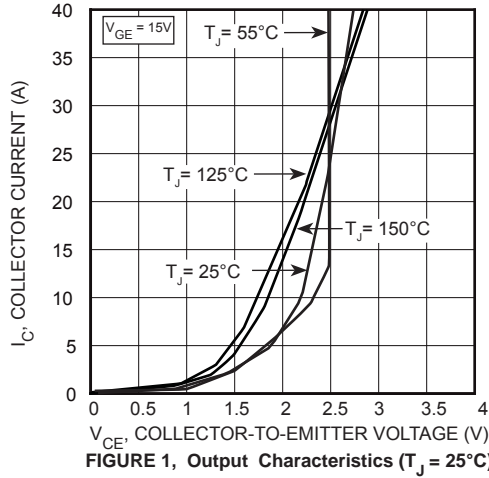

FIGURE 1, Output Characteristics ( $T_J = 25^\circ\text{C}$ )

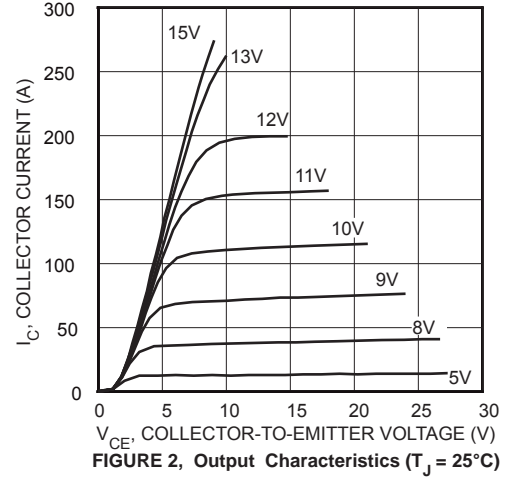

FIGURE 2, Output Characteristics ( $T_J = 25^\circ\text{C}$ )

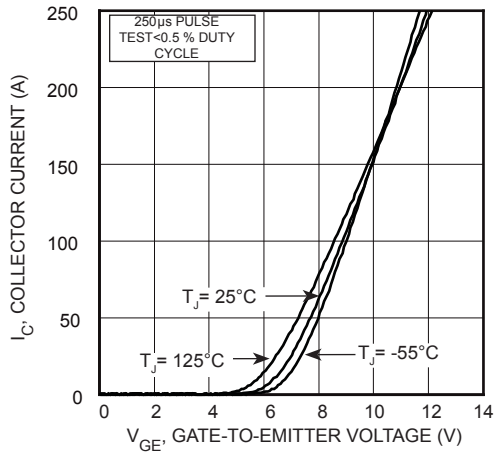

FIGURE 3, Transfer Characteristics

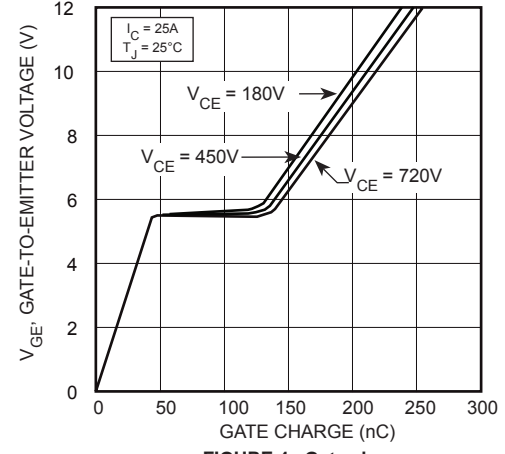

FIGURE 4, Gate charge

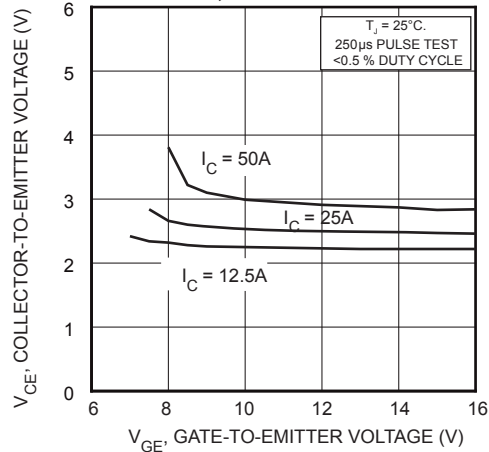

FIGURE 5, On State Voltage vs Gate-to-Emitter Voltage

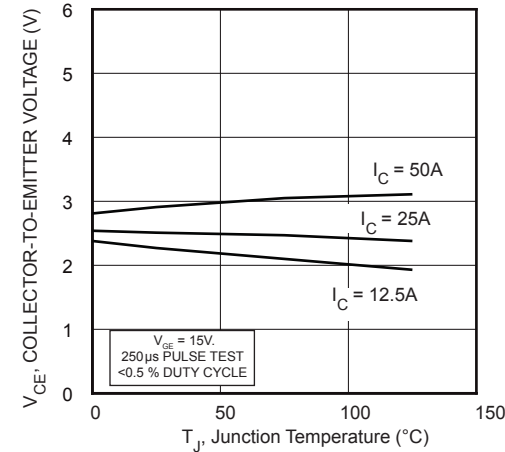

FIGURE 6, On State Voltage vs Junction Temperature

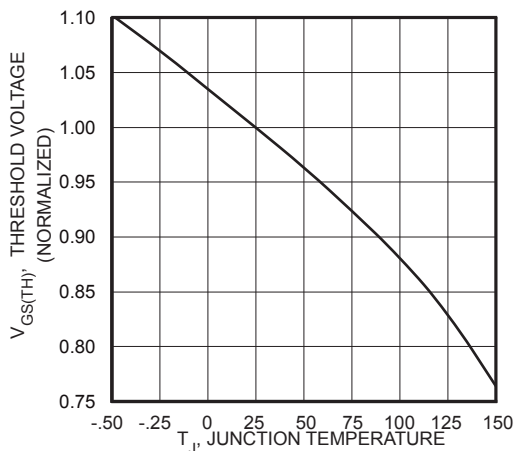

FIGURE 7, Threshold Voltage vs Junction Temperature

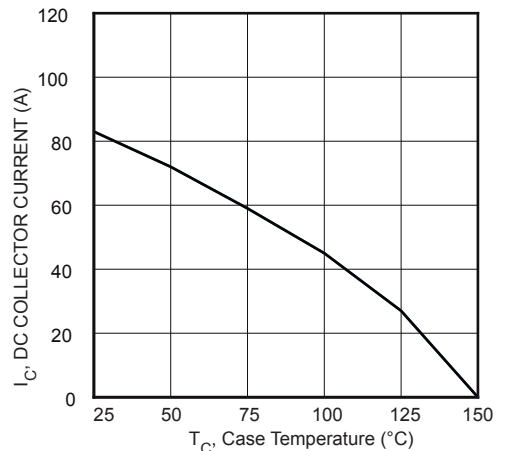

FIGURE 8, DC Collector Current vs Case Temperature

# Typical Performance Curves

APT43GA90BD30

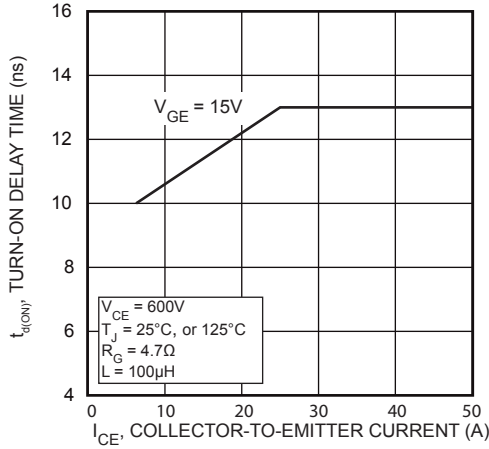

FIGURE 9, Turn-On Delay Time vs Collector Current

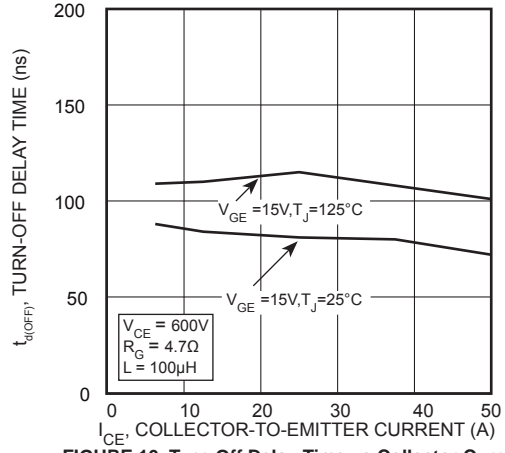

FIGURE 10, Turn-Off Delay Time vs Collector Current

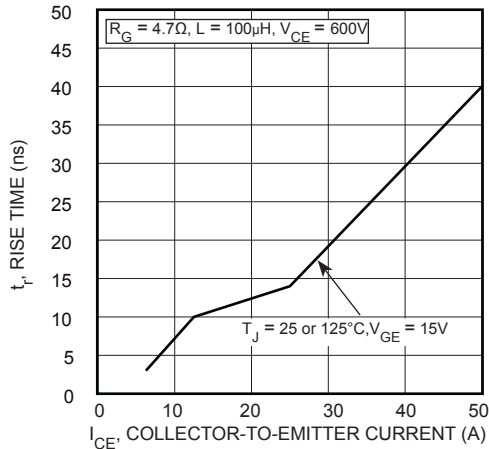

FIGURE 11, Current Rise Time vs Collector Current

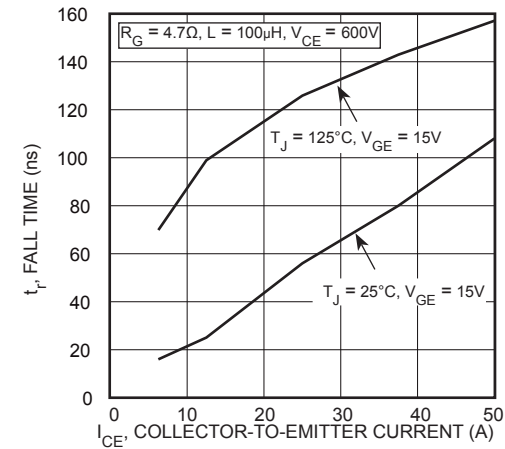

FIGURE 12, Current Fall Time vs Collector Current

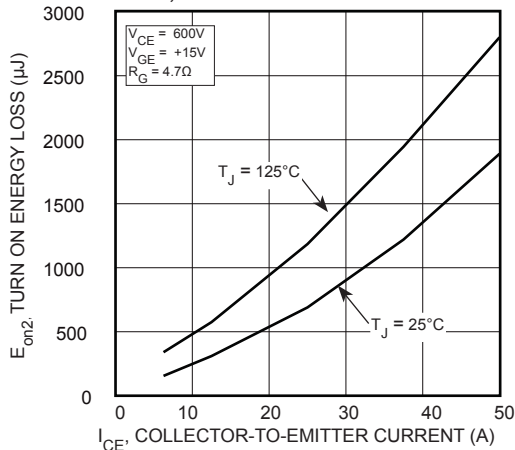

FIGURE 13, Turn-On Energy Loss vs Collector Current

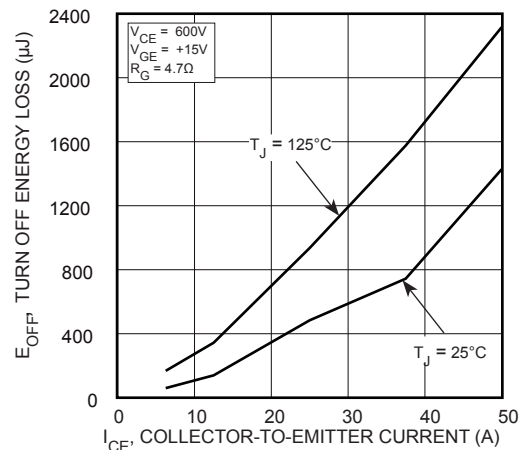

FIGURE 14, Turn-Off Energy Loss vs Collector Current

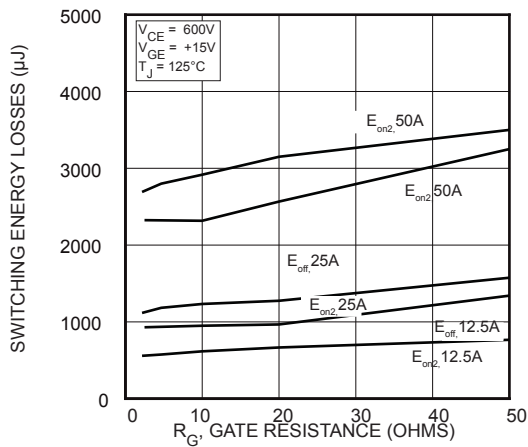

FIGURE 15, Switching Energy Losses vs Gate Resistance

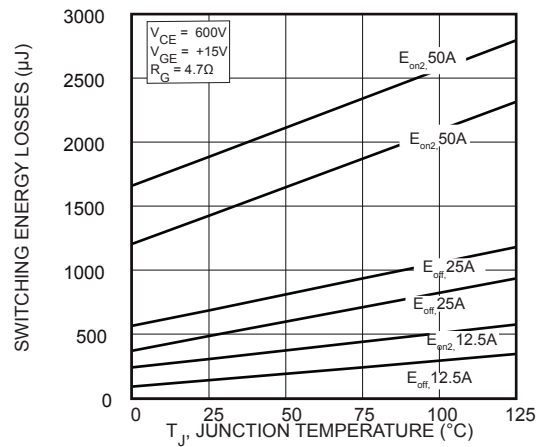

FIGURE 16, Switching Energy Losses vs Junction Temperature

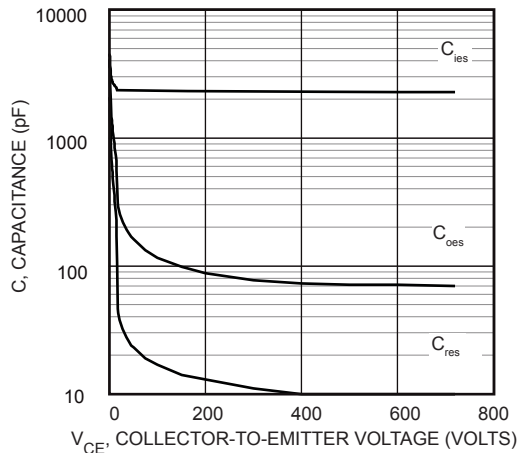

FIGURE 17, Capacitance vs Collector-To-Emitter Voltage

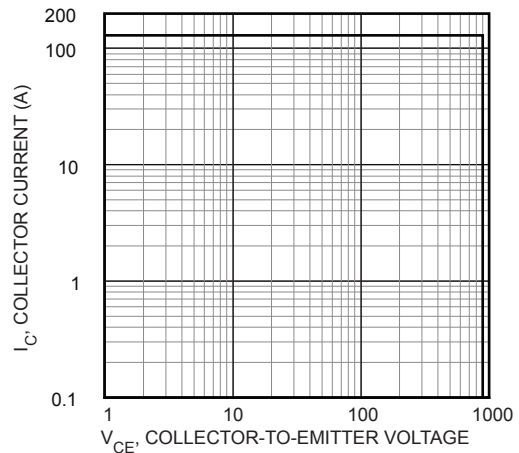

FIGURE 18, Minimum Switching Safe Operating Area

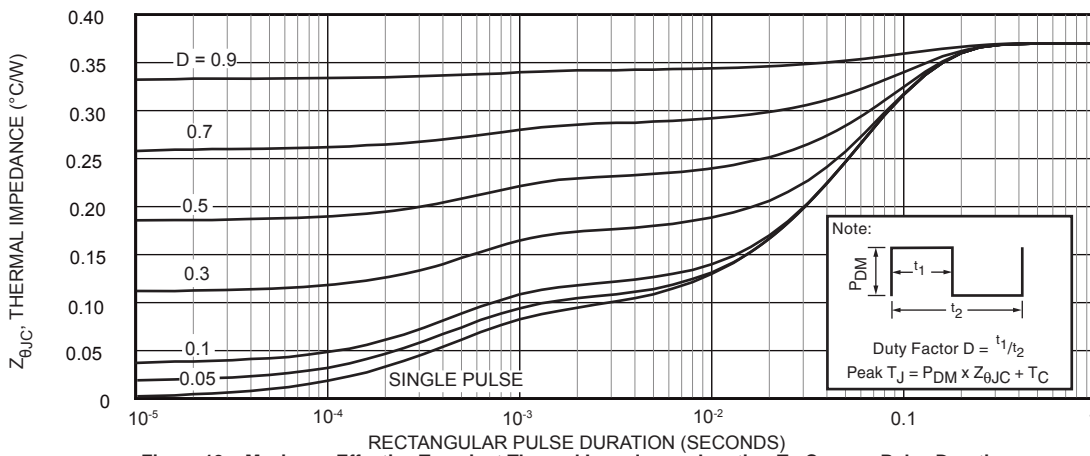

Figure 19a, Maximum Effective Transient Thermal Impedance, Junction-To-Case vs Pulse Duration

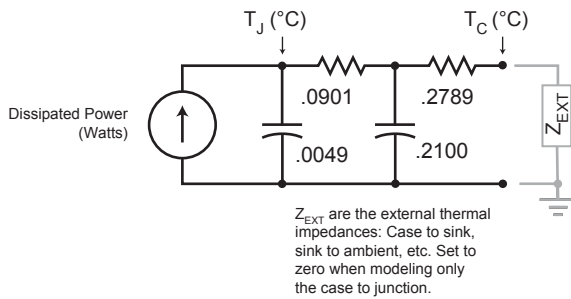

FIGURE 19b, TRANSIENT THERMAL IMPEDANCE MODEL

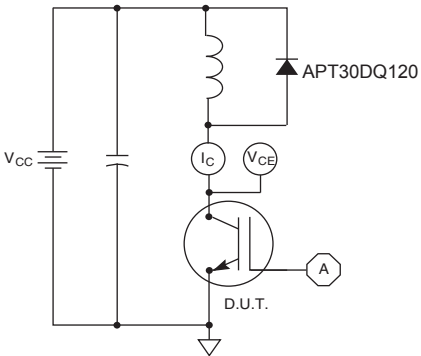

Figure 20, Inductive Switching Test Circuit

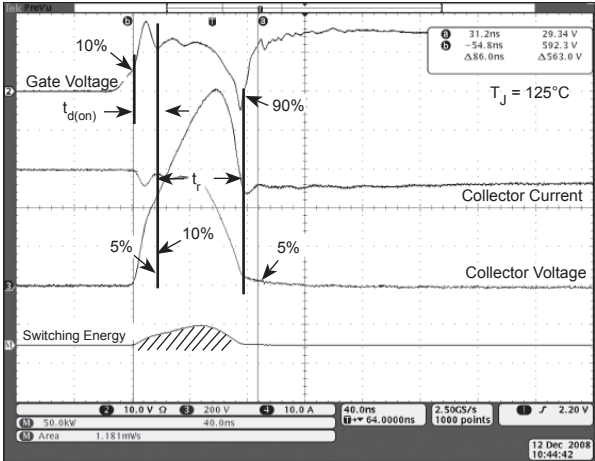

Figure 21, Turn-on Switching Waveforms and Definitions

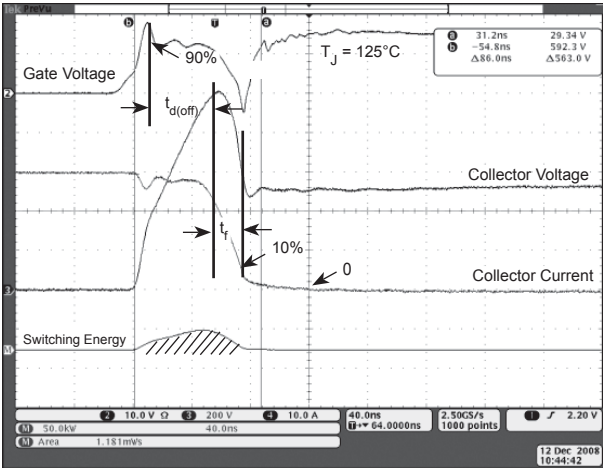

Figure 22, Turn-off Switching Waveforms and Definitions

# ULTRAFAST SOFT RECOVERY RECTIFIER DIODE

## MAXIMUM RATINGS

All Ratings:  $T_C = 25^\circ\text{C}$  unless otherwise specified.

| Symbol       | Characteristic / Test Conditions  | APT43GA90BD30 | Unit |
|--------------|---|---------------|------|
| $I_{F(AV)}$  | Maximum Average Forward Current ( $T_C = 117^\circ\text{C}$ , Duty Cycle = 0.5) | 30            | Amps |
| $I_{F(RMS)}$ | RMS Forward Current (Square wave, 50% duty)                                     | 51            |      |
| $I_{FSM}$    | Non-Repetitive Forward Surge Current ( $T_J = 45^\circ\text{C}$ , 8.3 ms)       | 320           |      |

## STATIC ELECTRICAL CHARACTERISTICS

| Symbol | Characteristic / Test Conditions | Min   | Type | Max | Unit  |
|--------|----------------------------------|---|------|-----|-------|
| $V_F$  | Forward Voltage                  | $I_F = 30\text{A}$                          |      | 2.0 | Volts |
|        |                                  | $I_F = 60\text{A}$                          |      | 2.4 |       |
|        |                                  | $I_F = 30\text{A}, T_J = 125^\circ\text{C}$ |      | 1.7 |       |

## DYNAMIC CHARACTERISTICS

| Symbol    | Characteristic                   | Test Conditions   | Min | Typ | Max | Unit |
|-----------|----------------------------------|---|-----|-----|-----|------|
| $t_{rr}$  | Reverse Recovery Time            | $I_F = 1\text{A}, di_F/dt = -100\text{A}/\mu\text{s}, V_R = 30\text{V}, T_J = 25^\circ\text{C}$     | -   | 23  | -   | ns   |
| $t_{rr}$  | Reverse Recovery Time            | $I_F = 30\text{A}, di_F/dt = -200\text{A}/\mu\text{s}, V_R = 400\text{V}, T_C = 25^\circ\text{C}$   | -   | 30  | -   |      |
| $Q_{rr}$  | Reverse Recovery Charge          |   | -   | 55  | -   | nC   |
| $I_{RRM}$ | Maximum Reverse Recovery Current |   | -   | 3   | -   | Amps |
| $t_{rr}$  | Reverse Recovery Time            | $I_F = 30\text{A}, di_F/dt = -200\text{A}/\mu\text{s}, V_R = 400\text{V}, T_C = 125^\circ\text{C}$  | -   | 175 | -   | ns   |
| $Q_{rr}$  | Reverse Recovery Charge          |   | -   | 485 | -   | nC   |
| $I_{RRM}$ | Maximum Reverse Recovery Current |   | -   | 6   | -   | Amps |
| $t_{rr}$  | Reverse Recovery Time            | $I_F = 30\text{A}, di_F/dt = -1000\text{A}/\mu\text{s}, V_R = 400\text{V}, T_C = 125^\circ\text{C}$ | -   | 75  | -   | ns   |
| $Q_{rr}$  | Reverse Recovery Charge          |   | -   | 855 | -   | nC   |
| $I_{RRM}$ | Maximum Reverse Recovery Current |   | -   | 22  | -   | Amps |

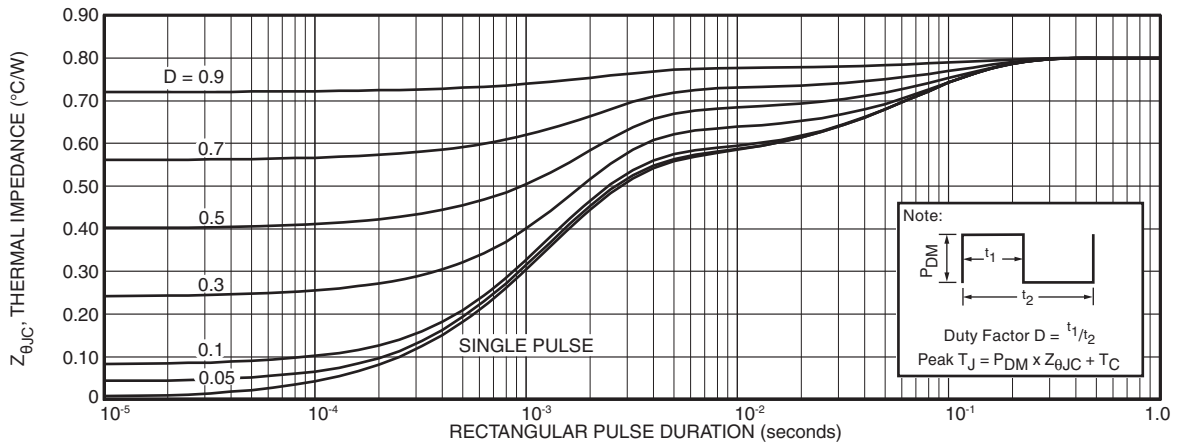

FIGURE 1a. MAXIMUM EFFECTIVE TRANSIENT THERMAL IMPEDANCE, JUNCTION-TO-CASE vs. PULSE DURATION

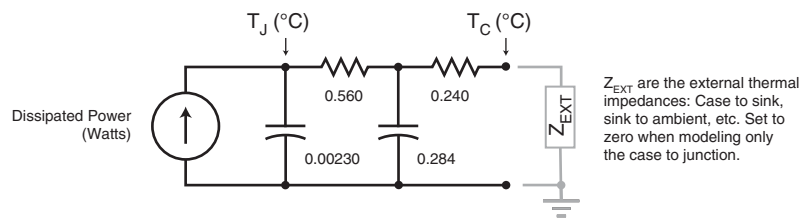

FIGURE 1b. TRANSIENT THERMAL IMPEDANCE MODEL

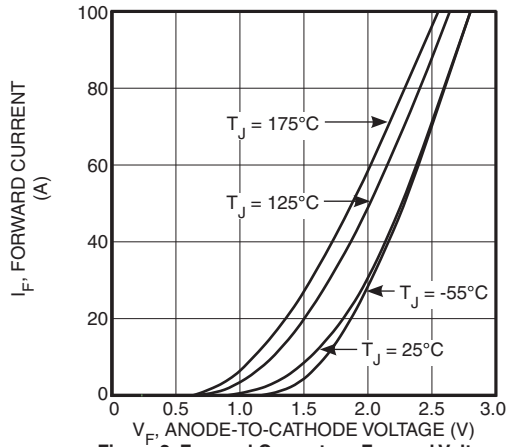

Figure 2. Forward Current vs. Forward Voltage

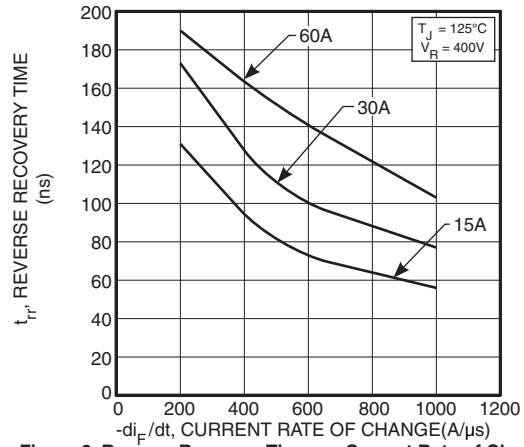

Figure 3. Reverse Recovery Time vs. Current Rate of Change

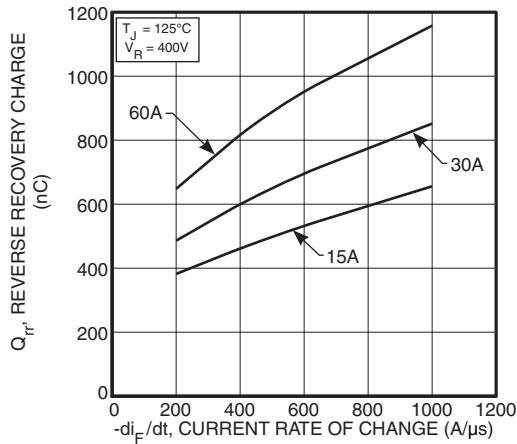

Figure 4. Reverse Recovery Charge vs. Current Rate of Change

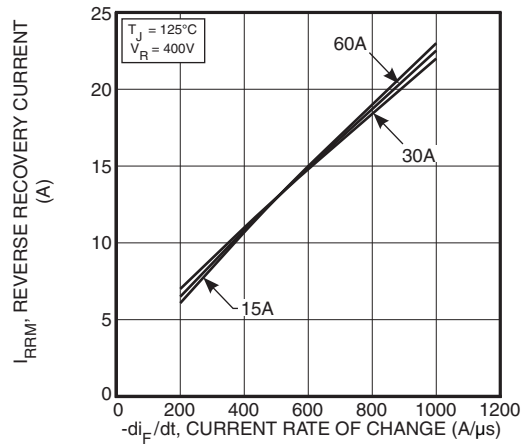

Figure 5. Reverse Recovery Current vs. Current Rate of Change

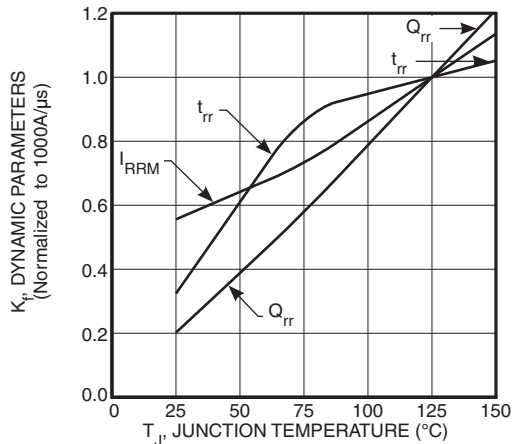

Figure 6. Dynamic Parameters vs. Junction Temperature

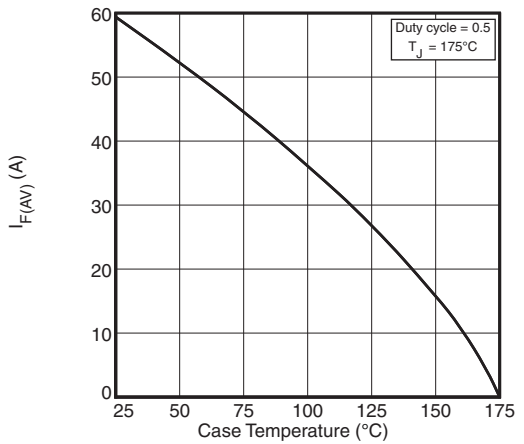

Figure 7. Maximum Average Forward Current vs. Case Temperature

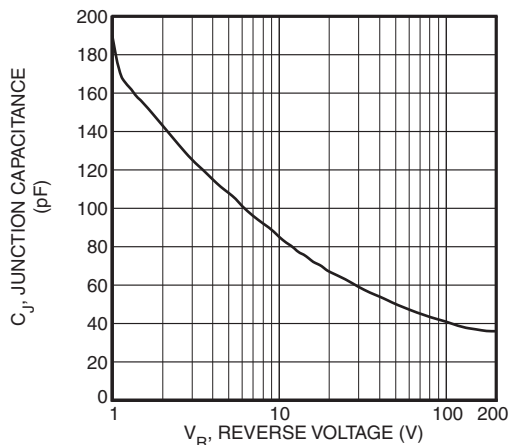

Figure 8. Junction Capacitance vs. Reverse Voltage



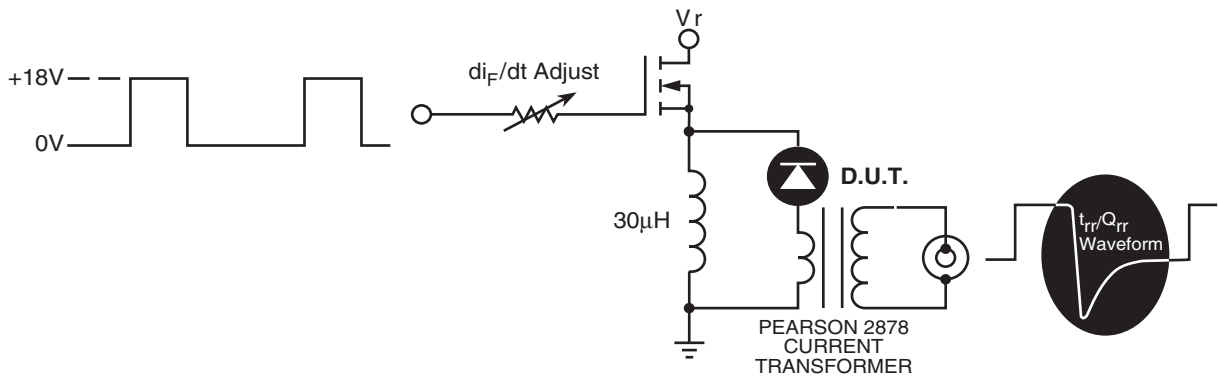

Figure 9. Diode Test Circuit

- 1 I<sub>F</sub> - Forward Conduction Current
- 2 di<sub>F</sub>/dt - Rate of Diode Current Change Through Zero Crossing.
- 3 I<sub>RRM</sub> - Maximum Reverse Recovery Current.
- 4 t<sub>rr</sub> - Reverse Recovery Time, measured from zero crossing where diode current goes from positive to negative, to the point at which the straight line through I<sub>RRM</sub> and 0.25 • I<sub>RRM</sub> passes through zero.
- 5 Q<sub>rr</sub> - Area Under the Curve Defined by I<sub>RRM</sub> and t<sub>rr</sub>.

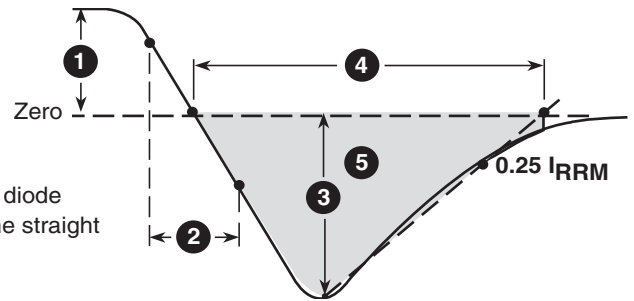
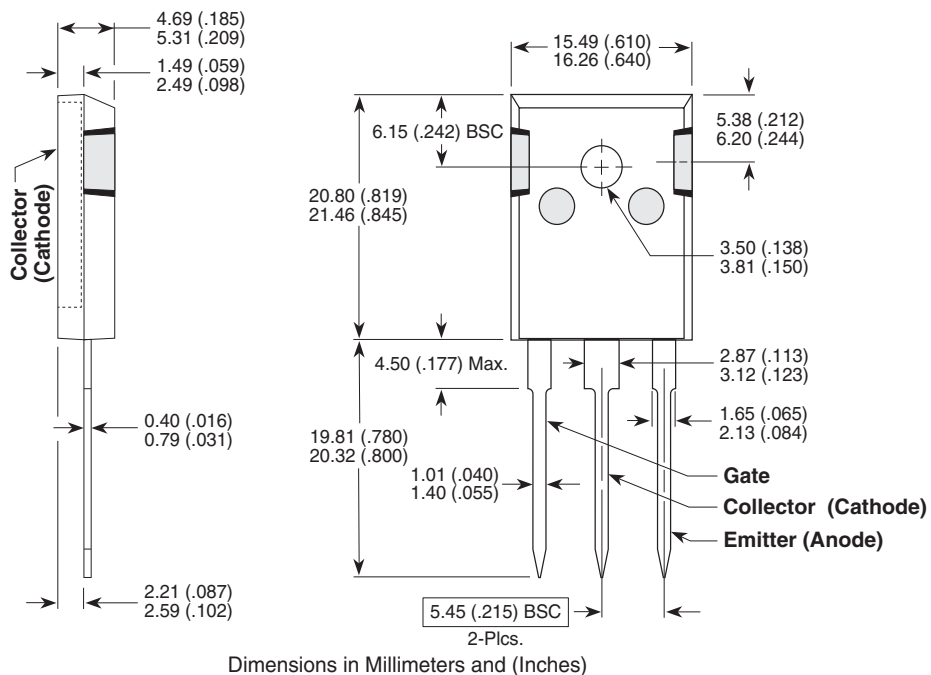

Figure 10, Diode Reverse Recovery Waveform and Definitions

TO-247 (B) Package Outline



Dimensions in Millimeters and (Inches)