

# Notice for TAIYO YUDEN products

Please read this notice before using the TAIYO YUDEN products.



## REMINDERS

- Product information in this catalog is as of October 2008. All of the contents specified herein are subject to change without notice due to technical improvements, etc. Therefore, please check for the latest information carefully before practical application or usage of the Products.

Please note that Taiyo Yuden Co., Ltd. shall not be responsible for any defects in products or equipment incorporating such products, which are caused under the conditions other than those specified in this catalog or individual specification.

- Please contact Taiyo Yuden Co., Ltd. for further details of product specifications as the individual specification is available.
- Please conduct validation and verification of products in actual condition of mounting and operating environment before commercial shipment of the equipment.
- All electronic components or functional modules listed in this catalog are developed, designed and intended for use in general electronics equipment.(for AV, office automation, household, office supply, information service, telecommunications, (such as mobile phone or PC) etc.). Before incorporating the components or devices into any equipment in the field such as transportation,( automotive control, train control, ship control), transportation signal, disaster prevention, medical, public information network (telephone exchange, base station) etc. which may have direct influence to harm or injure a human body, please contact Taiyo Yuden Co., Ltd. for more detail in advance.

Do not incorporate the products into any equipment in fields such as aerospace, aviation, nuclear control, submarine system, military, etc. where higher safety and reliability are especially required.

In addition, even electronic components or functional modules that are used for the general electronic equipment, if the equipment or the electric circuit require high safety or reliability function or performances, a sufficient reliability evaluation check for safety shall be performed before commercial shipment and moreover, due consideration to install a protective circuit is strongly recommended at customer's design stage.

- The contents of this catalog are applicable to the products which are purchased from our sales offices or distributors (so called "TAIYO YUDEN' s official sales channel"). It is only applicable to the products purchased from any of TAIYO YUDEN' s official sales channel.
- Please note that Taiyo Yuden Co., Ltd. shall have no responsibility for any controversies or disputes that may occur in connection with a third party's intellectual property rights and other related rights arising from your usage of products in this catalog. Taiyo Yuden Co., Ltd. grants no license for such rights.
- Caution for export  
Certain items in this catalog may require specific procedures for export according to "Foreign Exchange and Foreign Trade Control Law" of Japan, "U.S. Export Administration Regulations," and other applicable regulations. Should you have any question or inquiry on this matter, please contact our sales staff.  
Should you have any question or inquiry on this matter, please contact our sales staff.

# 積層ハイロスインダクタレイ

## MULTILAYER FERRITE CHIP BEAD ARRAY

### BK ARRAY SERIES

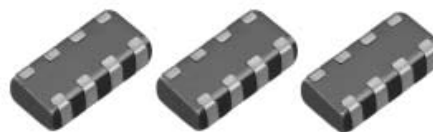

OPERATING TEMP.	-55~+125°C
-----------------	------------



### 特長 FEATURES

- ・周波数特性、インピーダンス値を幅広いバリエーションで用意しているため、各種ノイズを対策可能
- ・1チップで4ラインの対策が可能になり、より高密度、高効率な実装を実現
- ・各回路間のクロストークや、チップの発熱を極力抑制
- ・ Available in a wide range of frequency characteristics and impedance values providing excellent suppression of various noise.
- ・ 4 line action in one chip is available for mounting with higher density and efficiency.
- ・ Heat generation and crosstalk between adjacent circuits is minimized.

### 用途 APPLICATIONS

- ・ノートパソコン、液晶モジュール等、小形軽量の携帯機器に於ける発生源対策・輻射ノイズ対策
- ・インターフェイス、ハーネス接続部での輻射ノイズ対策
- ・ Radiated noise suppression in note-PC, LCD module and other portable equipment.
- ・ Radiated noise suppression in interfaces and harness connecting parts.

### 形名表記法 ORDERING CODE

1	3	4	5	6
形式	材質記号	公称インピーダンス [Ω]	包装	当社管理記号
BK   積層ハイロスインダクタ	4W 4S   材質によりインピーダンス特性が異なる 4M 4L	例 601   600 102   1000	-T   リールテーピング	△   標準品 △=スペース
2				
形状寸法 (L×W) [mm]				
2010 (0804)   2.0×1.0 3216 (1206)   3.2×1.6				

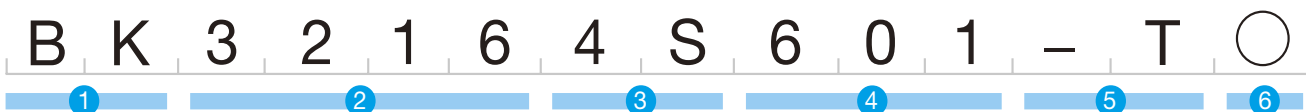

1	3	4	5	6
Type	Material	Nominal Impedance [Ω]	Packaging	Internal code
BK   Multilayer ferrite chip beads	4W 4S   Refer to impedance curves for material difference 4M 4L	example 601   600 102   1000	-T   Tape&Reel	△   Standard Products △=Blank Space
2				
External Dimension (L×W) [mm]				
2010 (0804)   2.0×1.0 3216 (1206)   3.2×1.6				

# 外形寸法 EXTERNAL DIMENSIONS

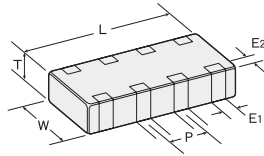

Type	Material	L	W	T	E1	E2	P
BK2010	4W, 4S, 4M (0804)	2.0±0.15 (0.079±0.006)	1.0±0.15 (0.039±0.006)	0.45±0.05 (0.018±0.002)	0.25 <sup>+0.15</sup> <sub>-0.1</sub> (0.010 <sup>+0.006</sup> <sub>-0.004</sub> )	0.25±0.15 (0.010±0.006)	0.5±0.1 (0.020±0.004)
BK3216	4W, 4S, 4M, (1206)	3.2±0.2 (0.126±0.008)	1.6±0.2 (0.063±0.008)	0.8±0.1 (0.031±0.004)	0.35±0.2 (0.014±0.008)	0.3±0.2 (0.012±0.008)	0.8±0.1 (0.031±0.004)

Unit : mm (inch)

# 概略バリエーション AVAILABLE MATERIALS

## BK2010

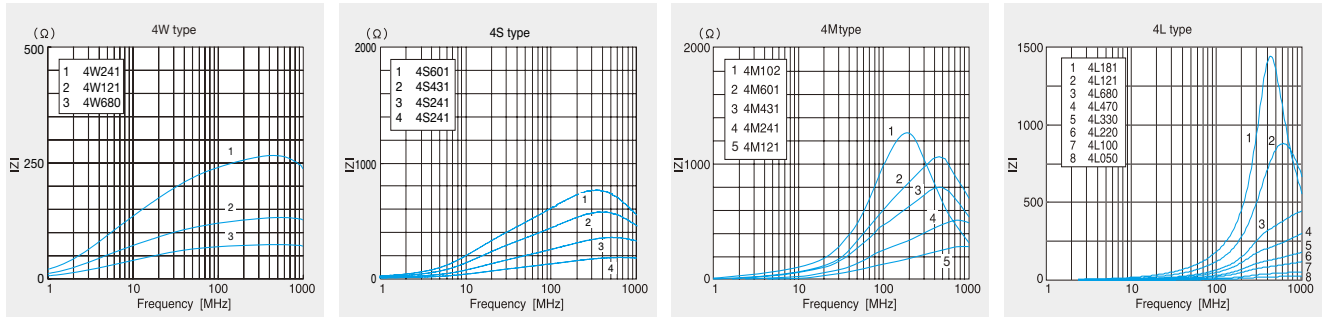

## BK3216

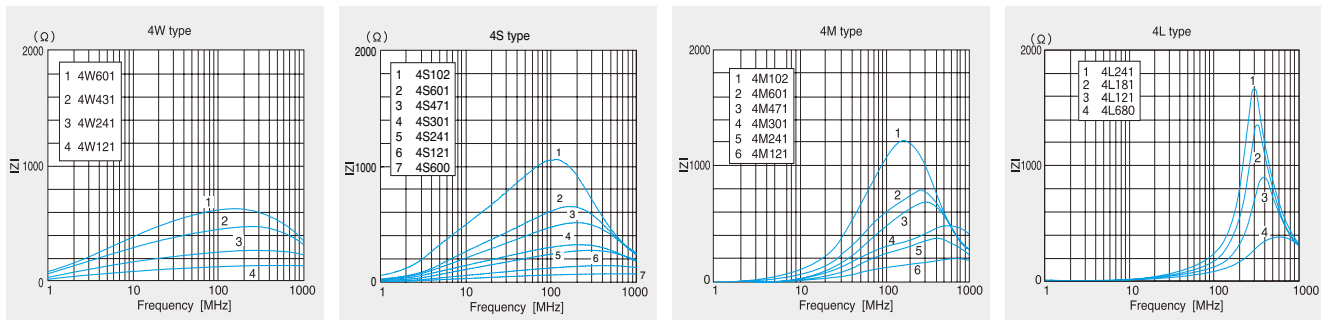

セレクトションガイド  
Selection Guide

アイテム一覧  
Part Numbers

特性図  
Electrical Characteristics

梱包  
Packaging

信頼性  
Reliability Data

使用上の注意  
Precautions



etc

△当社カタログをご使用の際には「当社製品に関するお断り」を必ずお読みください。

TAIYO YUDEN 2009

△Please read the "Notice for TAIYO YUDEN products" before using this catalog.

BK2010

形名 Ordering code	EHS (Environmental Hazardous Substances)	インピーダンス Impedance [Ω]±25%	測定周波数 Measuring Frequency [MHz]	直流抵抗 DC Resistance [Ω] (max.)	定格電流 Rated current [mA] (max.)
BK2010 4W680	RoHS	68	100	0.35	100
BK2010 4W121	RoHS	120		0.40	
BK2010 4W241	RoHS	240		0.50	
BK2010 4S121	RoHS	120		0.30	
BK2010 4S241	RoHS	240		0.45	
BK2010 4S431	RoHS	430		0.55	
BK2010 4S601	RoHS	600		0.70	
BK2010 4M121	RoHS	120		0.30	
BK2010 4M241	RoHS	240		0.45	
BK2010 4M431	RoHS	430		0.55	
BK2010 4M601	RoHS	600		0.70	
BK2010 4M102	RoHS	1000		0.80	
BK2010 4L050	RoHS	5		0.10	
BK2010 4L100	RoHS	10		0.15	
BK2010 4L220	RoHS	22		0.20	
BK2010 4L330	RoHS	33		0.30	
BK2010 4L470	RoHS	47		0.40	
BK2010 4L680	RoHS	68		0.50	
BK2010 4L121	RoHS	120		0.70	
BK2010 4L181	RoHS	180		0.90	

BK3216

形名 Ordering code	EHS (Environmental Hazardous Substances)	インピーダンス Impedance [Ω]±25%	測定周波数 Measuring Frequency [MHz]	直流抵抗 DC Resistance [Ω] (max.)	定格電流 Rated current [mA] (max.)
BK3216 4W121	RoHS	120	100	0.15	100
BK3216 4W241	RoHS	240		0.25	100
BK3216 4W431	RoHS	430		0.35	100
BK3216 4W601	RoHS	600		0.40	100
BK3216 4S600	RoHS	60		0.18	200
BK3216 4S121	RoHS	120		0.18	200
BK3216 4S241	RoHS	240		0.30	200
BK3216 4S301	RoHS	300		0.40	200
BK3216 4S471	RoHS	470		0.40	200
BK3216 4S601	RoHS	600		0.45	200
BK3216 4S102	RoHS	1000		0.68	100
BK3216 4M121	RoHS	120		0.20	150
BK3216 4M241	RoHS	240		0.35	150
BK3216 4M301	RoHS	300		0.45	150
BK3216 4M471	RoHS	470		0.50	150
BK3216 4M601	RoHS	600		0.60	100
BK3216 4M102	RoHS	1000		0.80	100
BK3216 4L680	RoHS	68		0.35	200
BK3216 4L121	RoHS	120		0.55	200
BK3216 4L181	RoHS	180		0.65	150
BK3216 4L241	RoHS	240	0.75	150	

BK2010

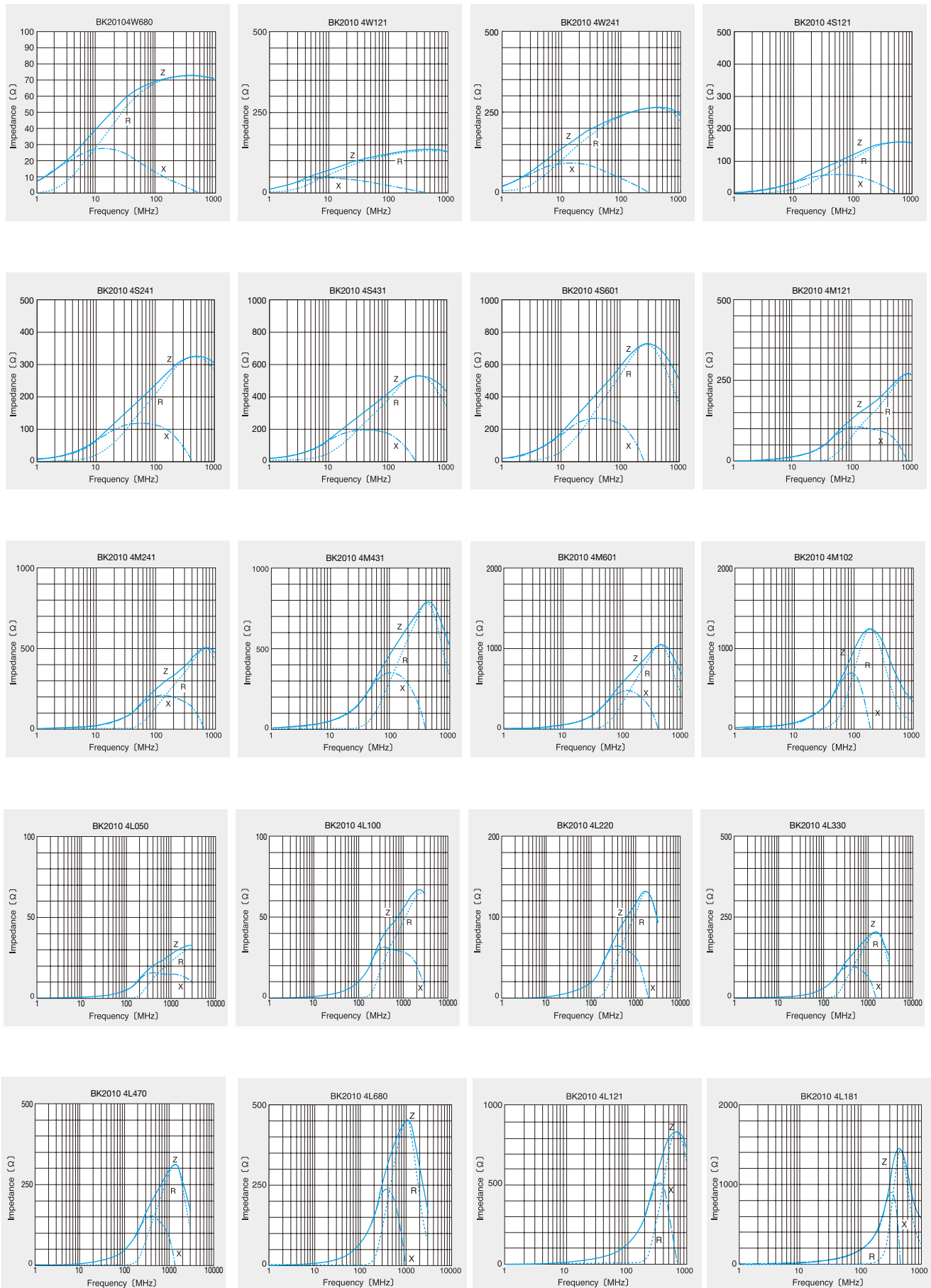

BK3216

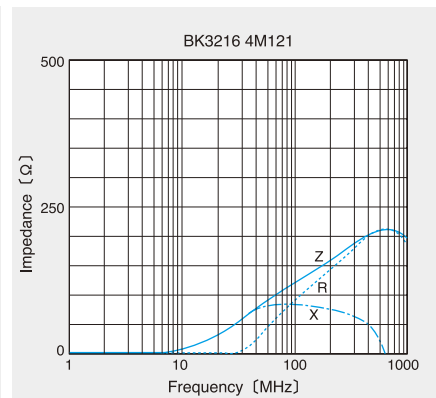
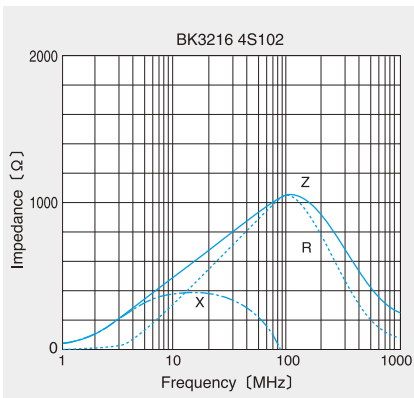
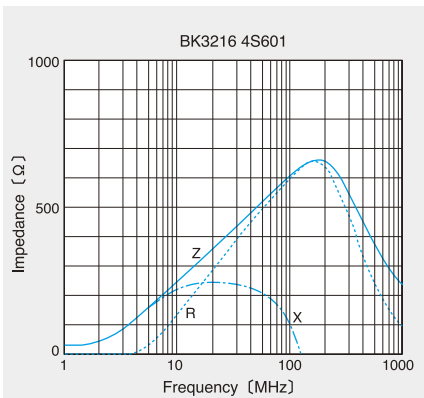
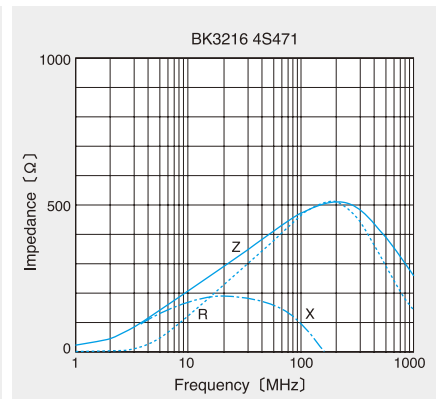
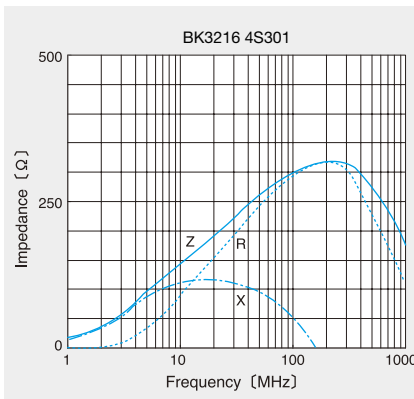
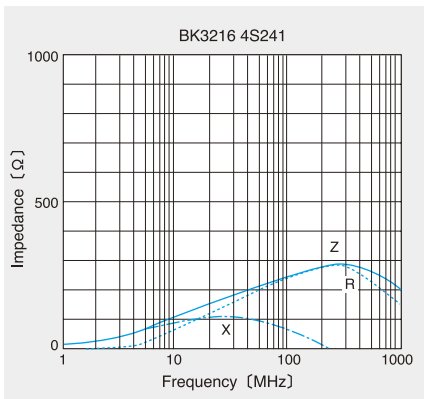
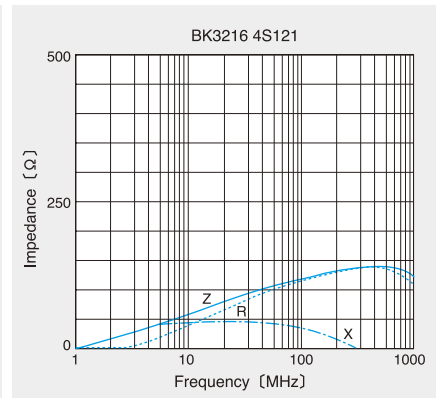
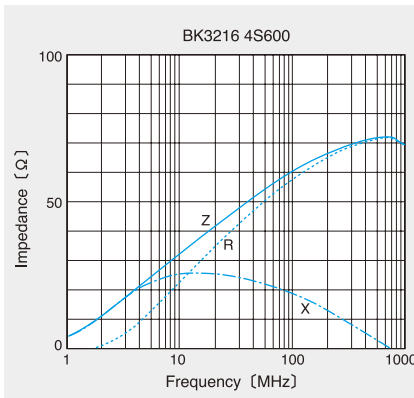
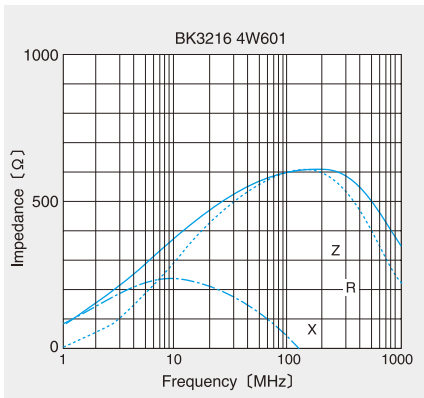
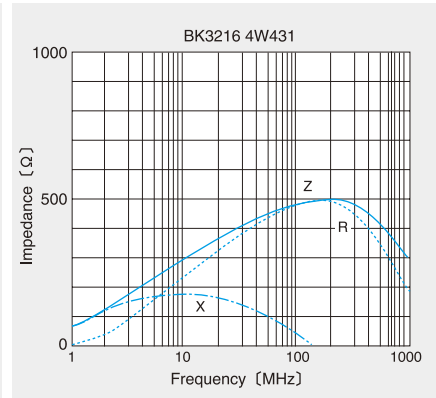
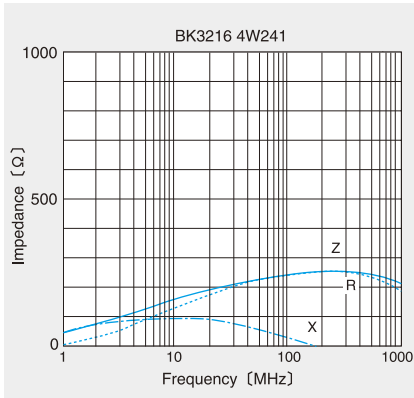
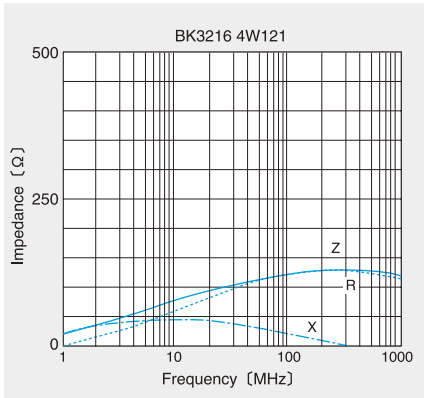

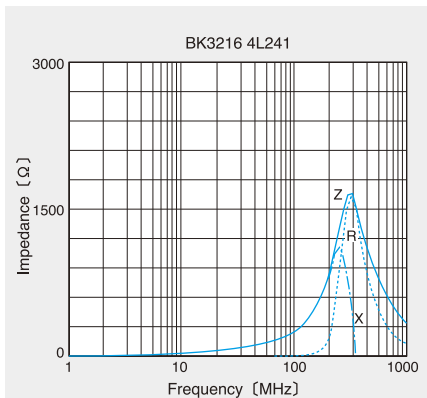
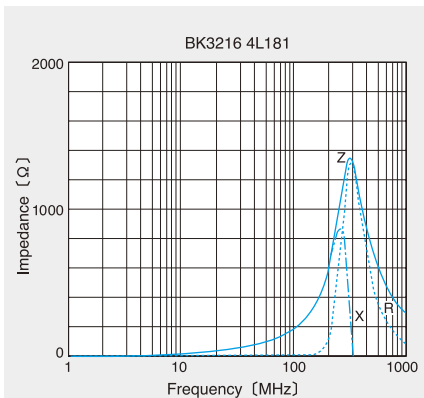
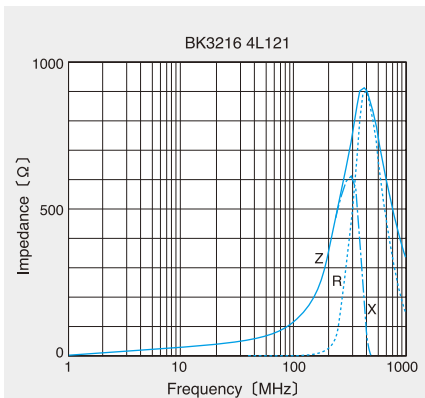
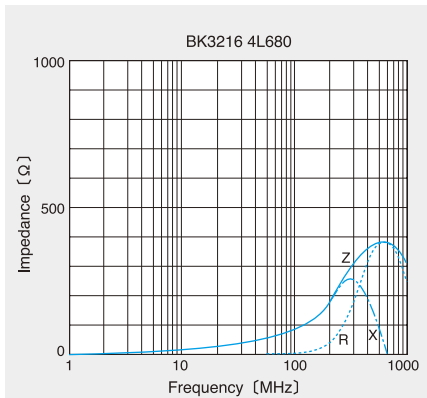
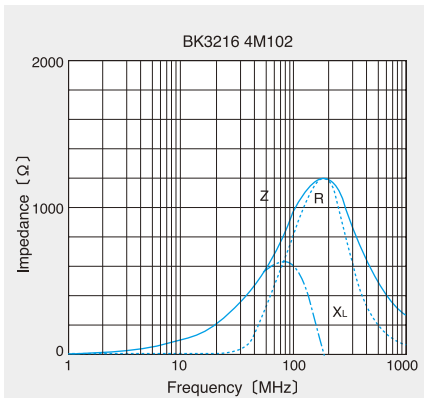
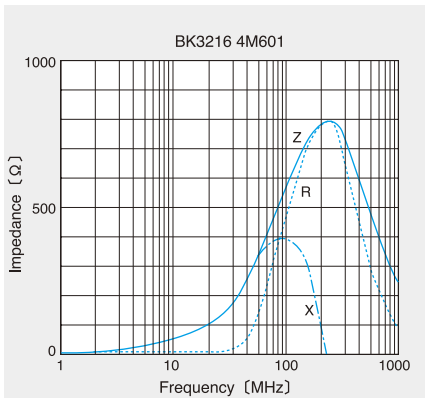
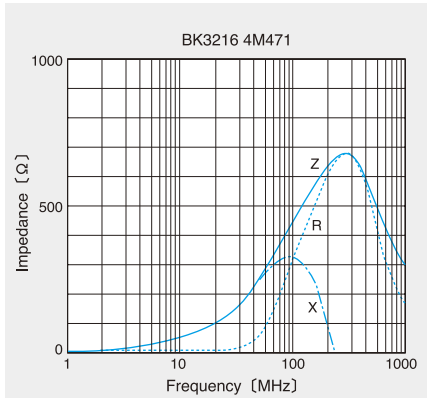
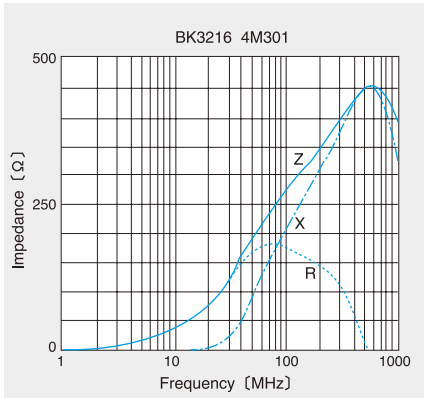
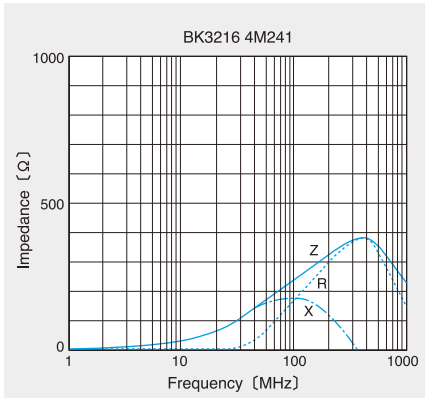



①最小受注単位数 Minimum Quantity  
 ■テーピング梱包 Tape & Reel Packaging

形式 Type	製品厚み Thickness [mm] (inch)	標準数量 [pcs] Standard Quantity	
		紙テープ Paper Tape	エンボステープ Embossed Tape
CK1608(0603)	0.8 (0.031)	4000	—
CK2125(0805)	0.85 (0.033)	4000	—
	1.25 (0.049)	—	2000
CKP2520(1008)	0.9 (0.035)	—	3000
	1.1 (0.043)	—	2000
LK1005(0402)	0.5 (0.020)	10000	—
LK1608(0603)	0.8 (0.031)	4000	—
LK2125(0805)	0.85 (0.033)	4000	—
	1.25 (0.049)	—	2000
HK0603(0201)	0.3 (0.012)	15000	—
HK1005(0402)	0.5 (0.020)	10000	—
HK1608(0603)	0.8 (0.031)	4000	—
HK2125(0805)	0.85 (0.033)	—	4000
	1.0 (0.039)	—	3000
HKQ0603S(0201)	0.3 (0.012)	15000	—
AQ105(0402)	0.5 (0.020)	10000	—
BK0603(0201)	0.3 (0.012)	15000	—
BK1005(0402)	0.5 (0.020)	10000	—
BK1608(0603)	0.8 (0.031)	4000	—
BK2125(0805)	0.85 (0.033)	4000	—
	1.25 (0.049)	—	2000
BK2010(0804)	0.45 (0.018)	4000	—
BK3216(1206)	0.8 (0.031)	—	4000
BKP0603(0201)	0.3 (0.012)	15000	—
BKP1005(0402)	0.5 (0.020)	10000	—
BKP1608(0603)	0.8 (0.031)	4000	—
BKP2125(0805)	0.85 (0.033)	4000	—

②テーピング材質 Taping material

紙テープ

Card board carrier tape

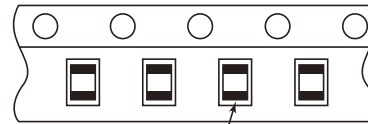
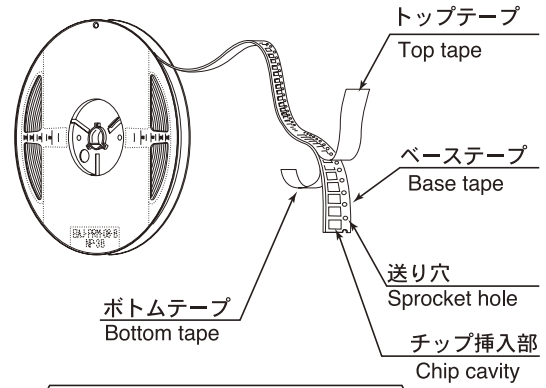

CK	1 6 0 8
CK	2 1 2 5
LK	1 0 0 5
LK	1 6 0 8
LK	2 1 2 5
HK	0 6 0 3
HK	1 0 0 5
HK	1 6 0 8
HK Q	0 6 0 3
AQ	1 0 5
BK	0 6 0 3
BK	1 0 0 5
BK	1 6 0 8
BK	2 1 2 5
BK	2 0 1 0
BK P	0 6 0 3
BK P	1 0 0 5
BK P	1 6 0 8
BK P	2 1 2 5

エンボステープ  
Embossed Tape

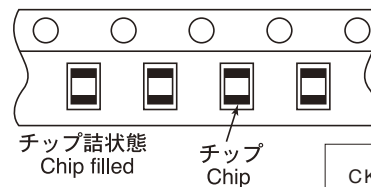
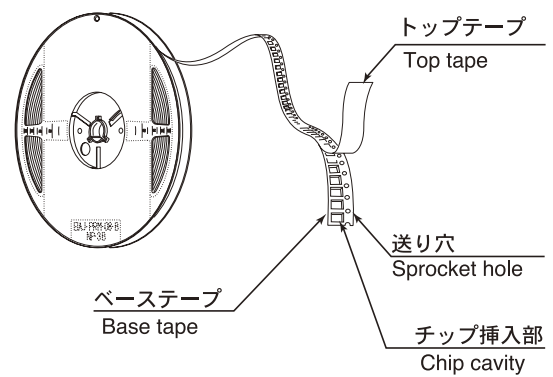

CK	2125
CKP	2520
LK	2125
HK	2125
BK	2125
BK	3216



③テーピング寸法 Taping Dimensions

・紙テープ (8mm幅) Paper tape (0.315 inches wide)

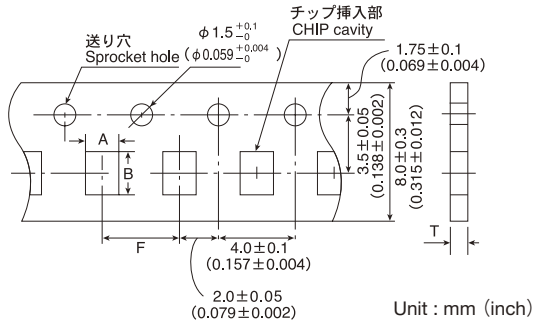

形式 Type	製品厚み Thickness (mm) (inch)	チップ挿入部 Chip cavity		挿入ピッチ Insertion Pitch	テープ厚み Tape Thickness	
		A	B		F	T
CK1608(0603)	0.8 (0.031)	1.0±0.2 (0.039±0.008)	1.8±0.2 (0.071±0.008)	4.0±0.1 (0.157±0.004)	1.1max x (0.043max)	
CK2125(0805)	0.85 (0.033)	1.5±0.2 (0.059±0.008)	2.3±0.2 (0.091±0.008)	4.0±0.1 (0.157±0.004)	1.1max x (0.043max)	
LK1005(0402)	0.5 (0.020)	0.65±0.1 (0.026±0.004)	1.15±0.1 (0.045±0.004)	2.0±0.05 (0.079±0.002)	0.8max x (0.031max)	
LK1608(0603)	0.8 (0.031)	1.0±0.2 (0.039±0.008)	1.8±0.2 (0.071±0.008)	4.0±0.1 (0.157±0.004)	1.1max x (0.043max)	
LK2125(0805)	0.85 (0.033)	1.5±0.2 (0.059±0.008)	2.3±0.2 (0.091±0.008)	4.0±0.1 (0.157±0.004)	1.1max x (0.043max)	
HK0603(0201)	0.3 (0.012)	0.40±0.06 (0.016±0.002)	0.70±0.06 (0.028±0.002)	2.0±0.05 (0.079±0.002)	0.45max x (0.018max)	
HK1005(0402)	0.5 (0.020)	0.65±0.1 (0.026±0.004)	1.15±0.1 (0.045±0.004)	2.0±0.05 (0.079±0.002)	0.8max x (0.031max)	
HK1608(0603)	0.8 (0.031)	1.0±0.2 (0.039±0.008)	1.8±0.2 (0.071±0.008)	4.0±0.1 (0.157±0.004)	1.1max x (0.043max)	
HKQ0603S(0201)	0.3 (0.012)	0.40±0.06 (0.016±0.002)	0.70±0.06 (0.028±0.002)	2.0±0.05 (0.079±0.002)	0.45max x (0.018max)	
AQ105(0402)	0.5 (0.020)	0.75±0.1 (0.030±0.004)	1.15±0.1 (0.045±0.004)	2.0±0.05 (0.079±0.002)	0.8max x (0.031max)	
BK0603(0201)	0.3 (0.012)	0.40±0.06 (0.016±0.002)	0.70±0.06 (0.028±0.002)	2.0±0.05 (0.079±0.002)	0.45max x (0.018max)	
BK1005(0402)	0.5 (0.020)	0.65±0.1 (0.026±0.004)	1.15±0.1 (0.045±0.004)	2.0±0.05 (0.079±0.002)	0.8max x (0.031max)	
BK1608(0603)	0.8 (0.031)	1.0±0.2 (0.039±0.008)	1.8±0.2 (0.071±0.008)	4.0±0.1 (0.157±0.004)	1.1max x (0.043max)	
BK2125(0805)	0.85 (0.033)	1.5±0.2 (0.059±0.008)	2.3±0.2 (0.091±0.008)	4.0±0.1 (0.157±0.004)	1.1max x (0.043max)	
BK2010(0804)	0.45 (0.018)	1.2±0.1 (0.047±0.004)	2.17±0.1 (0.085±0.004)	4.0±0.1 (0.157±0.004)	0.8max x (0.031max)	
BKP0603(0201)	0.3 (0.012)	0.40±0.06 (0.016±0.002)	0.70±0.06 (0.028±0.002)	2.0±0.05 (0.079±0.002)	0.45max x (0.018max)	
BKP1005(0402)	0.5 (0.020)	0.65±0.1 (0.026±0.004)	1.15±0.1 (0.045±0.004)	2.0±0.05 (0.079±0.002)	0.8max x (0.031max)	
BKP1608(0603)	0.8 (0.031)	1.0±0.2 (0.039±0.008)	1.8±0.2 (0.071±0.008)	4.0±0.1 (0.157±0.004)	1.1max x (0.043max)	
BKP2125(0805)	0.85 (0.033)	1.5±0.2 (0.059±0.008)	2.3±0.2 (0.091±0.008)	4.0±0.1 (0.157±0.004)	1.1max x (0.043max)	

・エンボステープ (8mm幅) Embossed Tape (0.312 inches wide)

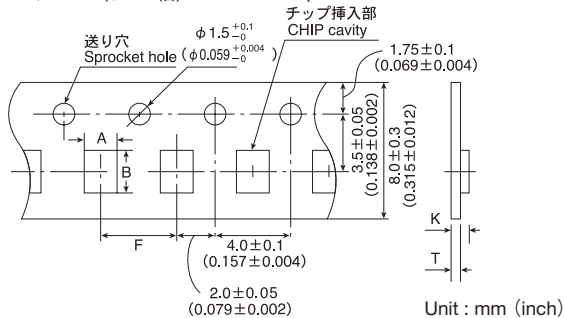

形式 Type	製品厚み Thickness (mm) (inch)	チップ挿入部 Chip cavity		挿入ピッチ Insertion Pitch	テープ厚み Tape Thickness	
		A	B		F	K
CK2125(0805)	1.25 (0.049)	1.5±0.2 (0.059±0.008)	2.3±0.2 (0.091±0.008)	4.0±0.1 (0.157±0.004)	2.0 (0.079)	0.3 (0.012)
CKP2520(1008)	0.9 (0.035)	2.3±0.1 (0.091±0.004)	2.8±0.1 (0.110±0.004)	4.0±0.1 (0.157±0.004)	1.4 (0.055)	0.3 (0.012)
	1.1 (0.043)				1.7 (0.067)	
LK2125(0805)	1.25 (0.049)	1.5±0.2 (0.059±0.008)	2.3±0.2 (0.091±0.008)	4.0±0.1 (0.157±0.004)	2.0 (0.079)	0.3 (0.012)
HK2125(0805)	0.85 (0.033)	1.5±0.2 (0.059±0.008)	2.3±0.2 (0.091±0.008)	4.0±0.1 (0.157±0.004)	1.5 (0.059)	0.3 (0.012)
	1.0 (0.039)				2.0 (0.079)	
BK2125(0805)	1.25 (0.049)	1.5±0.2 (0.059±0.008)	2.3±0.2 (0.091±0.008)	4.0±0.1 (0.157±0.004)	2.0 (0.079)	0.3 (0.012)
BK3216(1206)	0.8 (0.031)	1.9±0.1 (0.075±0.004)	3.5±0.1 (0.138±0.004)	4.0±0.1 (0.157±0.004)	1.4 (0.055)	0.3 (0.012)

④リーダー部・空部 LEADER AND BLANK PORTION

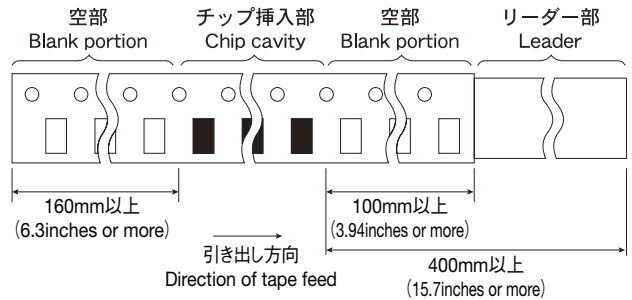

⑤リール寸法 Reel Size

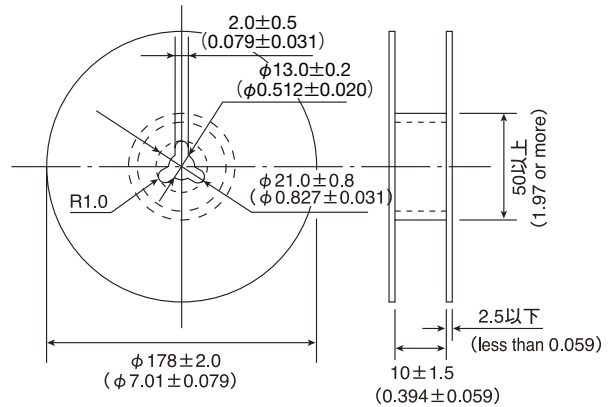

⑥トップテープ強度 Top tape strength

トップテープの剥離力は、下図矢印方向にて0.1~0.7Nとなります。The top tape requires a peel-off force of 0.1~0.7N in the direction of the arrow as illustrated below.

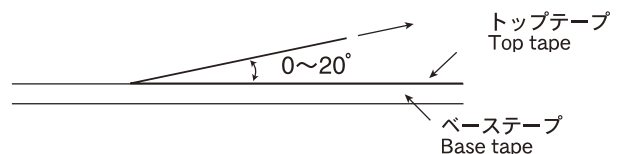

Multilayer chip inductors and beads

Item	Specified Value																				Test Methods and Remarks					
	BK0603	BK1005	BK1608	BK2125	ARRAY		BKP0603	BKP1005	BKP1608	BKP2125	CK1608	CK2125	CKP2520	LK1005	LK1608	LK2125	HK0603	HK1005	HK1608	HK2125		HKQ0603S	AQ105			
					DC	DC																				
1. Operating Temperature Range	-55~+125°C				-55~+85°C				-40~+85°C				-55~+125°C				-40~+85°C				-55~+125°C					
2. Storage Temperature Range	-55~+125°C				-55~+85°C				-40~+85°C				-55~+125°C				-40~+85°C				-55~+125°C					
3. Rated Current	100~500mA DC	150~1000mA DC	150~1500mA DC	200~1200mA DC	100~200mA DC	1.0A DC	1.0A DC	1.0~3.0A DC	2.0~4.0A DC	50~60mA DC	60~500mA DC	1.1~1.4 DC	10~25mA DC	1~50mA DC	5~300mA DC	60~470mA DC	110~300mA DC	150~300mA DC	300mA DC	300mA DC	130~600mA DC	280~710mA DC				
4. Impedance	10~600Ω ±25%	10~1000Ω ±25%	22~2500Ω ±25%	15~2500Ω ±25%	5~600Ω ±25%	68~1000Ω ±25%	22~33Ω ±25%	120Ω ±25%	33~390Ω ±25%	33~220Ω ±25%																
5. Impedance											4.7~10.0μH : ±20%	0.1~10.0μH : ±20%	1.0~4.7μH : ±10%	0.12~2.2μH : ±10%	0.047~33.0μH : ±20%	0.047~33.0μH : ±20%	1.0~6.2nH : ±0.3nH	1.0~6.2nH : ±0.3nH	1.0~5.6nH : ±0.3nH	1.0~5.6nH : ±0.3nH	1.0~6.8nH : ±0.3nH	1.0~6.8nH : ±0.3nH	0.6~6.2nH : ±0.3nH	1.0~6.2nH : ±0.3nH		
<p>CK Series: Measuring frequency: 2 to 4MHz (CK1608) Measuring frequency: 2 to 25MHz (CK2125) Measuring frequency: 1MHz (CKP2520)</p> <p>LK Series: Measuring frequency: 10 to 25MHz (LK1005) Measuring frequency: 1 to 50MHz (LK1608) Measuring frequency: 0.4 to 50MHz (LK2125) Measuring equipment, jig: HP4194 + 16085B + 16092A (or its equivalent) HP4195 + 41951 + 16092A (or its equivalent) HP4294 + 16192A HP4291A+16193A (LK1005) HP4285A+42841A+42842C+42851-61100 (CKP2520) Measuring current: 1mA rms (0.047 to 4.7μH) 0.1mA rms (5.6 to 33μH) HK, AQ Series : Measuring frequency: 100MHz (HK0603 · HK1005 · AQ105) Measuring frequency: 50/100MHz (HK1608 · HK2125) Measuring frequency: 500MHz (HKQ0603S) Measuring equipment, jig: HP4291A + 16197A (HK0603 · AQ105) HP4291A + 16193A (HK1005) E4991A + 16197A (HKQ0603S) HP4291A (or its equivalent) + 16092A + in-house made jig (HK1608, 2125)</p>																										

\* Definition of rated current : In the CK and BK Series, the rated current is the value of current at which the temperature of the element is increased within 20°C .  
 In the BK Series P type and CK Series P type, the rated current is the value of current at which the temperature of the element is increased within 40°C .  
 In the LK, HK, HKQ, and AQ Series, the rated current is either the DC value at which the internal L value is decreased within 5% with the application of DC bias, or the value of current at which the temperature of the element is increased within 20°C .

Multilayer chip inductors and beads

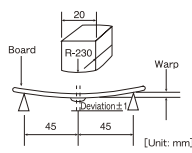
Item	Specified Value																				Test Methods and Remarks			
	BK0603	BK1005	BK1608	BK2125	ARRAY		BKP0603	BKP1005	BKP1608	BKP2125	CK1608	CK2125	CKP2520	LK1005	LK1608	LK2125	HK0603	HK1005	HK1608	HK2125		HKQ0603S	AQ105	
					BK2010	BK3216																		
6. Q																								CK Series : Measuring frequency : 2 to 4MHz (CK1608) Measuring frequency : 2 to 25MHz (CK2125)  LK Series : Measuring frequency : 10 to 25MHz (LK1005) Measuring frequency : 1 to 50MHz (LK1608) Measuring frequency : 0.4 to 50MHz (LK2125) Measuring equipment, jig : HP4194 + 16085B + 16092A (or its equivalent) · HP4195A + 41951 + 16092A (or its equivalent) · HP4294A + 16192A · HP4291A + 16193A (LK1005) Measuring current : · 1mA rms (0.047 to 4.7μH) · 0.1mA rms (5.6 to 33μH)  HK, HKQ, AQ Series : Measuring frequency : 100MHz (HK0603 · HK1005 · AQ105) Measuring frequency : 50/100MHz (HK1608 · HK2125) Measuring frequency : 500MHz (HKQ0603S) Measuring equipment, jig : · HP4291A + 16197A (HK0603 · AQ105) · HP4291A + 16193A (HK1005) · E4991A + 16197A (HKQ0603S) · HP4294A + 16092A+ in-house made jig (HK1608 · HK2125)
7. DC Resistance	0.07~ 1.50Ω max.	0.05~ 0.80Ω max.	0.05~ 1.10Ω max.	0.05~ 0.75Ω max.	0.10~ 0.90Ω max.	0.15~ 0.80Ω max.	0.065~ 0.070Ω max.	0.140Ω max.	0.025~ 0.140Ω max.	0.020~ 0.050Ω max.	0.45~ 0.85Ω (±30%)	0.16~ 0.65Ω max.	0.08~ 0.15 max.	0.7~ 1.70Ω max.	0.2~ 2.2Ω max.	0.1~ 1.1Ω max.	0.11~ 3.74Ω max.	0.08~ 4.8Ω max.	0.05~ 2.6Ω max.	0.10~ 1.5Ω max.	0.06~ 1.29Ω max.	0.07~ 0.45Ω max.	Measuring equipment : VOAC-7412 (made by Iwasaki Tsushinki) VOAC-7512 (made by Iwasaki Tsushinki)	
8. Self Resonance Frequency (SRF)																								LK Series : Measuring equipment : HP4195A Measuring jig : 41951+16092A (or its equivalent)  HK, HKQ, AQ Series : Measuring equipment : HP8719C HP8753D (HK2125)
9. Temperature Characteristic																								Inductance change : Within ±10%  HK, HKQ, AQ Series : Temperature range : -30 to +85°C Reference temperature : +20°C
10. Resistance to Flexure of Substrate	No mechanical damage.																				Warp : 2mm Testing board : glass epoxy-resin substrate Thickness : 0.8mm  			

Multilayer chip inductors and beads

Item	Specified Value																			Test Methods and Remarks	
	BK0603	BK1005	BK1608	BK2125	ARRAY		BKP0603	BKP1005	BKP1608	BKP2125	CK1608	CK2125	CKP2520	LK1005	LK1608	LK2125	HK0603	HK1005	HK1608		HK2125
11. Solderability	At least 75% of terminal electrode is covered by new solder.										At least 75% of terminal electrode is covered by new solder.										Solder temperature : 230±5°C Duration : 4±1 sec.
12. Resistance to Soldering	Appearance : No significant abnormality. Impedance change : Within ±30%										No mechanical damage. Remaining terminal electrode : 70% min.  Inductance change R10~4R7 : Within±10% 6R8~100 : Within±15% CKP2520 : Within±30%	No mechanical damage. Remaining terminal electrode : 70% min.  Inductance change 47N~4R7 : Within ±10% 5R6~330 : Within±15%	No mechanical damage. Remaining terminal electrode : 70% min.  Inductance change Within ±5%	No mechanical damage. Remaining terminal electrode : 70% min.  Inductance change Within ±5%	Solder temperature : 260±5°C Duration : 10±0.5 sec. Preheating temperature : 150 to 180°C Preheating time : 3 min. Flux : Immersion into methanol solution with colophony for 3 to 5 sec. Recovery : 2 to 3 hrs of recovery under the standard condition after the test. (See Note 1)						
13. Thermal Shock	Appearance : No significant abnormality. Impedance change : Within ±30%										No mechanical damage. Inductance change : Within ±20% Qchange : Within ±30%	No mechanical damage. Inductance change : Within ±10% Qchange : Within ±30%	No mechanical damage. Inductance change : Within ±10% Qchange : Within ±20%	No mechanical damage. Inductance change : Within ±10% Qchange : Within ±20%	Conditions for 1 cycle Step 1: Minimum operating temperature +0 -3 °C 30±3 min. Step 2: Room temperature 2 to 3 min. Step 3: Maximum operating temperature +0 -3 °C 30±3 min. Step 4: Room temperature 2 to 3 min. Number of cycles: 5 Recovery : 2 to 3 hrs of recovery under the standard condition after the test. (See Note 1)						

(Note 1) When there are questions concerning measurement result ; measurement shall be made after 48 ± 2 hrs of recovery under the standard condition.

Multilayer chip inductors and beads

Item	Specified Value																			Test Methods and Remarks			
	BK0603	BK1005	BK1608	BK2125	ARRAY		BKP0603	BKP1005	BKP1608	BKP2125	CK1608	CK2125	CKP2520	LK1005	LK1608	LK2125	HK0603	HK1005	HK1608		HK2125	HKQ0603S	AQ105
					BK2010	BK3216																	
14. Damp Heat (Steady state)	Appearance : No significant abnormality. Impedance change : Within $\pm 30\%$											No mechanical damage.	No mechanical damage.	No mechanical damage.	No mechanical damage.	No mechanical damage.	No mechanical damage.	No mechanical damage. Inductance change : Within $\pm 10\%$ Q change : Within $\pm 20\%$					BBK Series : Temperature : $40 \pm 2^\circ\text{C}$ Humidity : 90 to 95%RH Duration : $500 \begin{smallmatrix} +24 \\ -0 \end{smallmatrix}$ hrs Recovery : 2 to 3 hrs of recovery under the standard condition after the removal from test chamber. (See Note 1) LK, CK, CKP, HK, HKQ, AQ Series : Temperature : $40 \pm 2^\circ\text{C}$ (LK, CK, CKP Series) $60 \pm 2^\circ\text{C}$ (HK, HKQ, AQ Series) Humidity : 90 to 95%RH Duration : $500 \pm 12$ hrs Recovery : 2 to 3 hrs of recovery under the standard condition after the removal from test chamber. (See Note 1)
15. Loading under Damp Heat	Appearance : No significant abnormality. Impedance change : Within $\pm 30\%$											No mechanical damage.	No mechanical damage.	No mechanical damage.	No mechanical damage.	No mechanical damage.	No mechanical damage.	No mechanical damage. Inductance change : Within $\pm 10\%$ Q change : Within $\pm 20\%$					BK Series : Temperature : $40 \pm 2^\circ\text{C}$ Humidity : 90 to 95%RH Duration : $500 \begin{smallmatrix} +24 \\ -0 \end{smallmatrix}$ hrs Recovery : 2 to 3 hrs of recovery under the standard condition after the removal from test chamber. (See Note 1) LK, CK, CKP, HK, HKQ, AQ Series : Temperature : $40 \pm 2^\circ\text{C}$ (LK, CK, CKP Series) $60 \pm 2^\circ\text{C}$ (HK, HKQ, AQ Series) Humidity : 90 to 95%RH Duration : $500 \pm 12$ hrs Recovery : 2 to 3 hrs of recovery under the standard condition after the removal from test chamber. (See Note 1)
16. Loading at High Temperature	Appearance : No significant abnormality. Impedance change : Within $\pm 30\%$											No mechanical damage.	No mechanical damage.	No mechanical damage.	No mechanical damage.	No mechanical damage.	No mechanical damage.	No mechanical damage. Inductance change : Within $\pm 10\%$ Q change : Within $\pm 20\%$					BK Series : Temperature : $125 \pm 3^\circ\text{C}$ Applied current : Rated current Duration : $500 \begin{smallmatrix} +24 \\ -0 \end{smallmatrix}$ hrs Recovery : 2 to 3 hrs of recovery under the standard condition after the removal from test chamber. (See Note 1) LK, CK, CKP, HK, HKQ, AQ Series, BK Series P type : Temperature : $85 \pm 2^\circ\text{C}$ (LK, CK, CKP Series) $85 \pm 3^\circ\text{C}$ (BK Series P type) $85 \pm 2^\circ\text{C}$ (HK1608, 2125) $85 \pm 2^\circ\text{C}$ (HK1005, AQ105 operating temperature range -55 to +85°C) $125 \pm 2^\circ\text{C}$ (HK0603, HK1005, HKQ0603S, AQ105 operating temperature range -55 to +125°C) Applied current : Rated current Duration : $500 \pm 12$ hrs Recovery : 2 to 3 hrs of recovery under the standard condition after the test. (See Note 1)

Note on standard condition: "standard condition" referred to herein is defined as follows:  
5 to 35°C of temperature, 45 to 85% relative humidity, and 86 to 106kPa of air pressure.

When there are questions concerning measurement results:

In order to provide correlation data, the test shall be conducted under condition of  $20 \pm 2^\circ\text{C}$  of temperature, 60 to 70% relative humidity, and 86 to 106kPa of air pressure. Unless otherwise specified, all the tests are conducted under the "standard condition."





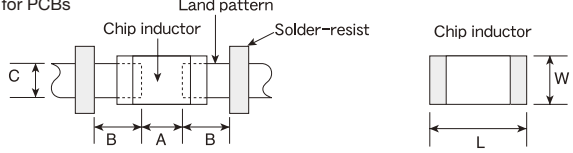
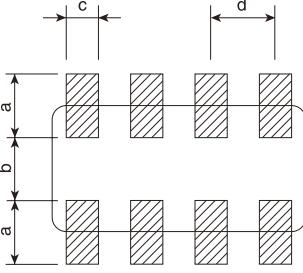

(Note 1)

measurement shall be made after  $48 \pm 2$  hrs of recovery under the standard condition.

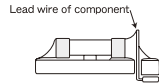
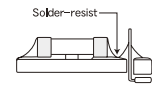
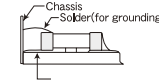
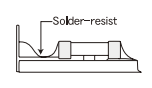
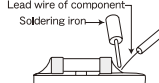
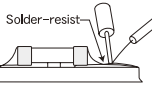
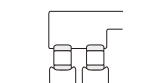
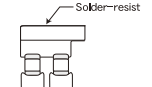
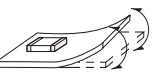
Precautions on the use of Multilayer chip Inductors, Multilayer chip inductors for high frequency, Multilayer ferrite chip beads

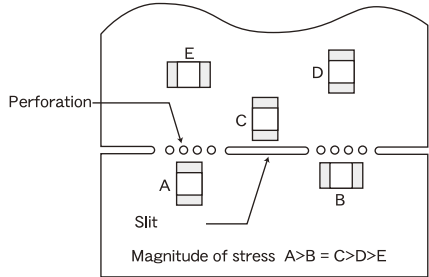
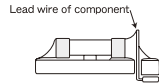
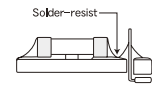
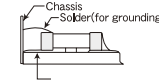
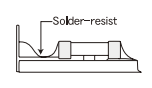
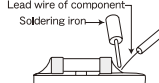
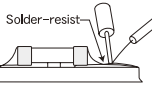
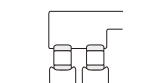
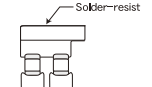
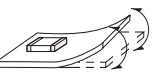
Stages	Precautions	Technical considerations																																																																																																					
1. Circuit Design	<p>◆Verification of operating environment, electrical rating and performance</p> <p>1. A malfunction in medical equipment, spacecraft, nuclear reactors, etc. may cause serious harm to human life or have severe social ramifications. As such, any inductors to be used in such equipment may require higher safety and/or reliability considerations and should be clearly differentiated from components used in general purpose applications.</p> <p>◆Operating Current (Verification of Rated current)</p> <p>1. The operating current for inductors must always be lower than their rated values.</p> <p>2. Do not apply current in excess of the rated value because the inductance may be reduced due to the magnetic saturation effect.</p>																																																																																																						
2. PCB Design	<p>◆Pattern configurations (Design of Land-patterns)</p> <p>1. When inductors are mounted on a PCB, the size of land patterns and the amount of solder used (size of fillet) can directly affect inductor performance. Therefore, the following items must be carefully considered in the design of solder land patterns:</p> <p>(1) The amount of solder applied can affect the ability of chips to withstand mechanical stresses which may lead to breaking or cracking. Therefore, when designing land-patterns it is necessary to consider the appropriate size and configuration of the solder pads which in turn determines the amount of solder necessary to form the fillets.</p> <p>(2) When more than one part is jointly soldered onto the same land or pad, the pad must be designed so that each component's soldering point is separated by solder-resist.</p> <p>(3) The larger size of land patterns and amount of solder, the smaller Q value after mounting on PCB. It makes higher the Q value to design land patterns smaller than terminal electrode of chips.</p>	<p>1. The following diagrams and tables show some examples of recommended patterns to prevent excessive solder amounts (larger fillets which extend above the component end terminations). Examples of improper pattern designs are also shown.</p> <p>(1) Recommended land dimensions for a typical chip inductor land patterns for PCBs</p>  <p>Recommended land dimensions for wave-soldering (unit: mm)</p> <table border="1" data-bbox="853 1157 1268 1343"> <thead> <tr> <th>Type</th> <th>1608</th> <th>2125</th> <th>3216</th> </tr> </thead> <tbody> <tr> <td rowspan="2">Size</td> <td>L</td> <td>1.6</td> <td>2.0</td> <td>3.2</td> </tr> <tr> <td>W</td> <td>0.8</td> <td>1.25</td> <td>1.6</td> </tr> <tr> <td>A</td> <td>0.8~1.0</td> <td>1.0~1.4</td> <td>1.8~2.5</td> </tr> <tr> <td>B</td> <td>0.5~0.8</td> <td>0.8~1.5</td> <td>0.8~1.7</td> </tr> <tr> <td>C</td> <td>0.6~0.8</td> <td>0.9~1.2</td> <td>1.2~1.6</td> </tr> </tbody> </table> <p>Recommended land dimensions for reflow-soldering (unit: mm)</p> <table border="1" data-bbox="853 1397 1460 1583"> <thead> <tr> <th>Type</th> <th>0603</th> <th>1005</th> <th>105</th> <th>1608</th> <th>2125</th> <th>3216</th> <th>2520</th> </tr> </thead> <tbody> <tr> <td rowspan="2">Size</td> <td>L</td> <td>0.6</td> <td>1.0</td> <td>1.0</td> <td>1.6</td> <td>2.0</td> <td>3.2</td> <td>2.5</td> </tr> <tr> <td>W</td> <td>0.3</td> <td>0.5</td> <td>0.6</td> <td>0.8</td> <td>1.25</td> <td>1.6</td> <td>2.0</td> </tr> <tr> <td>A</td> <td>0.20~0.30</td> <td>0.45~0.55</td> <td>0.50~0.55</td> <td>0.6~0.8</td> <td>0.8~1.2</td> <td>1.8~2.5</td> <td>1.0~1.4</td> </tr> <tr> <td>B</td> <td>0.20~0.30</td> <td>0.40~0.50</td> <td>0.30~0.40</td> <td>0.6~0.8</td> <td>0.8~1.2</td> <td>0.6~1.5</td> <td>0.6~1.0</td> </tr> <tr> <td>C</td> <td>0.25~0.40</td> <td>0.45~0.55</td> <td>0.60~0.70</td> <td>0.6~0.8</td> <td>0.9~1.6</td> <td>1.2~2.0</td> <td>1.8~2.2</td> </tr> </tbody> </table> <p>Excess solder can affect the ability of chips to withstand mechanical stresses. Therefore, please take proper precautions when designing land-patterns.</p>  <p>Recommended land dimension for Reflow-soldering (unit: mm)</p> <table border="1" data-bbox="1189 1758 1460 1976"> <thead> <tr> <th></th> <th></th> <th>3216</th> <th>2010</th> </tr> </thead> <tbody> <tr> <td rowspan="2">Size</td> <td>L</td> <td>3.2</td> <td>2.0</td> </tr> <tr> <td>W</td> <td>1.6</td> <td>1.0</td> </tr> <tr> <td>a</td> <td></td> <td>0.7~0.9</td> <td>0.5~0.6</td> </tr> <tr> <td>b</td> <td></td> <td>0.8~1.0</td> <td>0.5~0.6</td> </tr> <tr> <td>c</td> <td></td> <td>0.4~0.5</td> <td>0.2~0.3</td> </tr> <tr> <td>d</td> <td></td> <td>0.8</td> <td>0.5</td> </tr> </tbody> </table>	Type	1608	2125	3216	Size	L	1.6	2.0	3.2	W	0.8	1.25	1.6	A	0.8~1.0	1.0~1.4	1.8~2.5	B	0.5~0.8	0.8~1.5	0.8~1.7	C	0.6~0.8	0.9~1.2	1.2~1.6	Type	0603	1005	105	1608	2125	3216	2520	Size	L	0.6	1.0	1.0	1.6	2.0	3.2	2.5	W	0.3	0.5	0.6	0.8	1.25	1.6	2.0	A	0.20~0.30	0.45~0.55	0.50~0.55	0.6~0.8	0.8~1.2	1.8~2.5	1.0~1.4	B	0.20~0.30	0.40~0.50	0.30~0.40	0.6~0.8	0.8~1.2	0.6~1.5	0.6~1.0	C	0.25~0.40	0.45~0.55	0.60~0.70	0.6~0.8	0.9~1.6	1.2~2.0	1.8~2.2			3216	2010	Size	L	3.2	2.0	W	1.6	1.0	a		0.7~0.9	0.5~0.6	b		0.8~1.0	0.5~0.6	c		0.4~0.5	0.2~0.3	d		0.8	0.5
Type	1608	2125	3216																																																																																																				
Size	L	1.6	2.0	3.2																																																																																																			
	W	0.8	1.25	1.6																																																																																																			
A	0.8~1.0	1.0~1.4	1.8~2.5																																																																																																				
B	0.5~0.8	0.8~1.5	0.8~1.7																																																																																																				
C	0.6~0.8	0.9~1.2	1.2~1.6																																																																																																				
Type	0603	1005	105	1608	2125	3216	2520																																																																																																
Size	L	0.6	1.0	1.0	1.6	2.0	3.2	2.5																																																																																															
	W	0.3	0.5	0.6	0.8	1.25	1.6	2.0																																																																																															
A	0.20~0.30	0.45~0.55	0.50~0.55	0.6~0.8	0.8~1.2	1.8~2.5	1.0~1.4																																																																																																
B	0.20~0.30	0.40~0.50	0.30~0.40	0.6~0.8	0.8~1.2	0.6~1.5	0.6~1.0																																																																																																
C	0.25~0.40	0.45~0.55	0.60~0.70	0.6~0.8	0.9~1.6	1.2~2.0	1.8~2.2																																																																																																
		3216	2010																																																																																																				
Size	L	3.2	2.0																																																																																																				
	W	1.6	1.0																																																																																																				
a		0.7~0.9	0.5~0.6																																																																																																				
b		0.8~1.0	0.5~0.6																																																																																																				
c		0.4~0.5	0.2~0.3																																																																																																				
d		0.8	0.5																																																																																																				

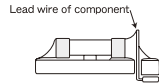
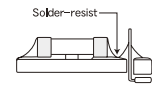
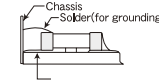
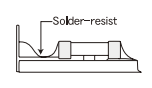
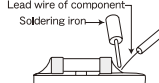
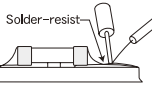
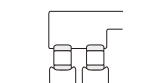
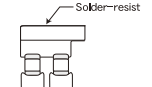
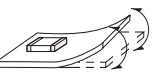
Precautions on the use of Multilayer chip Inductors, Multilayer chip inductors for high frequency, Multilayer ferrite chip beads

Stages	Precautions	Technical considerations																					
2.PCB Design	<p>◆Pattern configurations (Inductor layout on panelized [breakaway] PC boards)</p> <p>1. After inductors have been mounted on the boards, chips can be subjected to mechanical stresses in subsequent manufacturing processes (PCB cutting, board inspection, mounting of additional parts, assembly into the chassis, wave soldering the reflow soldered boards etc.) For this reason, planning pattern configurations and the position of SMD inductors should be carefully performed to minimize stress.</p>	<p>(2) Examples of good and bad solder application</p> <table border="1" data-bbox="852 299 1453 729"> <thead> <tr> <th></th> <th>Not recommended</th> <th>Recommended</th> </tr> </thead> <tbody> <tr> <td>Mixed mounting of SMD and leaded components</td> <td></td> <td></td> </tr> <tr> <td>Component placement close to the chassis</td> <td></td> <td></td> </tr> <tr> <td>Hand-soldering of leaded components near mounted components</td> <td></td> <td></td> </tr> <tr> <td>Horizontal component placement</td> <td></td> <td></td> </tr> </tbody> </table> <p>1-1. The following are examples of good and bad inductor layout; SMD inductors should be located to minimize any possible mechanical stresses from board warp or deflection.</p> <table border="1" data-bbox="852 847 1453 995"> <thead> <tr> <th>Item</th> <th>Not recommended</th> <th>Recommended</th> </tr> </thead> <tbody> <tr> <td>Deflection of the board</td> <td></td> <td></td> </tr> </tbody> </table> <p>1-2. To layout the inductors for the breakaway PC board, it should be noted that the amount of mechanical stresses given will vary depending on inductor layout. An example below should be counted for better design.</p> <div data-bbox="909 1109 1340 1386" style="text-align: center;">  <p>Magnitude of stress <math>A &gt; B = C &gt; D &gt; E</math></p> </div> <p>1-3. When breaking PC boards along their perforations, the amount of mechanical stress on the inductors can vary according to the method used. The following methods are listed in order from least stressful to most stressful: push-back, slit, V-grooving, and perforation. Thus, any ideal SMD inductor layout must also consider the PCB splitting procedure.</p>		Not recommended	Recommended	Mixed mounting of SMD and leaded components			Component placement close to the chassis			Hand-soldering of leaded components near mounted components			Horizontal component placement			Item	Not recommended	Recommended	Deflection of the board		
	Not recommended	Recommended																					
Mixed mounting of SMD and leaded components																							
Component placement close to the chassis																							
Hand-soldering of leaded components near mounted components																							
Horizontal component placement																							
Item	Not recommended	Recommended																					
Deflection of the board																							

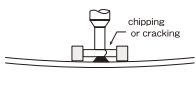
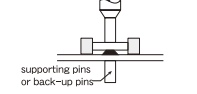
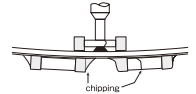
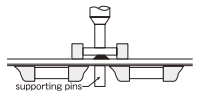
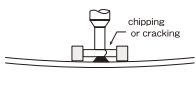
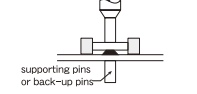
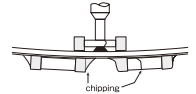
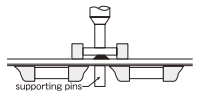
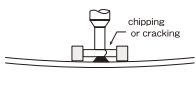
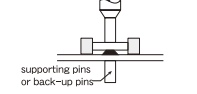
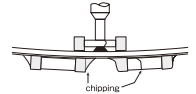
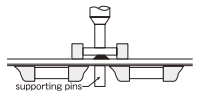

Precautions on the use of Multilayer chip Inductors, Multilayer chip inductors for high frequency, Multilayer ferrite chip beads

Stages	Precautions	Technical considerations									
<p>3.Considerations for automatic placement</p>	<p>◆Adjustment of mounting machine</p> <ol style="list-style-type: none"> <li>Excessive impact load should not be imposed on the inductors when mounting onto the PC boards.</li> <li>The maintenance and inspection of the mounter should be conducted periodically.</li> </ol> <p>◆Selection of Adhesives</p> <ol style="list-style-type: none"> <li>Mounting inductors with adhesives in preliminary assembly, before the soldering stage, may lead to degraded inductor characteristics unless the following factors are appropriately checked; the size of land patterns, type of adhesive, amount applied, hardening temperature and hardening period. Therefore, it is imperative to consult the manufacturer of the adhesives on proper usage and amounts of adhesive to use.</li> </ol>	<ol style="list-style-type: none"> <li>If the lower limit of the pick-up nozzle is low, too much force may be imposed on the inductors, causing damage. To avoid this, the following points should be considered before lowering the pick-up nozzle:             <ol style="list-style-type: none"> <li>The lower limit of the pick-up nozzle should be adjusted to the surface level of the PC board after correcting for deflection of the board.</li> <li>The pick-up pressure should be adjusted between 1 and 3 N static loads.</li> <li>To reduce the amount of deflection of the board caused by impact of the pick-up nozzle, supporting pins or back-up pins should be used under the PC board. The following diagrams show some typical examples of good pick-up nozzle placement:</li> </ol> </li> </ol> <table border="1" data-bbox="847 535 1453 805"> <thead> <tr> <th></th> <th>Improper method</th> <th>Proper method</th> </tr> </thead> <tbody> <tr> <td>Single-sided mounting</td> <td></td> <td></td> </tr> <tr> <td>Double-sided mounting</td> <td></td> <td></td> </tr> </tbody> </table> <ol style="list-style-type: none"> <li>As the alignment pin wears out, adjustment of the nozzle height can cause chipping or cracking of the inductors because of mechanical impact on the inductors. To avoid this, the monitoring of the width between the alignment pin in the stopped position, and maintenance, inspection and replacement of the pin should be conducted periodically.</li> </ol> <ol style="list-style-type: none"> <li>Some adhesives may cause reduced insulation resistance. The difference between the shrinkage percentage of the adhesive and that of the inductors may result in stresses on the inductors and lead to cracking. Moreover, too little or too much adhesive applied to the board may adversely affect component placement, so the following precautions should be noted in the application of adhesives.             <ol style="list-style-type: none"> <li>Required adhesive characteristics                 <ol style="list-style-type: none"> <li>The adhesive should be strong enough to hold parts on the board during the mounting &amp; solder process.</li> <li>The adhesive should have sufficient strength at high temperatures.</li> <li>The adhesive should have good coating and thickness consistency.</li> <li>The adhesive should be used during its prescribed shelf life.</li> <li>The adhesive should harden rapidly</li> <li>The adhesive must not be contaminated.</li> <li>The adhesive should have excellent insulation characteristics.</li> <li>The adhesive should not be toxic and have no emission of toxic gasses.</li> </ol> </li> </ol> </li> </ol>		Improper method	Proper method	Single-sided mounting			Double-sided mounting		
	Improper method	Proper method									
Single-sided mounting											
Double-sided mounting											

Precautions on the use of Multilayer chip Inductors, Multilayer chip inductors for high frequency, Multilayer ferrite chip beads

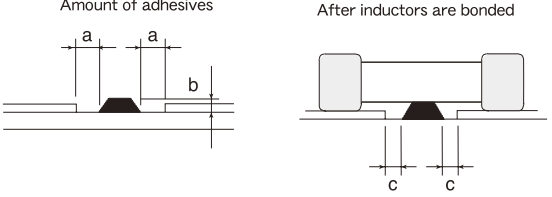
Stages	Precaution	Technical considerations								
3.Considerations for automatic placement		<p>When using adhesives to mount inductors on a PCB, inappropriate amounts of adhesive on the board may adversely affect component placement. Too little adhesive may cause the inductors to fall off the board during the solder process. Too much adhesive may cause defective soldering due excessive flow of adhesive on to the land or solder pad.</p> <p>[Recommended conditions]</p> <table border="1" data-bbox="898 447 1449 567"> <thead> <tr> <th>Figure</th> <th>0805 case sizes as examples</th> </tr> </thead> <tbody> <tr> <td>a</td> <td>0.3mm min</td> </tr> <tr> <td>b</td> <td>100 ~120 μm</td> </tr> <tr> <td>c</td> <td>Area with no adhesive</td> </tr> </tbody> </table> 	Figure	0805 case sizes as examples	a	0.3mm min	b	100 ~120 μm	c	Area with no adhesive
Figure	0805 case sizes as examples									
a	0.3mm min									
b	100 ~120 μm									
c	Area with no adhesive									
4.Soldering	<p>◆Selection of Flux</p> <ol style="list-style-type: none"> <li>Since flux may have a significant effect on the performance of inductors, it is necessary to verify the following conditions prior to use;             <ol style="list-style-type: none"> <li>Flux used should be with less than or equal to 0.1 wt% (Chlorine conversion method) of halogenated content. Flux having a strong acidity content should not be applied.</li> <li>When soldering inductors on the board, the amount of flux applied should be controlled at the optimum level.</li> <li>When using water-soluble flux, special care should be taken to properly clean the boards.</li> </ol> </li> </ol> <p>◆Soldering</p> <p>Temperature, time, amount of solder, etc. are specified in accordance with the following recommended conditions.</p>	<ol style="list-style-type: none"> <li> <ol style="list-style-type: none"> <li>When too much halogenated substance (Chlorine, etc.) content is used to activate the flux, or highly acidic flux is used, an excessive amount of residue after soldering may lead to corrosion of the terminal electrodes or degradation of insulation resistance on the surface of the Inductor.</li> <li>Flux is used to increase solderability in flow soldering, but if too much is applied, a large amount of flux gas may be emitted and may detrimentally affect solderability. To minimize the amount of flux applied, it is recommended to use a flux-bubbling system.</li> <li>Since the residue of water-soluble flux is easily dissolved by water content in the air, the residue on the surface of Inductor in high humidity conditions may cause a degradation of insulation resistance and therefore affect the reliability of the components. The cleaning methods and the capability of the machines used should also be considered carefully when selecting water-soluble flux.</li> </ol> </li> <li> <ol style="list-style-type: none"> <li>Preheating when soldering                     <p>Heating: Chip inductor components should be preheated to within 100 to 130°C of the soldering. Cooling: The temperature difference between the components and cleaning process should not be greater than 100 °C.</p> <p>Chip inductors are susceptible to thermal shock when exposed to rapid or concentrated heating or rapid cooling. Therefore, the soldering process must be conducted with a great care so as to prevent malfunction of the components due to excessive thermal shock.</p> </li> </ol> </li> </ol>								

Precautions on the use of Multilayer chip Inductors, Multilayer chip inductors for high frequency, Multilayer ferrite chip beads

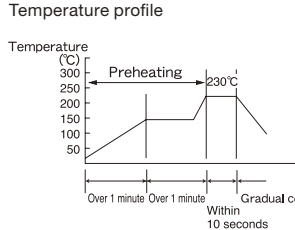
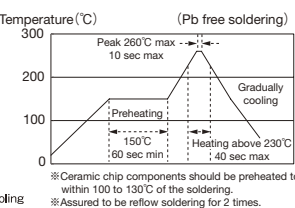
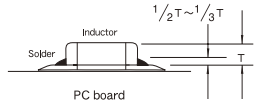
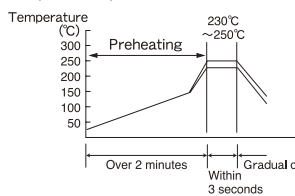
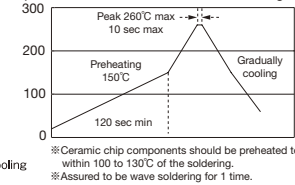
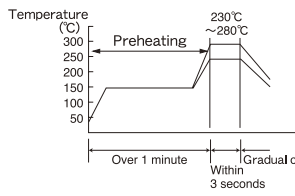
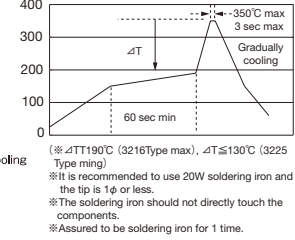
Stages	Precautions	Technical considerations
4.Soldering	<p>◆And please contact us about peak temperature when you use lead-free paste.</p>	<p>Recommended conditions for soldering</p> <p>[Reflow soldering]</p> <p>Temperature profile</p>   <p>Caution</p> <ol style="list-style-type: none"> <li>The ideal condition is to have solder mass (fillet) controlled to 1/2 to 1/3 of the thickness of the inductor, as shown below:</li> </ol>  <ol style="list-style-type: none"> <li>Because excessive dwell times can detrimentally affect solderability, soldering duration should be kept as close to recommended times as possible.</li> </ol> <p>[Wave soldering]</p> <p>Temperature profile</p>   <p>Caution</p> <ol style="list-style-type: none"> <li>Make sure the inductors are preheated sufficiently.</li> <li>The temperature difference between the inductor and melted solder should not be greater than 100 to 130°C</li> <li>Cooling after soldering should be as gradual as possible.</li> <li>Wave soldering must not be applied to the inductors designated as for reflow soldering only.</li> </ol> <p>[Hand soldering]</p> <p>Temperature profile</p>   <p>Caution</p> <ol style="list-style-type: none"> <li>Use a 20W soldering iron with a maximum tip diameter of 1.0 mm.</li> <li>The soldering iron should not directly touch the inductor.</li> </ol>
5.Cleaning	<p>◆Cleaning conditions</p> <ol style="list-style-type: none"> <li>When cleaning the PC board after the Inductors are all mounted, select the appropriate cleaning solution according to the type of flux used and purpose of the cleaning (e.g. to remove soldering flux or other materials from the production process.)</li> </ol>	<ol style="list-style-type: none"> <li>The use of inappropriate solutions can cause foreign substances such as flux residue to adhere to the inductor, resulting in a degradation of the inductor's electrical properties (especially insulation resistance).</li> </ol>

Precautions on the use of Multilayer chip Inductors, Multilayer chip inductors for high frequency, Multilayer ferrite chip beads

Stages	Precautions	Technical considerations						
5.Cleaning	<p>2. Cleaning conditions should be determined after verifying, through a test run, that the cleaning process does not affect the inductor's characteristics.</p>	<p>2. Inappropriate cleaning conditions (insufficient or excessive cleaning) may detrimentally affect the performance of the inductors.</p> <p>(1) Excessive cleaning                      In the case of ultrasonic cleaning, too much power output can cause excessive vibration of the PC board which may lead to the cracking of the inductor or the soldered portion, or decrease the terminal electrodes' strength. Thus the following conditions should be carefully checked;</p> <table border="0" style="margin-left: 40px;"> <tr> <td>Ultrasonic output</td> <td>Below 20 w/ℓ</td> </tr> <tr> <td>Ultrasonic frequency</td> <td>Below 40 kHz</td> </tr> <tr> <td>Ultrasonic washing period</td> <td>5 min. or less</td> </tr> </table>	Ultrasonic output	Below 20 w/ℓ	Ultrasonic frequency	Below 40 kHz	Ultrasonic washing period	5 min. or less
Ultrasonic output	Below 20 w/ℓ							
Ultrasonic frequency	Below 40 kHz							
Ultrasonic washing period	5 min. or less							
6. Post cleaning processes	<p>◆Application of resin coatings, moldings, etc. to the PCB and components.</p> <p>1. With some type of resins a decomposition gas or chemical reaction vapor may remain inside the resin during the hardening period or while left under normal storage conditions resulting in the deterioration of the inductor's performance.</p> <p>2. When a resin's hardening temperature is higher than the inductor's operating temperature, the stresses generated by the excess heat may lead to inductor damage or destruction.</p> <p>3. Stress caused by a resin's temperature generated expansion and contraction may damage inductors.</p> <p>The use of such resins, molding materials etc. is not recommended.</p>							
7. Handling	<p>◆Breakaway PC boards (splitting along perforations)</p> <p>1. When splitting the PC board after mounting inductors and other components, care is required so as not to give any stresses of deflection or twisting to the board.</p> <p>2. Board separation should not be done manually, but by using the appropriate devices.</p> <p>◆General handling precautions</p> <ol style="list-style-type: none"> <li>1. Always wear static control bands to protect against ESD.</li> <li>2. Keep the inductors away from all magnets and magnetic objects.</li> <li>3. Use non-magnetic tweezers when handling inductors.</li> <li>4. Any devices used with the inductors (soldering irons, measuring instruments) should be properly grounded.</li> <li>5. Keep bare hands and metal products (i.e., metal desk) away from chip electrodes or conductive areas that lead to chip electrodes.</li> <li>6. Keep inductors away from items that generate magnetic fields such as speakers or coils.</li> </ol> <p>◆Mechanical considerations</p> <ol style="list-style-type: none"> <li>1. Be careful not to subject the inductors to excessive mechanical shocks.                     <ol style="list-style-type: none"> <li>(1) If inductors are dropped on the floor or a hard surface they should not be used.</li> <li>(2) When handling the mounted boards, be careful that the mounted components do not come in contact with or bump against other boards or components.</li> </ol> </li> </ol>							

Precautions on the use of Multilayer chip Inductors, Multilayer chip inductors for high frequency, Multilayer ferrite chip beads

Stages	Precautions	Technical considerations
8. Storage conditions	<p>◆Storage</p> <p>1. To maintain the solderability of terminal electrodes and to keep the packaging material in good condition, care must be taken to control temperature and humidity in the storage area. Humidity should especially be kept as low as possible.</p> <p>Recommended conditions                      Ambient temperature                      Below 40 °C                      Humidity    Below 70% RH</p> <p>The ambient temperature must be kept below 30 °C. Even under ideal storage conditions inductor electrode solderability decreases as time passes, so inductors should be used within 6 months from the time of delivery.</p> <p>*The packaging material should be kept where no chlorine or sulfur exists in the air.</p>	<p>1. If the parts are stocked in a high temperature and humidity environment, problems such as reduced solderability caused by oxidation of terminal electrodes and deterioration of taping/packaging materials may take place. For this reason, components should be used within 6 months from the time of delivery. If exceeding the above period, please check solderability before using the inductors</p>