

2-Mbit (128K x 16) Static RAM

Features

- **High speed**
 - 55 ns
- **Temperature Ranges**
 - Industrial: -40°C to 85°C
 - Automotive: -40°C to 125°C
- **Wide voltage range**
 - 2.7V – 3.6V
- **Ultra-low active, standby power**
- **Easy memory expansion with \overline{CE} and \overline{OE} features**
- **TTL-compatible inputs and outputs**
- **Automatic power-down when deselected**
- **CMOS for optimum speed/power**
- **Available in a Pb-free and non Pb-free 44-pin TSOP Type II (forward pinout) and 48-ball FBGA packages**

Functional Description^[1]

The CY62136V is a high-performance CMOS static RAM organized as 128K words by 16 bits. This device features advanced circuit design to provide ultra-low active current.

This is ideal for providing More Battery Life™ (MoBL[®]) in portable applications such as cellular telephones. The device also has an automatic power-down feature that significantly reduces power consumption by 99% when addresses are not toggling. The device can also be put into standby mode when deselected (\overline{CE} HIGH). The input/output pins (I/O₀ through I/O₁₅) are placed in a high-impedance state when: deselected (\overline{CE} HIGH), outputs are disabled (\overline{OE} HIGH), \overline{BHE} and \overline{BLE} are disabled (\overline{BHE} , \overline{BLE} HIGH), or during a write operation (\overline{CE} LOW, and \overline{WE} LOW).

Writing to the device is accomplished by taking Chip Enable (\overline{CE}) and Write Enable (\overline{WE}) inputs LOW. If Byte Low Enable (\overline{BLE}) is LOW, then data from I/O pins (I/O₀ through I/O₇), is written into the location specified on the address pins (A₀ through A₁₆). If Byte High Enable (\overline{BHE}) is LOW, then data from I/O pins (I/O₈ through I/O₁₅) is written into the location specified on the address pins (A₀ through A₁₆).

Reading from the device is accomplished by taking Chip Enable (\overline{CE}) and Output Enable (\overline{OE}) LOW while forcing the Write Enable (\overline{WE}) HIGH. If Byte Low Enable (\overline{BLE}) is LOW, then data from the memory location specified by the address pins will appear on I/O₀ to I/O₇. If Byte High Enable (\overline{BHE}) is LOW, then data from memory will appear on I/O₈ to I/O₁₅. See the Truth Table at the back of this data sheet for a complete description of read and write modes.

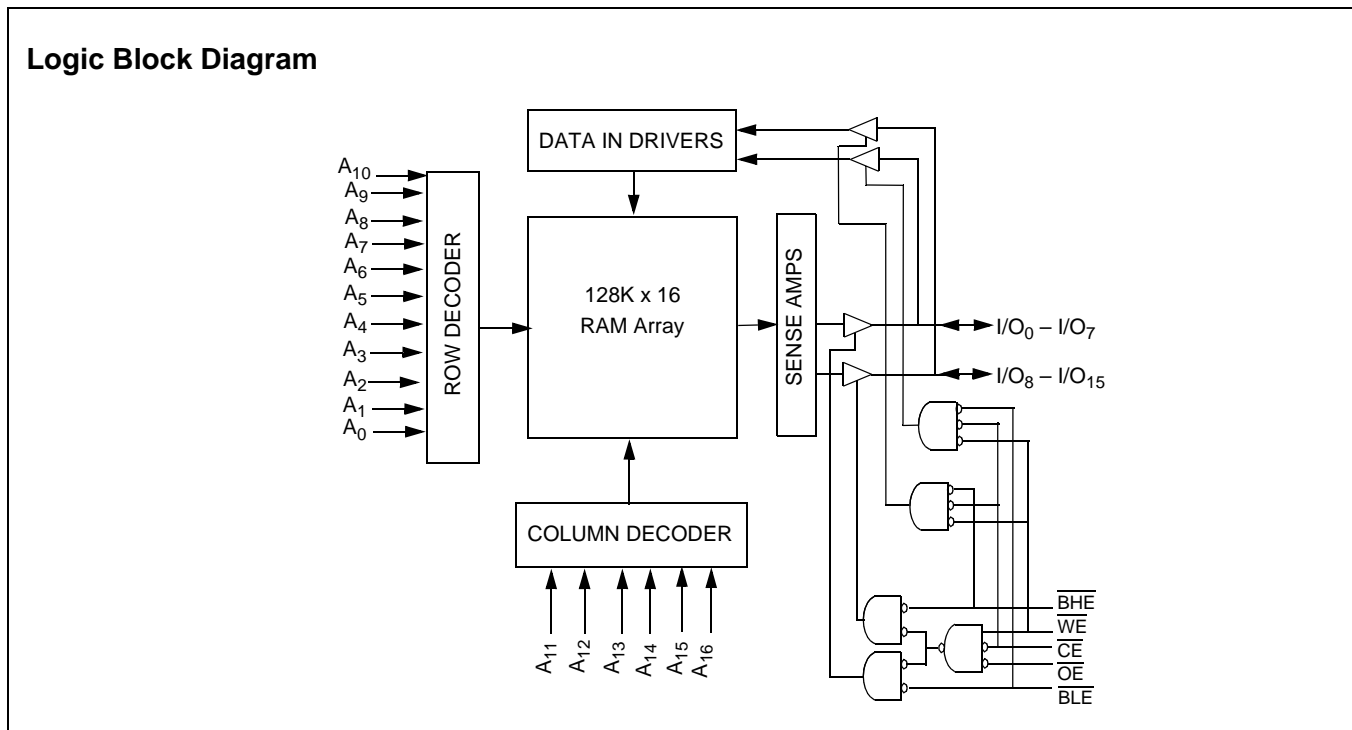

Note:

1. For best practice recommendations, please refer to the Cypress application note "System Design Guidelines" on <http://www.cypress.com>.

Product Portfolio

Product	V _{CC} Range (V)			Speed	Grades	Power Dissipation (Industrial)			
	Min.	Typ. ^[2]	Max.			Operating, I _{CC} (mA)		Standby, I _{SB2} (μA)	
						Typ. ^[2]	Maximum	Typ. ^[2]	Maximum
CY62136VLL	2.7	3.0	3.6	55	Industrial	7	20	1	15
				70	Industrial	7	15	1	15
					Automotive	7	20	1	20

Pin Configurations^[3, 4]

TSOP II (Forward)
Top View

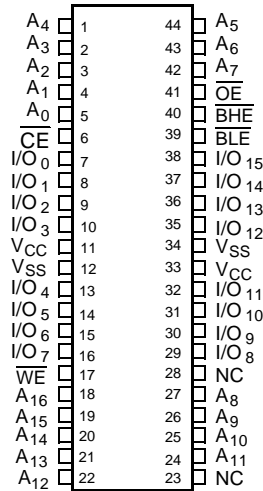

48-ball FBGA
Top View

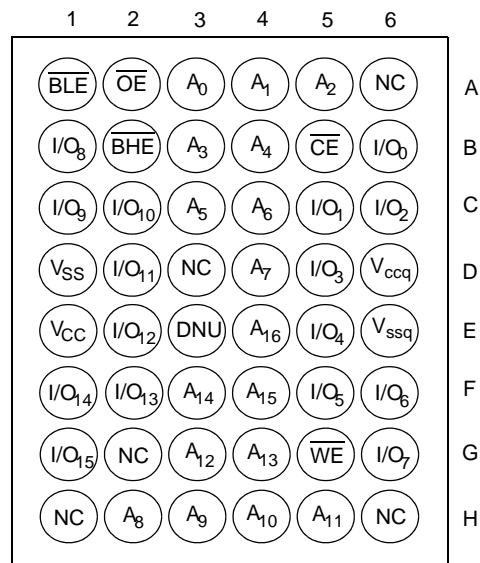

Notes:

- Typical values are included for reference only and are not guaranteed or tested. Typical values are measured at V_{CC} = V_{CC} Typ, T_A = 25°C.
- NC pins are not connected on the die.
- E3 (DNU) pin have to be left floating or tied to V_{SS} to ensure proper operation.

Pin Definitions

Pin Number	Type	Description
1–5, 18–22, 24–27, 42–45	Input	A₀–A₁₆ . Address Inputs
7–10, 13–16, 29–32, 35–38	Input/Output	I/O₀–I/O₁₅ . Data lines. Used as input or output lines depending on operation
23	No Connect	NC . This pin is not connected to the die
17	Input/Control	\overline{WE} . When selected LOW, a WRITE is conducted. When selected HIGH, a READ is conducted
6	Input/Control	\overline{CE} . When LOW, selects the chip. When HIGH, deselects the chip
40, 39	Input/Control	\overline{BHE}, \overline{BLE} . \overline{BHE} = LOW selects higher order byte WRITES or READs on the SRAM \overline{BLE} = LOW selects lower order byte WRITES or READs on the SRAM
41	Input/Control	\overline{OE} . Output Enable. Controls the direction of the I/O pins. When LOW, the I/O pins behave as outputs. When deasserted HIGH, I/O pins are Tri-stated, and act as input data pins
12, 34	Ground	V_{SS} . Ground for the device
11, 33	Power Supply	V_{CC} . Power supply for the device

Maximum Ratings

(Above which the useful life may be impaired. For user guidelines, not tested.)

Storage Temperature	-65°C to +150°C
Ambient Temperature with Power Applied.....	-55°C to +125°C
Supply Voltage to Ground Potential	-0.5V to +4.6V
DC Voltage Applied to Outputs in High-Z State ^[5]	-0.5V to $V_{CC} + 0.5V$
DC Input Voltage ^[5]	-0.5V to $V_{CC} + 0.5V$

Output Current into Outputs (LOW).....	20 mA
Static Discharge Voltage.....	> 2001V (per MIL-STD-883, Method 3015)
Latch-up Current.....	> 200 mA

Operating Range

Range	Ambient Temperature [T_A] ^[7]	V_{CC}
Industrial	-40°C to +85°C	2.7V to 3.6V
Automotive	-40°C to +125°C	

Electrical Characteristics Over the Operating Range

Parameter	Description	Test Conditions	CY62136V-55			CY62136V-70			Unit
			Min.	Typ. ^[2]	Max.	Min.	Typ. ^[2]	Max.	
V_{OH}	Output HIGH Voltage	$I_{OH} = -1.0 \text{ mA}$, $V_{CC} = 2.7V$	2.4			2.4			V
V_{OL}	Output LOW Voltage	$I_{OL} = 2.1 \text{ mA}$, $V_{CC} = 2.7V$			0.4			0.4	V
V_{IH}	Input HIGH Voltage	$V_{CC} = 3.6V$	2.2		$V_{CC} + 0.5V$	2.2		$V_{CC} + 0.5V$	V
V_{IL}	Input LOW Voltage	$V_{CC} = 2.7V$	-0.5		0.8	-0.5		0.8	V
I_{IX}	Input Leakage Current	$GND \leq V_I \leq V_{CC}$	Industrial	-1	+1	-1	+1	μA	
			Automotive			-10	+10	μA	
I_{OZ}	Output Leakage Current	$GND \leq V_O \leq V_{CC}$, Output Disabled	Industrial	-1	+1	-1	+1	μA	
			Automotive			-10	+10	μA	
I_{CC}	V_{CC} Operating Supply Current	$f = f_{Max} = 1/t_{RC}$, $V_{CC} = 3.6V$, $I_{OUT} = 0 \text{ mA}$, CMOS Levels	Industrial		7	20	7	15	mA
			Automotive				7	20	mA
				1	2	1	2	mA	
I_{SB1}	Automatic CE Power-down Current—CMOS Inputs	$\overline{CE} \geq V_{CC} - 0.3V$, $V_{IN} \geq V_{CC} - 0.3V$ or $V_{IN} \leq 0.3V$, $f = f_{Max}$			100			100	μA
I_{SB2}	Automatic CE Power-down Current—CMOS Inputs	$\overline{CE} \geq V_{CC} - 0.3V$, $V_{IN} \geq V_{CC} - 0.3V$ or $V_{IN} \leq 0.3V$, $f = 0$, $V_{CC} = 3.6V$	Industrial		1	15	1	15	μA
			Automotive				1	20	μA

Capacitance^[6]

Parameter	Description	Test Conditions	Max.	Unit
C_{IN}	Input Capacitance	$T_A = 25^\circ\text{C}$, $f = 1 \text{ MHz}$, $V_{CC} = V_{CC}(\text{typ})$	6	pF
C_{OUT}	Output Capacitance		8	pF

Thermal Resistance^[6]

Parameter	Description	Test Conditions	FBGA	TSOPII	Unit
Θ_{JA}	Thermal Resistance (Junction to Ambient)	Still Air, soldered on a 4.25 x 1.125 inch, 2-layer printed circuit board	41.17	60	$^\circ\text{C/W}$
Θ_{JC}	Thermal Resistance (Junction to Case)		11.74	22	$^\circ\text{C/W}$

Notes:

- $V_{IL}(\text{min}) = -2.0V$ for pulse durations less than 20 ns.
- Tested initially and after any design or process changes that may affect these parameters.
- T_A is the "Instant-On" case temperature.

AC Test Loads and Waveforms

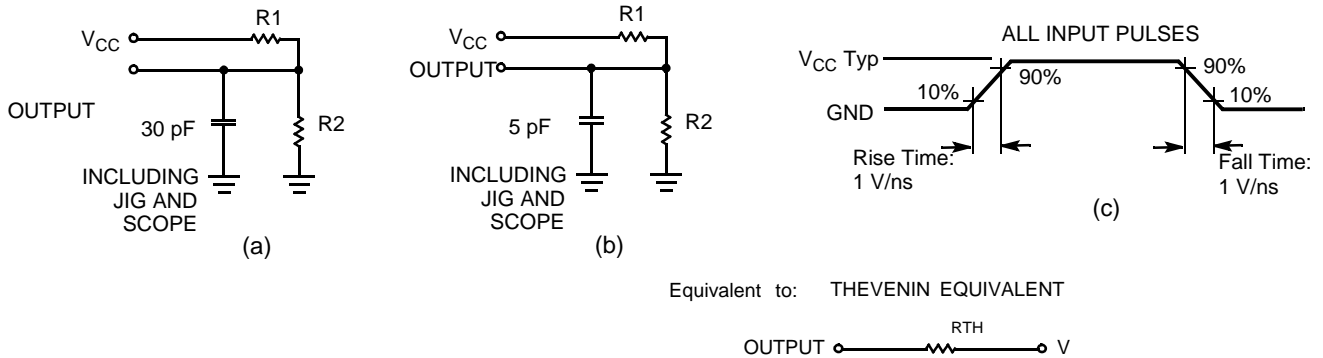

Parameters	3.0V	Unit
R1	1105	Ohms
R2	1550	Ohms
R_{TH}	645	Ohms
V_{TH}	1.75	Volts

Data Retention Characteristics (Over the Operating Range)

Parameter	Description	Conditions ^[9]	Min.	Typ. ^[2]	Max.	Unit
V_{DR}	V_{CC} for Data Retention		1.0		3.6	V
I_{CCDR}	Data Retention Current	$V_{CC} = 1.0V$, $\overline{CE} \geq V_{CC} - 0.3V$, $V_{IN} \geq V_{CC} - 0.3V$ or $V_{IN} \leq 0.3V$, No input may exceed $V_{CC} + 0.3V$		0.5	7.5	μA
$t_{CDR}^{[6]}$	Chip Deselect to Data Retention Time		0			ns
$t_R^{[8]}$	Operation Recovery Time		70			ns

Data Retention Waveform

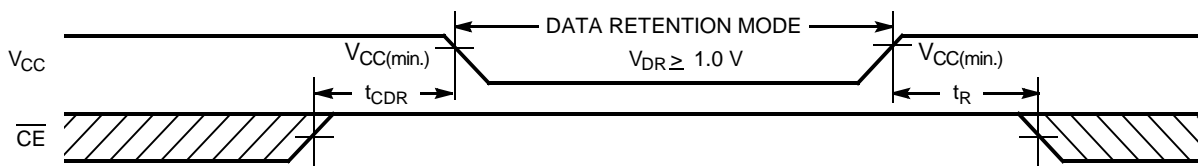

Notes:

8. Full device operation requires linear V_{CC} ramp from V_{DR} to $V_{CC(min)} \geq 100 \mu s$ or stable at $V_{CC(min)} \geq 100 \mu s$.

9. Test conditions assume signal transition time of 5 ns or less, timing reference levels of 1.5V, input pulse levels of 0 to $V_{CC(typ.)}$, and output loading of the specified I_{OL}/I_{OH} and 30 pF load capacitance.

Switching Characteristics Over the Operating Range ^[9]

Parameter	Description	55 ns		70 ns		Unit
		Min.	Max.	Min.	Max.	
Read Cycle						
t _{RC}	Read Cycle Time	55		70		ns
t _{AA}	Address to Data Valid		55		70	ns
t _{OHA}	Data Hold from Address Change	10		10		ns
t _{ACE}	$\overline{\text{CE}}$ LOW to Data Valid		55		70	ns
t _{DOE}	$\overline{\text{OE}}$ LOW to Data Valid		25		35	ns
t _{LZOE}	$\overline{\text{OE}}$ LOW to Low-Z ^[10]	5		5		ns
t _{HZOE}	$\overline{\text{OE}}$ HIGH to High-Z ^[10, 11]		25		25	ns
t _{LZCE}	$\overline{\text{CE}}$ LOW to Low-Z ^[10]	10		10		ns
t _{HZCE}	$\overline{\text{CE}}$ HIGH to High-Z ^[10, 11]		25		25	ns
t _{PU}	$\overline{\text{CE}}$ LOW to Power-up	0		0		ns
t _{PD}	$\overline{\text{CE}}$ HIGH to Power-down		55		70	ns
t _{DBE}	$\overline{\text{BLE}}/\overline{\text{BHE}}$ LOW to Data Valid		25		35	ns
t _{LZBE}	$\overline{\text{BLE}}/\overline{\text{BHE}}$ LOW to Low-Z ^[10, 11]	5		5		ns
t _{HZBE}	$\overline{\text{BLE}}/\overline{\text{BHE}}$ HIGH to High-Z ^[12]		25		25	ns
Write Cycle ^[12, 13]						
t _{WC}	Write Cycle Time	55		70		ns
t _{SCE}	$\overline{\text{CE}}$ LOW to Write End	45		60		ns
t _{AW}	Address Set-up to Write End	45		60		ns
t _{HA}	Address Hold from Write End	0		0		ns
t _{SA}	Address Set-up to Write Start	0		0		ns
t _{PWE}	$\overline{\text{WE}}$ Pulse Width	40		50		ns
t _{BW}	$\overline{\text{BLE}}/\overline{\text{BHE}}$ LOW to Write End	50		60		ns
t _{SD}	Data Set-up to Write End	25		30		ns
t _{HD}	Data Hold from Write End	0		0		ns
t _{HZWE}	$\overline{\text{WE}}$ LOW to High-Z ^[10, 11]		20		25	ns
t _{LZWE}	$\overline{\text{WE}}$ HIGH to Low-Z ^[10]	5		10		ns

Notes:

10. At any given temperature and voltage condition, t_{HZCE} is less than t_{LZCE}, t_{HZOE} is less than t_{LZOE}, and t_{HZWE} is less than t_{LZWE} for any given device.

11. t_{HZOE}, t_{HZCE}, and t_{HZWE} are specified with C_L = 5 pF as in (b) of AC Test Loads. Transition is measured ±500 mV from steady-state voltage.

12. The internal write time of the memory is defined by the overlap of $\overline{\text{CE}}$ LOW and $\overline{\text{WE}}$ LOW. Both signals must be LOW to initiate a write and either signal can terminate a write by going HIGH. The data input set-up and hold timing should be referenced to the rising edge of the signal that terminates the write.

13. The minimum write cycle time for write cycle 3 ($\overline{\text{WE}}$ controlled, $\overline{\text{OE}}$ LOW) is the sum of t_{HZWE} and t_{SD}.

Switching Waveforms

Read Cycle No. 1 (Address Transition Controlled)^[14, 15]

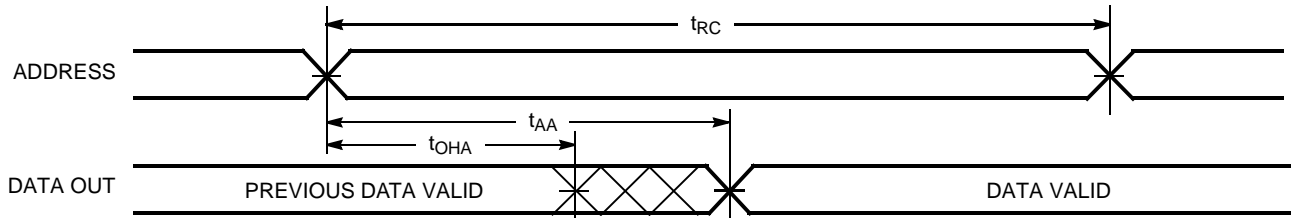

Read Cycle No. 2 (\overline{OE} Controlled)^[15, 16]

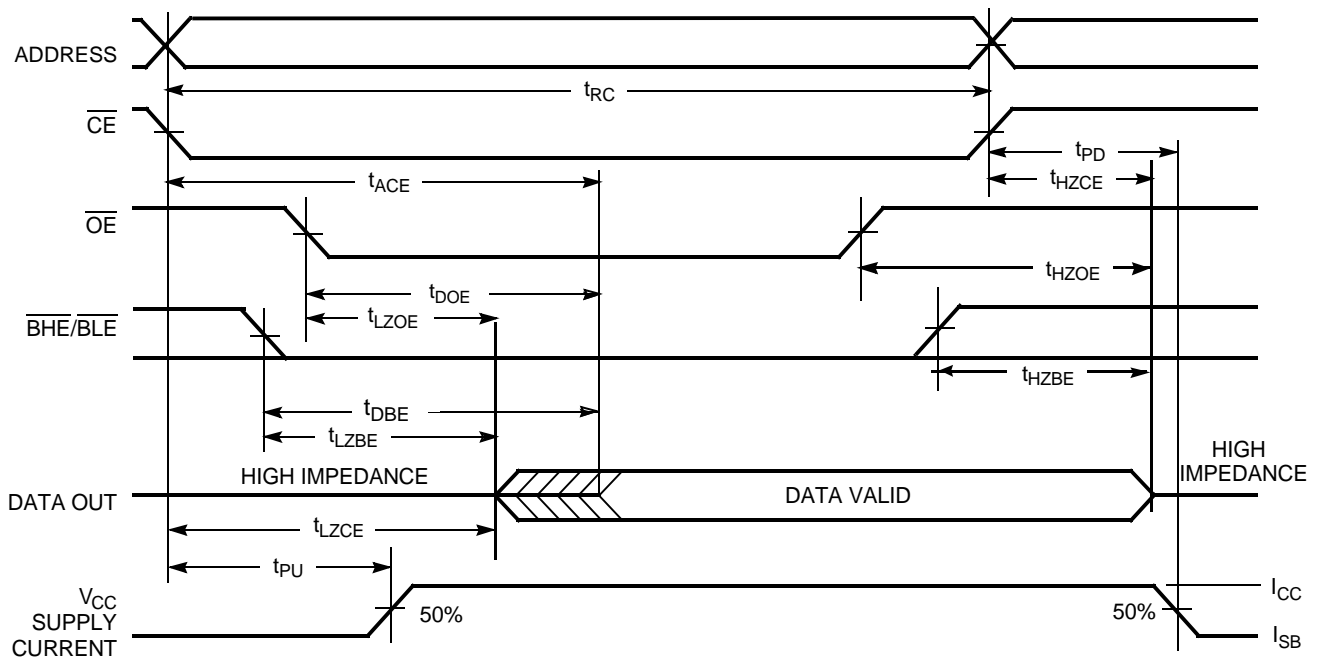

Notes:

- 14. Device is continuously selected. \overline{OE} , $\overline{CE} = V_{IL}$.
- 15. WE is HIGH for read cycle.
- 16. Address valid prior to or coincident with \overline{CE} transition LOW.

Switching Waveforms (continued)

Write Cycle No. 1 (WE Controlled)^[12, 17, 18]

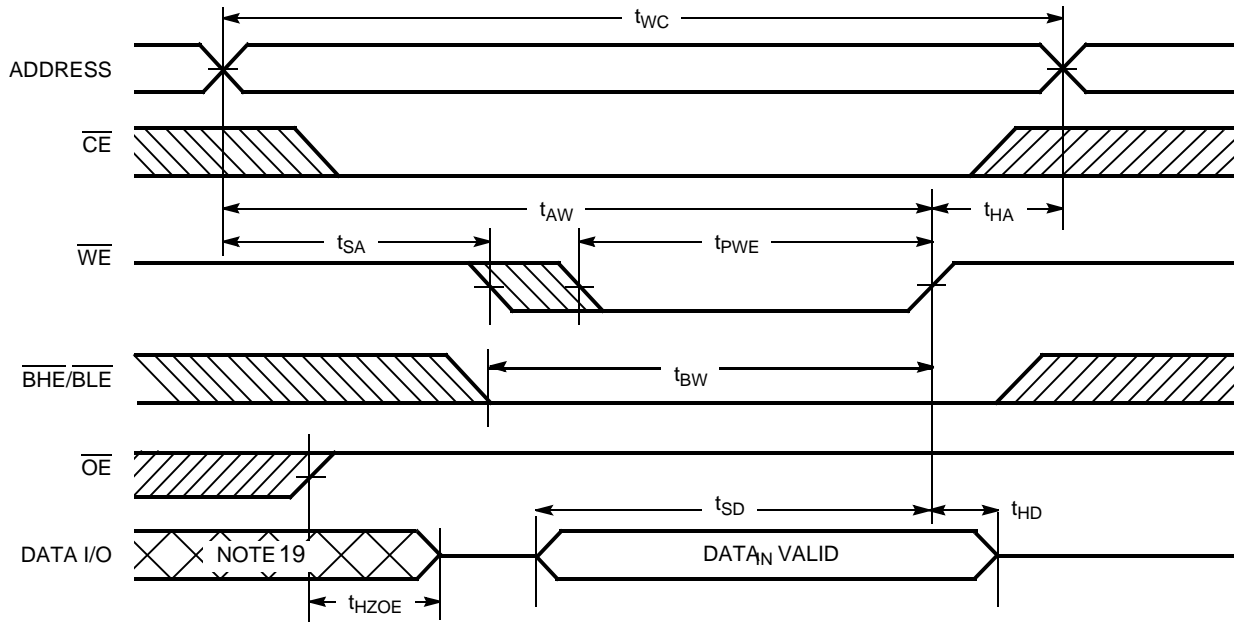

Write Cycle No. 2 (CE Controlled)^[12, 17, 18]

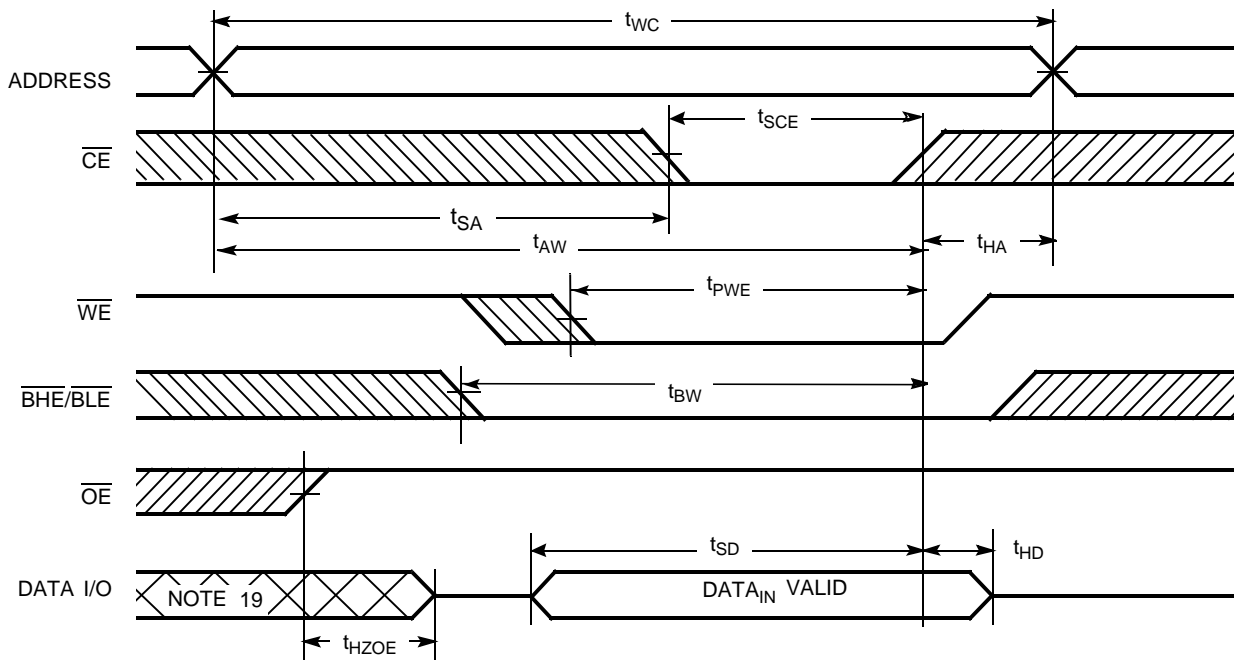

Notes:

- 17. Data I/O is high impedance if $\overline{OE} = V_{IH}$.
- 18. If \overline{CE} goes HIGH simultaneously with WE HIGH, the output remains in a high-impedance state.
- 19. During this period, the I/Os are in output state and input signals should not be applied.

Switching Waveforms (continued)

Write Cycle No. 3 ($\overline{\text{WE}}$ Controlled, $\overline{\text{OE}}$ LOW)^[13, 18]

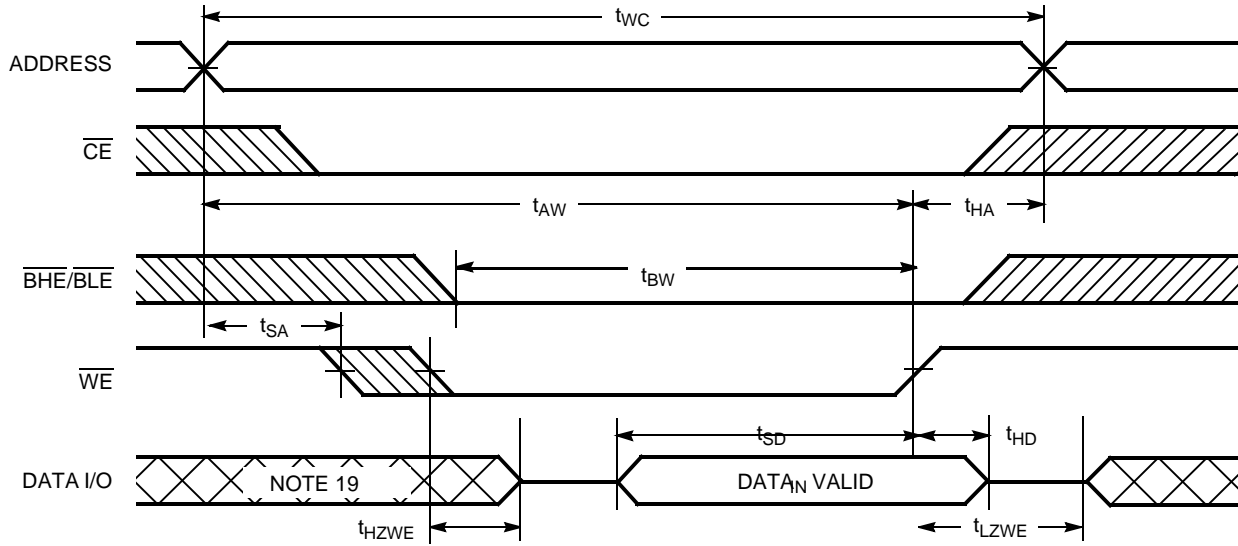

Write Cycle No. 4 ($\overline{\text{BHE/BLE}}$ Controlled, $\overline{\text{OE}}$ LOW)^[19]

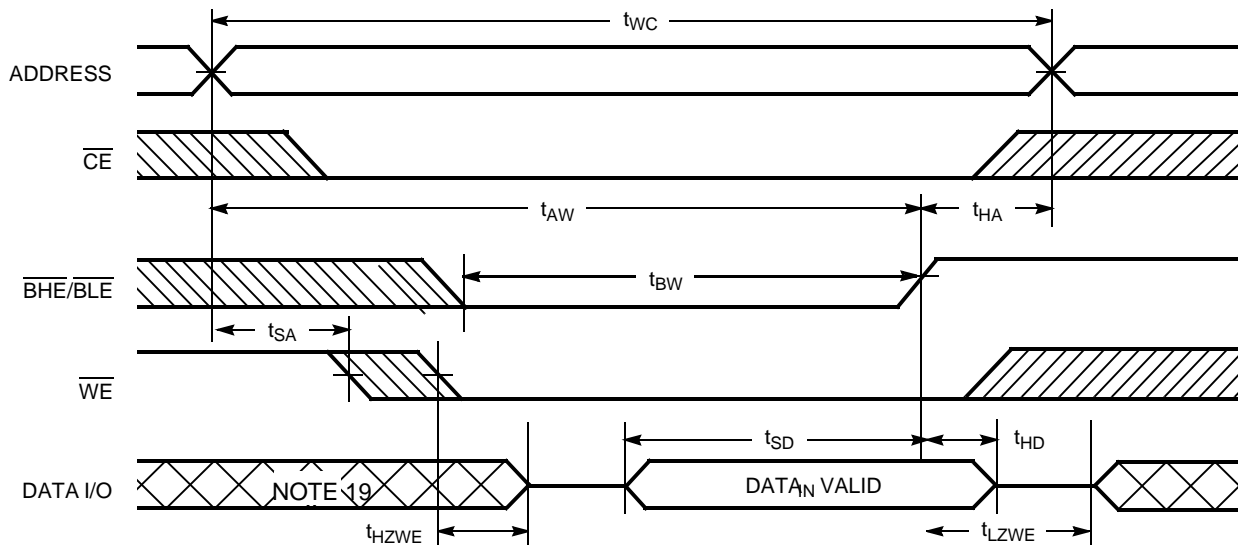

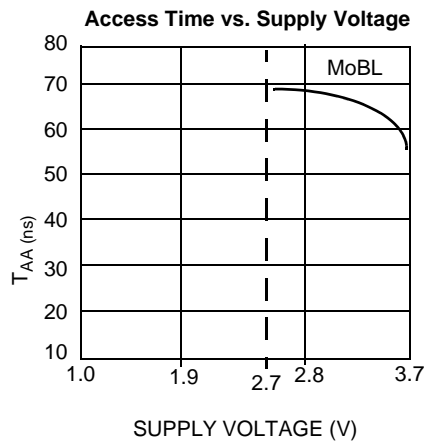
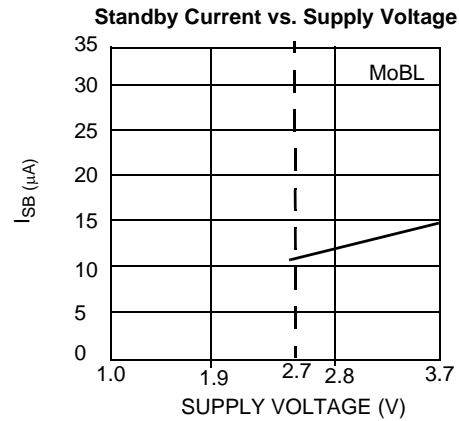
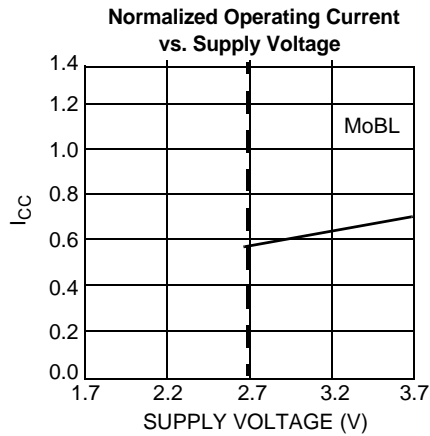
Typical DC and AC Characteristics

Truth Table

\overline{CE}	\overline{WE}	\overline{OE}	\overline{BHE}	\overline{BLE}	Inputs/Outputs	Mode	Power
H	X	X	X	X	High-Z	Deselect/Power-down	Standby (I_{SB})
L	H	L	L	L	Data Out (I/O_0 - I/O_{15})	Read	Active (I_{CC})
L	H	L	H	L	High Z (I/O_8 - I/O_{15}); Data Out (I/O_0 - I/O_7)	Read	Active (I_{CC})
L	H	L	L	H	Data Out (I/O_8 - I/O_{15}); High Z (I/O_0 - I/O_7)	Read	Active (I_{CC})
L	L	X	L	L	Data In (I/O_0 - I/O_{15})	Write	Active (I_{CC})
L	L	X	H	L	High Z (I/O_8 - I/O_{15}); Data In (I/O_0 - I/O_7)	Write	Active (I_{CC})
L	L	X	L	H	Data in (I/O_8 - I/O_{15}); High Z (I/O_0 - I/O_7)	Write	Active (I_{CC})
L	H	L	H	H	High-Z	Deselect/Output Disabled	Active (I_{CC})
L	H	H	L	L	High-Z	Deselect/Output Disabled	Active (I_{CC})
L	H	H	H	L	High-Z	Deselect/Output Disabled	Active (I_{CC})
L	H	H	L	H	High-Z	Deselect/Output Disabled	Active (I_{CC})

Ordering Information

Speed (ns)	Ordering Code	Package Diagram	Package Type	Operating Range
55	CY62136VLL-55BAI	51-85096	48-ball Fine-Pitch Ball Grid Array (7 x 7 x 1.2 mm)	Industrial
	CY62136VLL-55ZI	51-85087	44-pin TSOP II	
	CY62136VLL-55ZXI		44-pin TSOP II (Pb-free)	
70	CY62136VLL-70BAI	51-85096	48-ball Fine-Pitch Ball Grid Array (7 x 7 x 1.2 mm)	Industrial
	CY62136VLL-70ZI	51-85087	44-pin TSOP II	
	CY62136VLL-70ZXI		44-pin TSOP II (Pb-free)	
	CY62136VLL-70ZSE		44-pin TSOP II	Automotive
	CY62136VLL-70ZSXE		44-pin TSOP II (Pb-free)	

Please contact your local Cypress sales representative for availability of these parts

Package Diagrams

48-ball FBGA (7 x 7 x 1.2 mm) (51-85096)

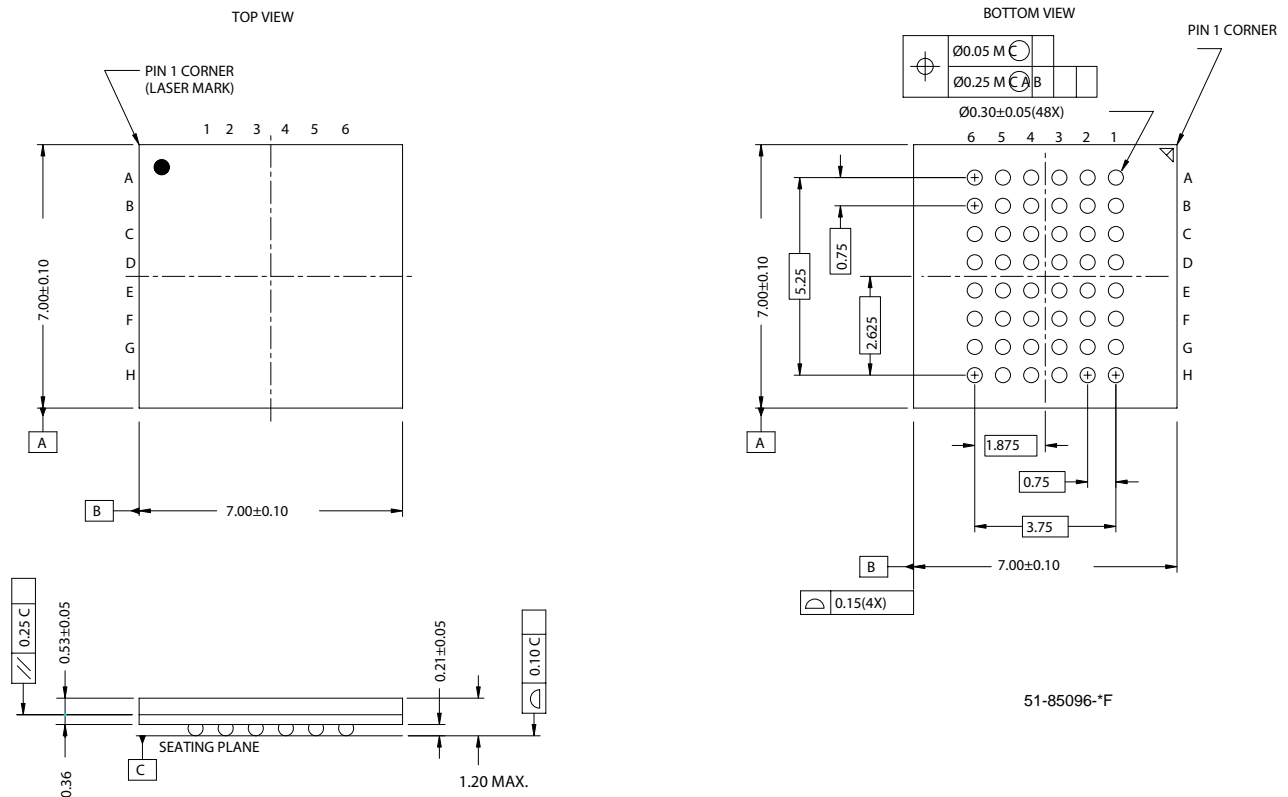

Package Diagrams (continued)

44-pin TSOP II (51-85087)

DIMENSION IN MM (INCH)
MAX
MIN

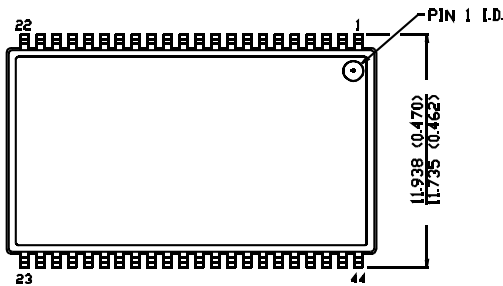

TOP VIEW

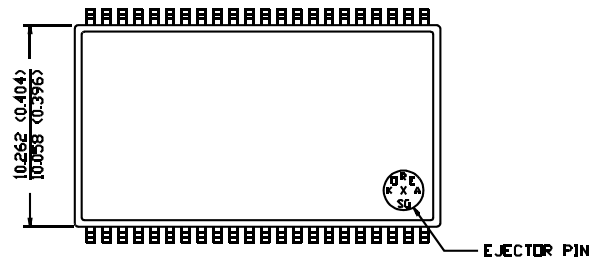

BOTTOM VIEW

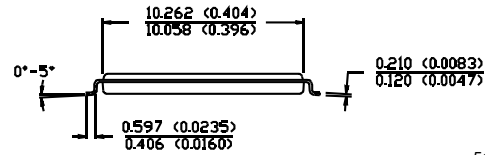
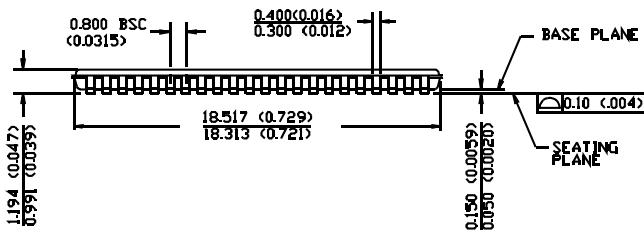

51-85087-A

MoBL is a registered trademark, and More Battery Life is a trademark, of Cypress Semiconductor Corporation. All product and company names mentioned in this document are the products of their respective holders.

Document History Page

Document Title: CY62136V MoBL® 2-Mbit (128K x 16) Static RAM				
Document Number: 38-05087				
REV.	ECN NO.	Issue Date	Orig. of Change	Description of Change
**	107347	05/25/01	SZV	Changed from Spec #: 38-00728 to 38-05087
*A	116509	09/04/02	GBI	Added footnote 1 Added SL power bin Deleted fBGA package; replacement fBGA package available in CY62136CV30
*B	269729	See ECN	SYT	Added Automotive Information for 70-ns Speed Bin. Added Footnotes # 3 and # 6. Corrected Typo in Electrical Characteristics for I _{CC} (Max)-55 ns from 15 to 20 mA. Added SL row for I _{SB2} in the Electrical Characteristics table. Changed Package Name from Z44 to ZS44. Replaced 'Z' with 'ZS' in the Ordering Code.
*C	344595	See ECN	SYT	Added Lead-Free Package on page# 9 Changed Package Name from ZS44 to Z44 for the 44 TSOP II Package Replaced 'ZS' with 'Z' in the Ordering Code for Industrial
*D	486789	See ECN	VKN	Changed address of Cypress Semiconductor Corporation on Page# 1 from "3901 North First Street" to "198 Champion Court". Added FBGA Package for Industrial Operating range. Removed SL Power bin. Updated Ordering Information table.