

8-/10-/12-Bit, Octal-Channel, Ultra-Low Glitch, Voltage Output, Two-Wire Interface Digital-to-Analog Converters

 Check for Samples: [DAC5578](#), [DAC6578](#), [DAC7578](#)

FEATURES

- **Relative Accuracy:**
 - **DAC5578 (8 bit): 0.25LSB INL**
 - **DAC6578 (10 bit): 0.5LSB INL**
 - **DAC7578 (12 bit): 1LSB INL**
- **Glitch Energy: 0.15nV-s**
- **Power-On Reset to Zero Scale or Midscale**
 - **Devices in the TSSOP Package Reset to Zero Scale**
 - **Devices in the QFN Package Reset to Zero Scale or Midscale**
- **Ultra-Low Power Operation: 0.13mA/ch at 5V**
- **Wide Power-Supply Range: +2.7V to +5.5V**
- **2-Wire Serial Interface (I²C™ compatible)**
- **Temperature Range: –40°C to +125°C**

APPLICATIONS

- **Portable Instrumentation**
- **Closed-Loop Servo Control**
- **Process Control**
- **Data Acquisition Systems**

DESCRIPTION

The DAC5578 (8 bit), DAC6578 (10 bit), and DAC7578 (12 bit) are low-power, voltage-output, octal channel, digital-to-analog converters (DACs). The devices are monolithic, provide good linearity, and minimize undesired code-to-code transient voltages (glitch).

The devices use a versatile, 2-wire serial interface that is I²C-compatible and operates at clock rates of up to 3.4MHz. Multiple devices can share the same bus.

The devices incorporate a power-on-reset (POR) circuit that ensures the DAC output powers up to zero-scale or midscale until a valid code is written to the device. These devices also contain a power-down feature, accessed through the serial interface, that reduces the current consumption of the devices to typically 0.42µA at 5V. Power consumption is typically 2.32mW at 3V, reducing to 0.68µW in power-down mode. The low power consumption and small footprint make these devices ideal for portable, battery-operated equipment.

The [DAC5578](#), [DAC6578](#), and [DAC7578](#) are drop-in and functionally-compatible with the [DAC7678](#). All devices are available in a 4x4, QFN-24 package and a TSSOP-16 package.

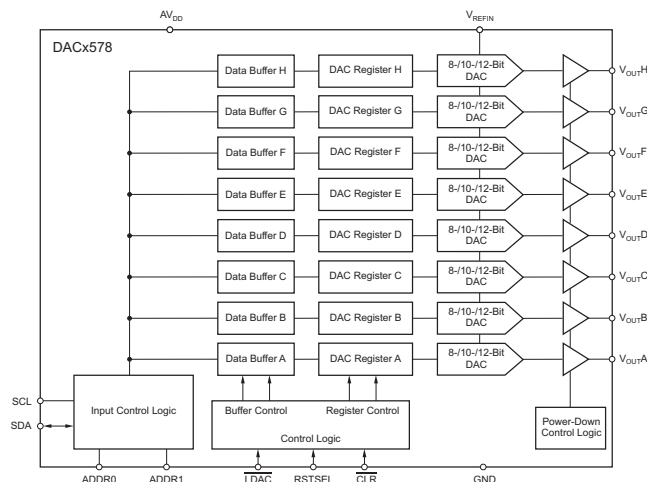

RELATED DEVICES	8-BIT	10-BIT	12-BIT
Pin- and Function-Compatible (w/internal reference)	—	—	DAC7678
Pin- and Function-Compatible	DAC5578	DAC6578	DAC7578



Please be aware that an important notice concerning availability, standard warranty, and use in critical applications of Texas Instruments semiconductor products and disclaimers thereto appears at the end of this data sheet.

I²C is a trademark of NXP Semiconductors.

All other trademarks are the property of their respective owners.



This integrated circuit can be damaged by ESD. Texas Instruments recommends that all integrated circuits be handled with appropriate precautions. Failure to observe proper handling and installation procedures can cause damage.

ESD damage can range from subtle performance degradation to complete device failure. Precision integrated circuits may be more susceptible to damage because very small parametric changes could cause the device not to meet its published specifications.

PACKAGE/ORDERING INFORMATION⁽¹⁾

PRODUCT	MAXIMUM RELATIVE ACCURACY (LSB)	MAXIMUM DIFFERENTIAL NONLINEARITY (LSB)	PACKAGE-LEAD	PACKAGE DESIGNATOR	SPECIFIED TEMPERATURE RANGE	PACKAGE MARKING
DAC7578	±1	±0.25	TSSOP-16	PW	–40°C to +125°C	DAC7578
			QFN-24	RGE		DAC7578
DAC6578	±0.5	±0.5	TSSOP-16	PW	–40°C to +125°C	DAC6578
			QFN-24	RGE		DAC6578
DAC5578	±0.25	±0.25	TSSOP-16	PW	–40°C to +125°C	DAC5578
			QFN-24	RGE		DAC5578

(1) For the most current package and ordering information see the Package Option Addendum at the end of this document, or see the TI web site at www.ti.com.

ABSOLUTE MAXIMUM RATINGS⁽¹⁾

Over operating free-air temperature range, unless otherwise noted.

	DAC5578, DAC6578, DAC7578	UNIT
AV _{DD} to GND	–0.3 to +6	V
Digital input voltage to GND	–0.3 to +AV _{DD} + 0.3	V
V _{OUT} to GND	–0.3 to +AV _{DD} + 0.3	V
V _{REFIN} to GND	–0.3 to +AV _{DD} + 0.3	V
Operating temperature range	–40 to +125	°C
Storage temperature range	–65 to +150	°C
Junction temperature range (T _J max)	+150	°C
Power dissipation	(T _J max – T _A)/θ _{JA}	W

(1) Stresses above those listed under *Absolute Maximum Ratings* may cause permanent damage to the device. Exposure to absolute maximum conditions for extended periods may affect device reliability.

THERMAL INFORMATION

THERMAL METRIC ⁽¹⁾		DACx578		UNITS
		PW (16 Pins)	RGE (24 PINS)	
θ _{JA}	Junction-to-ambient thermal resistance	111.9	33.7	°C/W
θ _{JCtop}	Junction-to-case (top) thermal resistance	33.3	16.9	
θ _{JB}	Junction-to-board thermal resistance	52.4	7.4	
ψ _{JT}	Junction-to-top characterization parameter	2	0.5	
ψ _{JB}	Junction-to-board characterization parameter	51.2	7.1	
θ _{JCbot}	Junction-to-case (bottom) thermal resistance	n/a	1.7	

(1) For more information about traditional and new thermal metrics, see the *IC Package Thermal Metrics* application report, [SPRA953](http://www.ti.com/lit/zip/spra953).

ELECTRICAL CHARACTERISTICS

 At $V_{DD} = 2.7V$ to $5.5V$ and over $-40^{\circ}C$ to $+125^{\circ}C$, unless otherwise noted.

PARAMETER		TEST CONDITIONS	DAC5578, DAC6578, DAC7578			UNIT
			MIN	TYP	MAX	
STATIC PERFORMANCE⁽¹⁾						
DAC5578	Resolution		8			Bits
	Relative accuracy	Measured by the line passing through codes 4 and 250		± 0.01	± 0.25	LSB
	Differential nonlinearity			± 0.01	± 0.25	LSB
DAC6578	Resolution		10			Bits
	Relative accuracy	Measured by the line passing through codes 12 and 1012		± 0.06	± 0.5	LSB
	Differential nonlinearity			± 0.03	± 0.5	LSB
DAC7578	Resolution		12			Bits
	Relative accuracy	Measured by the line passing through codes 30 and 4050		± 0.3	± 1	LSB
	Differential nonlinearity			± 0.1	± 0.25	LSB
Offset error	Extrapolated from two-point line passing through two codes ⁽²⁾ , unloaded		0.5	± 4	mV	
Offset error drift			3		$\mu V/^{\circ}C$	
Full-scale error	DAC register loaded with all '1's		± 0.03	± 0.2	% of FSR	
Full-scale error drift			2		$\mu V/^{\circ}C$	
Zero-code error	DAC register loaded with all '0's		1	4	mV	
Zero-code error drift			2		$\mu V/^{\circ}C$	
Gain error	Extrapolated from two-point line passing through two codes ⁽²⁾ , unloaded		± 0.01	± 0.15	% of FSR	
Gain temperature coefficient			± 1		ppm of FSR/ $^{\circ}C$	
OUTPUT CHARACTERISTICS⁽³⁾						
Output voltage range			0	V_{DD}	V	
Output voltage settling time	DACs unloaded, 1/4 scale to 3/4 scale		7			μs
	$R_L = 1M\Omega$ and $C_L = 470pF$		12			μs
Slew rate			0.75			V/ μs
Capacitive load stability	$R_L = \infty$		470			pF
	$R_L = 2k\Omega$		1000			pF
Code change glitch impulse	1LSB change around major carry		0.15			nV-s
Digital feedthrough	SCL toggling		1.5			nV-s
Power-on glitch	$R_L = \infty$		3			mV
Channel-to-channel dc crosstalk	Full-scale swing on adjacent channel		0.1			LSB
DC output impedance	At midscale input		4.5			Ω
Short-circuit current	DAC outputs shorted to GND		25			mA
Power-up time (including settling time)	Coming out of power-down mode, $V_{DD} = 5V$		50			μs

(1) Linearity calculated using a reduced code range; output unloaded.

(2) 12-bit: 30 and 4050; 10-bit: 12 and 1012; 8-bit: 4 and 250

(3) Specified by design or characterization; not production tested.

ELECTRICAL CHARACTERISTICS (continued)

At $AV_{DD} = 2.7V$ to $5.5V$ and over $-40^{\circ}C$ to $+125^{\circ}C$, unless otherwise noted.

PARAMETER		TEST CONDITIONS	DAC5578, DAC6578, DAC7578			UNIT
			MIN	TYP	MAX	
AC PERFORMANCE⁽⁴⁾						
DAC output noise density		$T_A = +25^{\circ}C$, at zero-code input, $f_{OUT} = 1kHz$	20			nV/\sqrt{Hz}
DAC output noise		$T_A = +25^{\circ}C$, at midscale input, $f = 0.1Hz$ to $10Hz$	3			μV_{PP}
EXTERNAL REFERENCE						
External reference current		$AV_{DD} = 2.7V$ to $5.5V$	60			μA
LOGIC INPUTS⁽⁴⁾						
Input current			± 1			μA
V_{INL}	Logic input LOW voltage	$2.7V \leq AV_{DD} \leq 5.5V$	GND-0.3	$0.3 \times AV_{DD}$		V
V_{INH}	Logic input HIGH voltage	$2.7V \leq AV_{DD} \leq 5.5V$	$0.7 \times AV_{DD}$	$AV_{DD} + 0.3$		V
Pin capacitance			1.5	3		pF
POWER REQUIREMENTS						
AV_{DD}	Analog power supply		2.7	5.5		V
I_{DD} ⁽⁵⁾	Normal mode	$AV_{DD} = 3.6V$ to $5.5V$ $V_{INH} = AV_{DD}$ and $V_{INL} = GND$	1.02	1.4		mA
		$AV_{DD} = 2.7V$ to $3.6V$ $V_{INH} = AV_{DD}$ and $V_{INL} = GND$	0.86	1.3		mA
	All power-down modes	$AV_{DD} = 3.6V$ to $5.5V$ $V_{INH} = AV_{DD}$ and $V_{INL} = GND$	0.42	6		μA
		$AV_{DD} = 2.7V$ to $3.6V$ $V_{INH} = AV_{DD}$ and $V_{INL} = GND$	0.25	4.7		μA
Power dissipation ⁽⁵⁾	Normal mode	$AV_{DD} = 3.6V$ to $5.5V$ $V_{INH} = AV_{DD}$ and $V_{INL} = GND$	3.67	7.7		mW
		$AV_{DD} = 2.7V$ to $3.6V$ $V_{INH} = AV_{DD}$ and $V_{INL} = GND$	2.32	4.68		mW
	All power-down modes	$AV_{DD} = 3.6V$ to $5.5V$ $V_{INH} = AV_{DD}$ and $V_{INL} = GND$	1.51	33		μW
		$AV_{DD} = 2.7V$ to $3.6V$ $V_{INH} = AV_{DD}$ and $V_{INL} = GND$	0.68	16.92		μW
TEMPERATURE RANGE						
Specified performance			-40	+125		$^{\circ}C$

(4) Specified by design or characterization; not production tested.

(5) Input code = mid scale, no load.

PIN CONFIGURATIONS

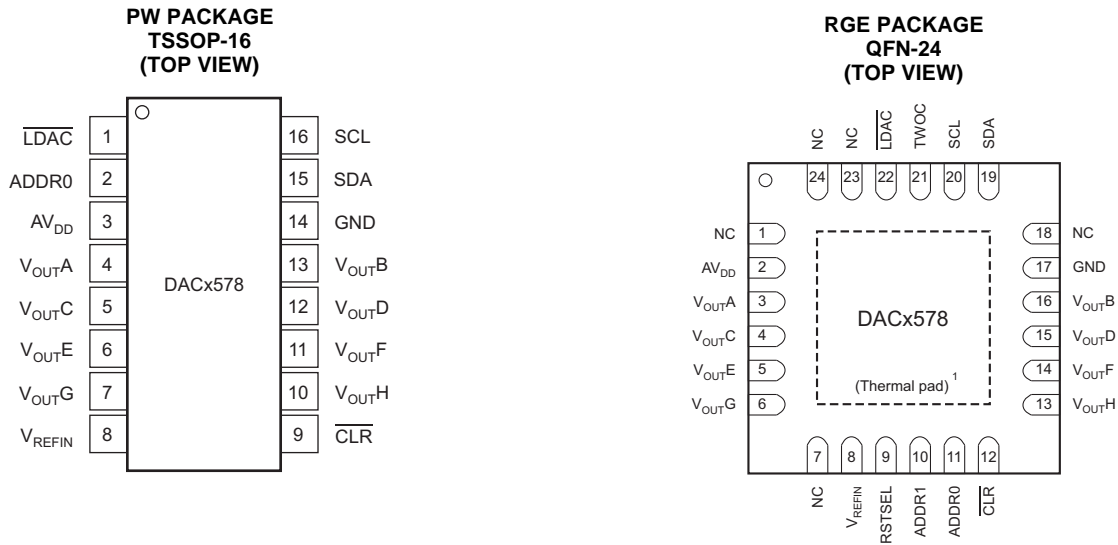

- (1) It is recommended to connect the thermal pad to GND for better thermal dissipation.

PIN DESCRIPTIONS

PACKAGE		NAME	DESCRIPTION
16-Pin	24-PIN		
1	22	$\overline{\text{LDAC}}$	Load DACs
2	11	ADDR0	3-state address input
3	2	AV_{DD}	Power-supply input, 2.7V to 5.5V
4	3	V_{OUTA}	Analog output voltage from DAC A
5	4	V_{OUTC}	Analog output voltage from DAC C
6	5	V_{OUTE}	Analog output voltage from DAC E
7	6	V_{OUTG}	Analog output voltage from DAC G
8	8	V_{REFIN}	Positive reference input
9	12	$\overline{\text{CLR}}$	Asynchronous clear input
10	13	V_{OUTH}	Analog output voltage from DAC H
11	14	V_{OUTF}	Analog output voltage from DAC F
12	15	V_{OUTD}	Analog output voltage from DAC D
13	16	V_{OUTB}	Analog output voltage from DAC B
14	17	GND	Ground reference point for all circuitry on the device
15	19	SDA	Serial data input. Data are clocked into or out of the input register. This pin is a bidirectional, open-drain data line that should be connected to the supply voltage with an external pull-up resistor.
16	20	SCL	Serial clock input. Data can be transferred at rates up to 3.4MHz. Schmitt-trigger logic input.
—	1	NC	Not internally connected
—	7	NC	Not internally connected
—	9	RSTSEL	Reset select pin. RSTSEL high resets device to mid-scale; RSTSEL low resets device to zero-scale.
—	10	ADDR1	3-state address input
—	18	NC	Not internally connected
—	21	TWOC	Twos complement select. If the TWOC pin is pulled high, the DAC registers use twos complement format; if TWOC is pulled low, the DAC registers use straight binary format.
—	23	NC	Not internally connected
—	24	NC	Not internally connected

TIMING DIAGRAM

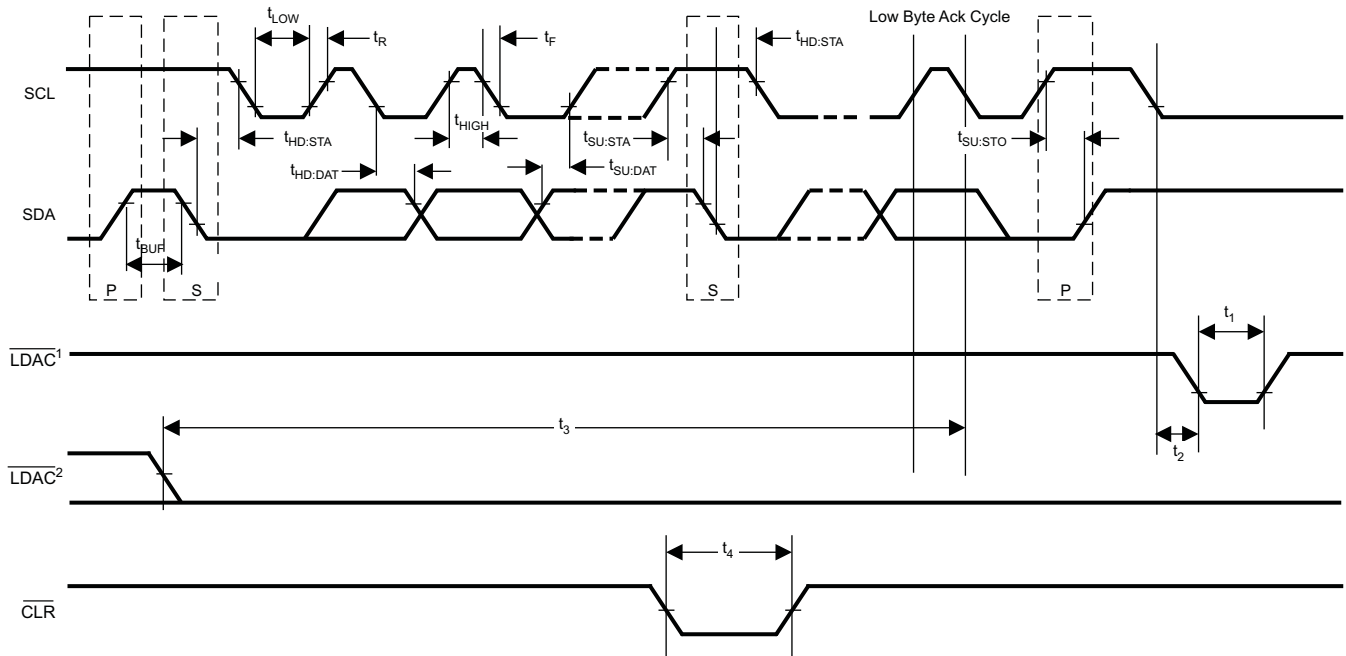

- (1) Asynchronous LDAC update mode. For more information and details, see the *LDAC Functionality* section.
- (2) Synchronous LDAC update mode. For more information and details, see the *LDAC Functionality* section.

Figure 1. Serial Write Operation

TIMING REQUIREMENTS⁽¹⁾

At $V_{DD} = 2.7\text{ V to }5.5\text{ V}$ and $-40^\circ\text{C to }+125^\circ\text{C}$ range (unless otherwise noted).

PARAMETER	STANDARD MODE		FAST MODE		HIGH SPEED MODE		UNIT
	MIN	MAX	MIN	MAX	MIN	MAX	
SCL frequency, f_{SCL}	0.1		0.4		3.4		MHz
Bus free time between STOP and START conditions, t_{BUF}	4.7		1.3				μs
Hold time after repeated start, $t_{HD:STA}$	4		0.6		0.16		μs
Repeated Start setup time, $t_{SU:STA}$	4.7		0.6		0.16		μs
STOP condition setup time, $t_{SU:STO}$	4		0.6		0.16		μs
Data hold time, $t_{HD:DAT}$	0		0		0		ns
Data setup time, $t_{SU:DAT}$	250		100		10		ns
SCL clock LOW period, t_{LOW}	4700		1300		160		ns
SCL clock HIGH period, t_{HIGH}	4000		600		60		ns
Clock/Data fall time, t_F	300		300		160		ns
Clock/Data rise time, t_R	1000		300		160		ns
LDAC pulse width LOW time, t_1	40		10		1.2		μs
SCL falling edge to LDAC falling edge for asynchronous LDAC update, t_2	20		5		0.6		μs
LDAC falling edge to SCL falling edge for synchronous LDAC update, t_3	360		90		10.5		μs
CLR pulse width LOW time, t_4	40		10		1.2		μs

- (1) See the Serial Write Operation timing diagram.

TYPICAL CHARACTERISTICS: DAC at $V_{DD} = 5.5\text{ V}$

At $T_A = 25^\circ\text{C}$, external reference used, DAC output not loaded, and all DAC codes in straight binary data format, DAC7578 graphs shown (unless otherwise noted).

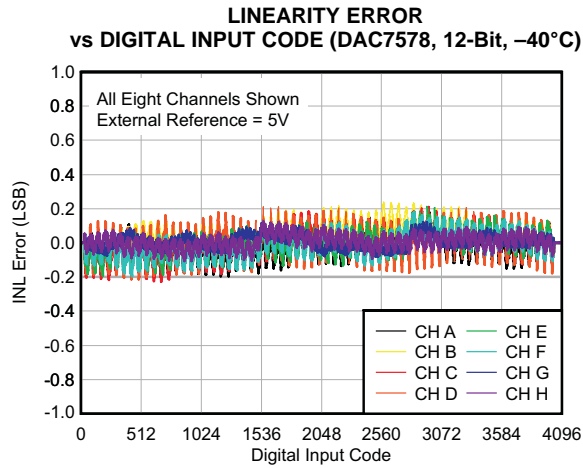

Figure 2.

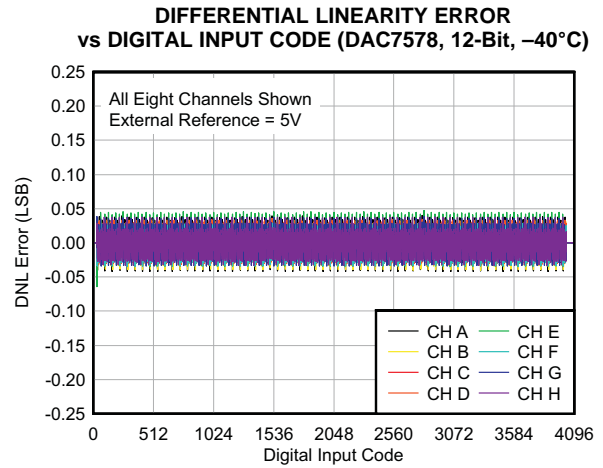

Figure 3.

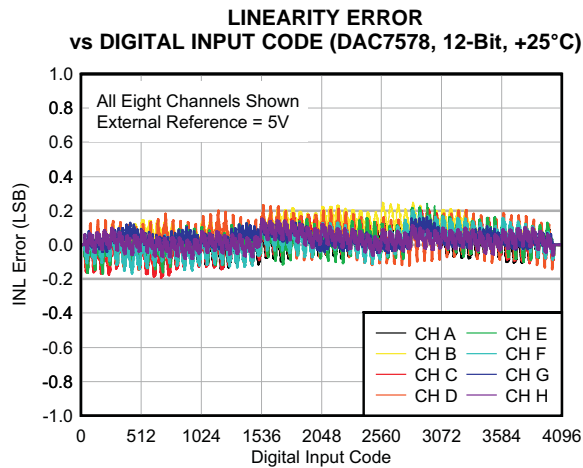

Figure 4.

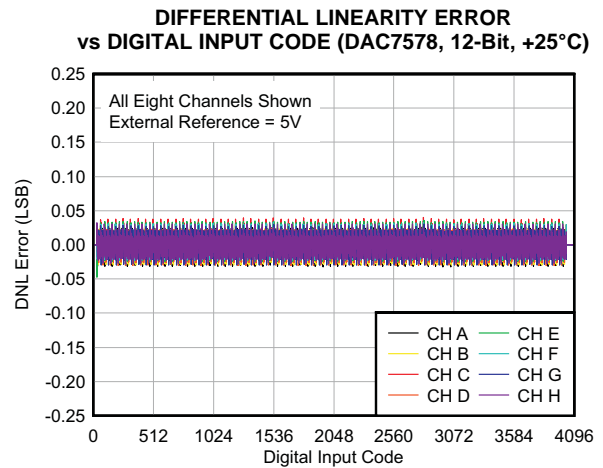

Figure 5.

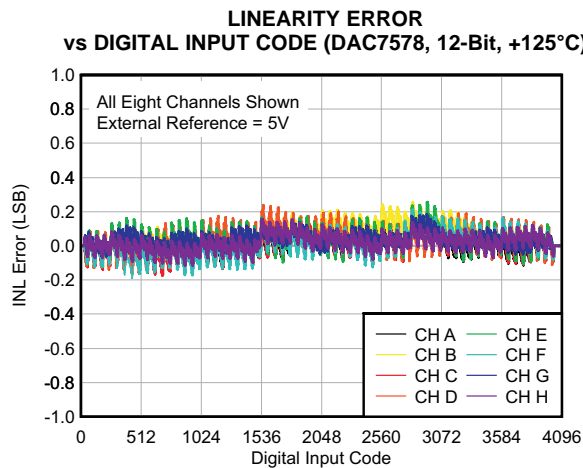

Figure 6.

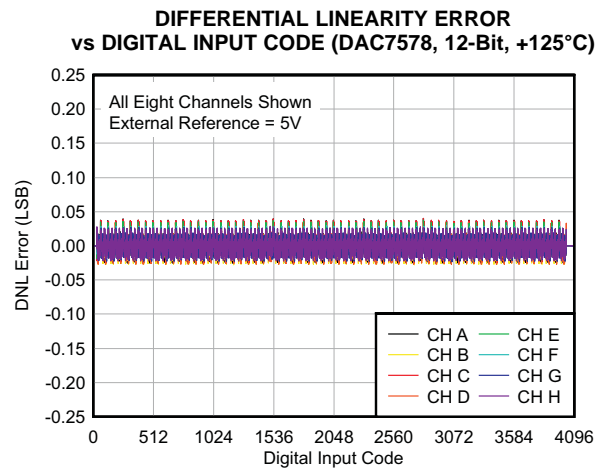

Figure 7.

TYPICAL CHARACTERISTICS: DAC at $V_{DD} = 5.5\text{ V}$ (continued)

At $T_A = 25^\circ\text{C}$, external reference used, DAC output not loaded, and all DAC codes in straight binary data format, DAC7578 graphs shown (unless otherwise noted).

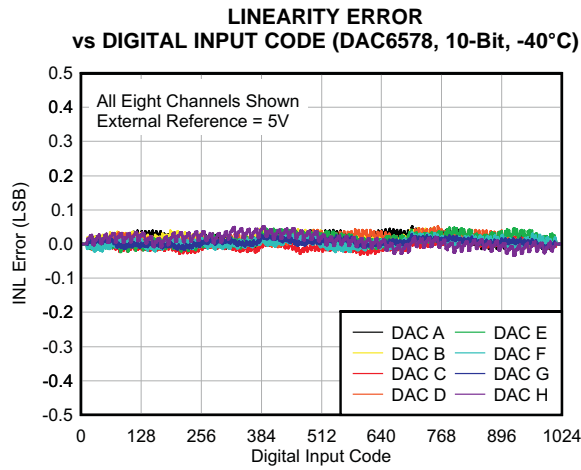

Figure 8.

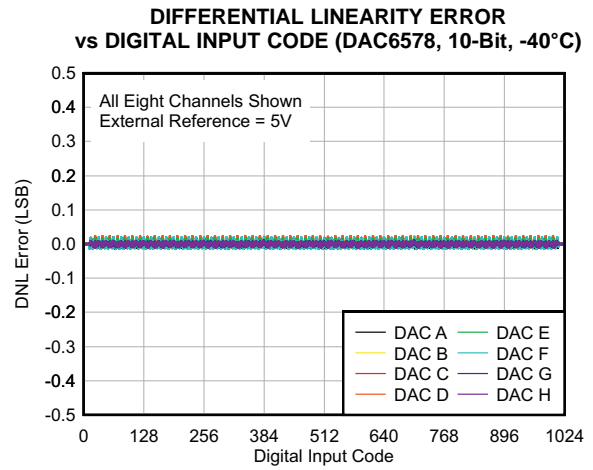

Figure 9.

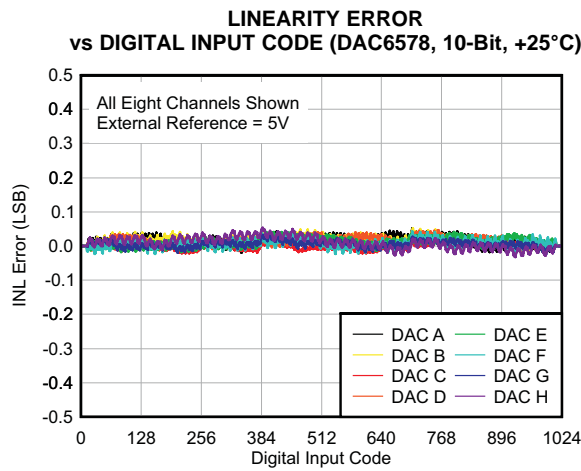

Figure 10.

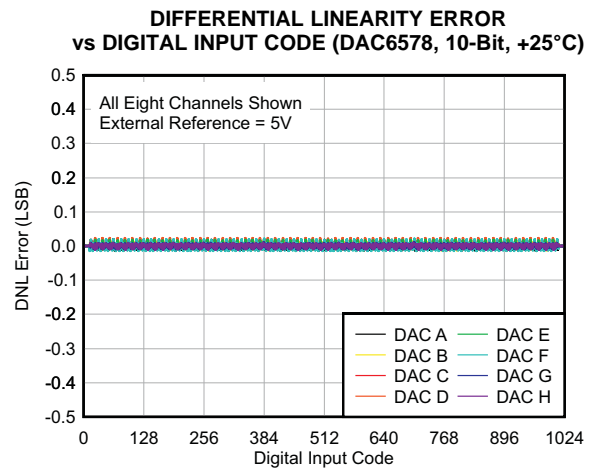

Figure 11.

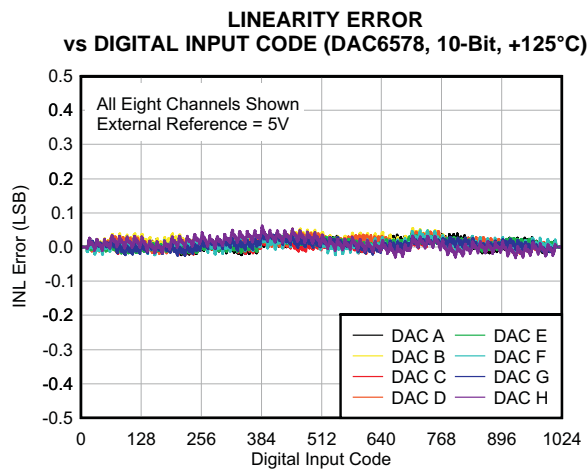

Figure 12.

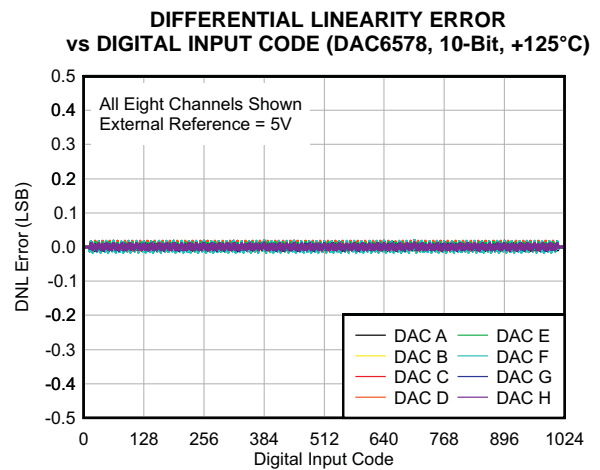

Figure 13.

TYPICAL CHARACTERISTICS: DAC at AV_{DD} = 5.5 V (continued)

At T_A = 25°C, external reference used, DAC output not loaded, and all DAC codes in straight binary data format, DAC7578 graphs shown (unless otherwise noted).

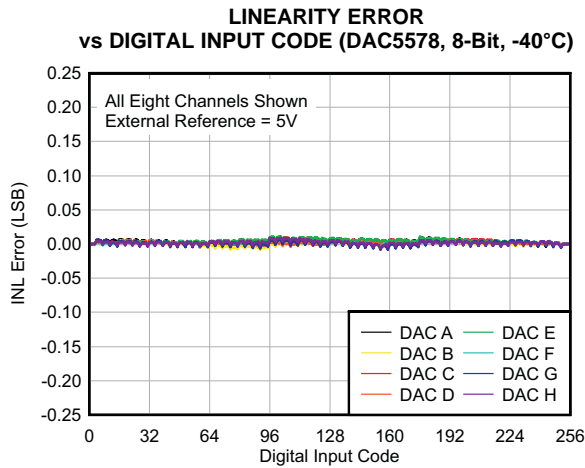

Figure 14.

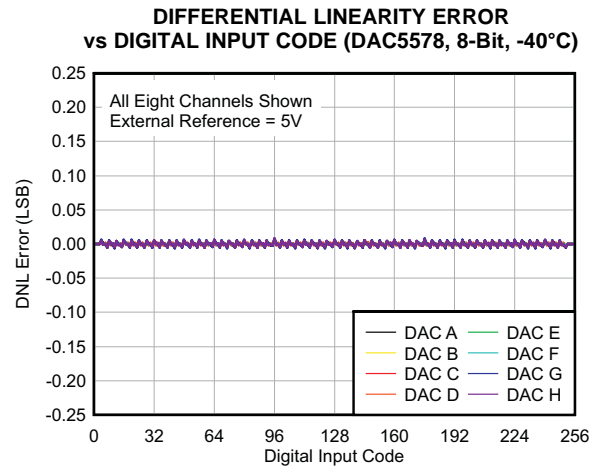

Figure 15.

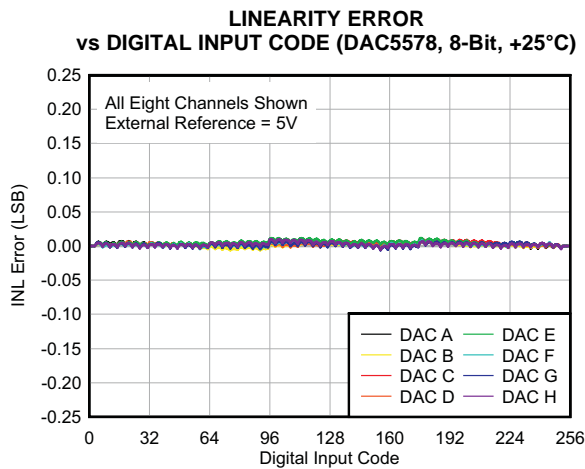

Figure 16.

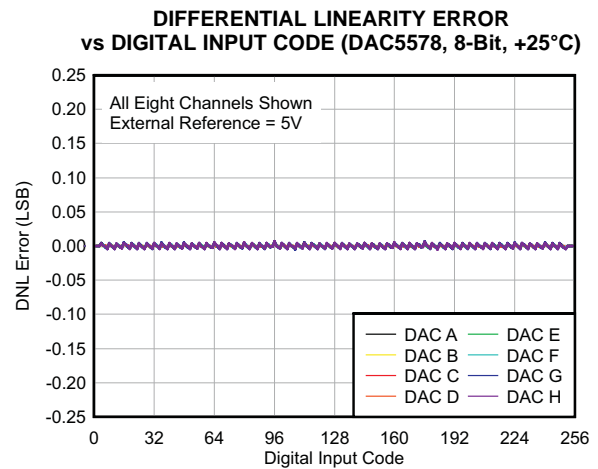

Figure 17.

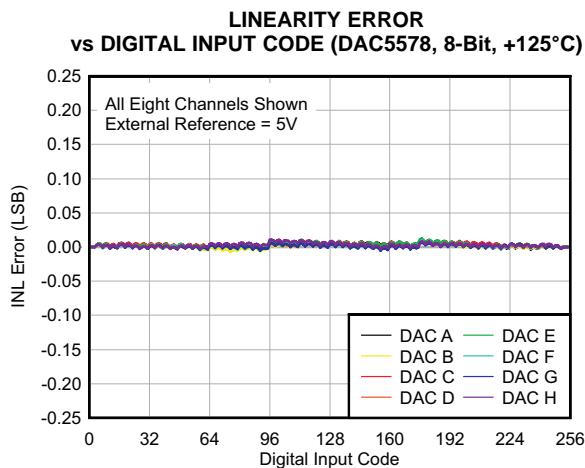

Figure 18.

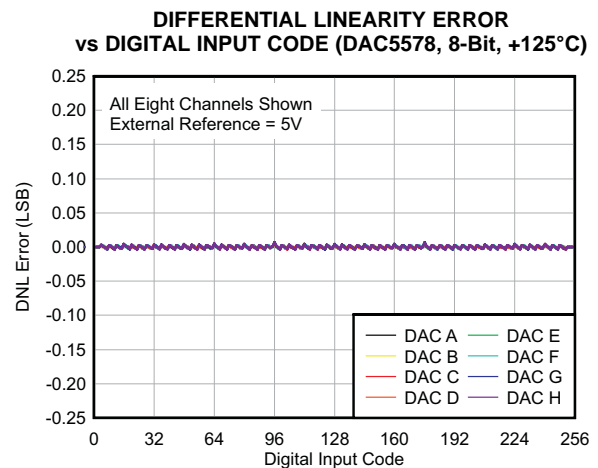

Figure 19.

TYPICAL CHARACTERISTICS: DAC at AV_{DD} = 5.5 V (continued)

At T_A = 25°C, external reference used, DAC output not loaded, and all DAC codes in straight binary data format, DAC7578 graphs shown (unless otherwise noted).

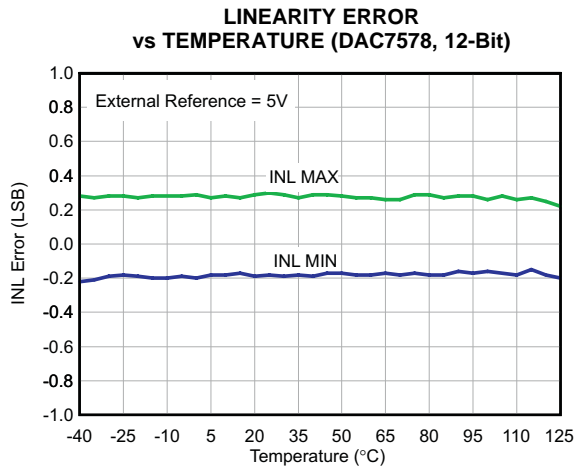

Figure 20.

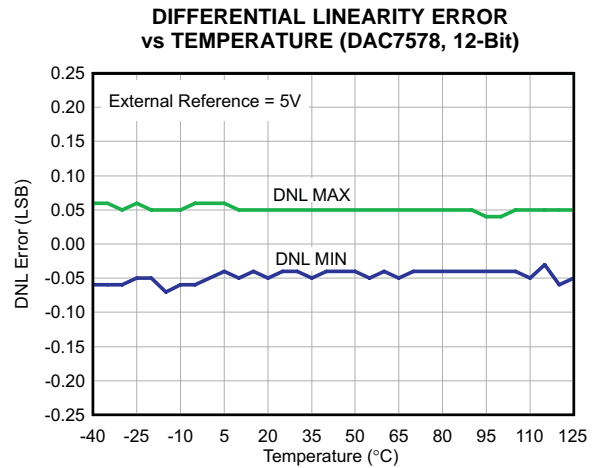

Figure 21.

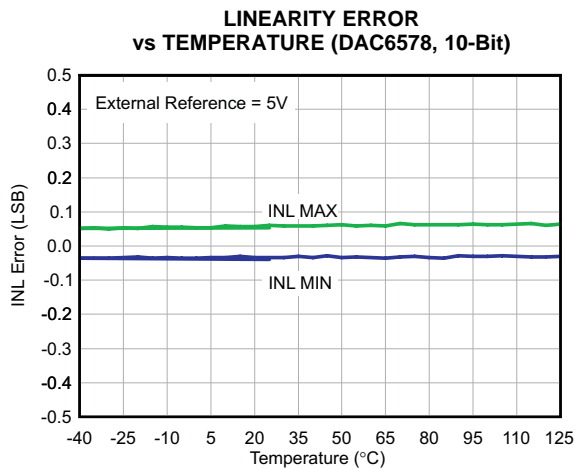

Figure 22.

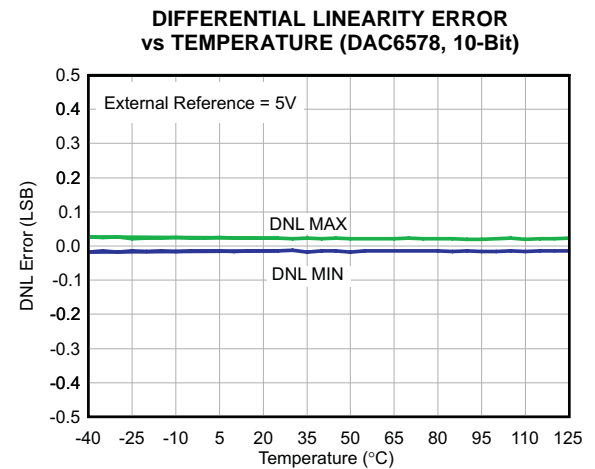

Figure 23.

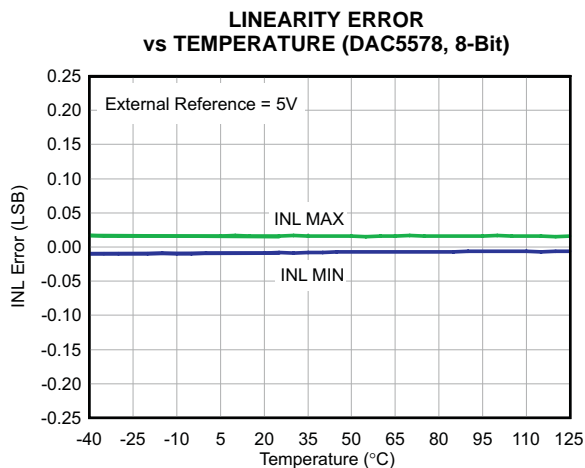

Figure 24.

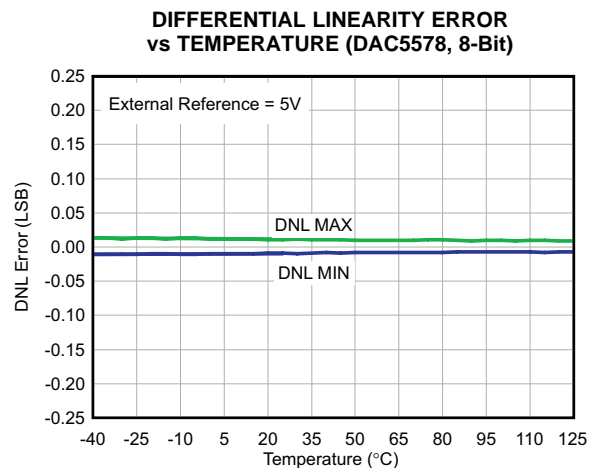

Figure 25.

TYPICAL CHARACTERISTICS: DAC at AV_{DD} = 5.5 V (continued)

At T_A = 25°C, external reference used, DAC output not loaded, and all DAC codes in straight binary data format, DAC7578 graphs shown (unless otherwise noted).

POWER SUPPLY CURRENT vs TEMPERATURE

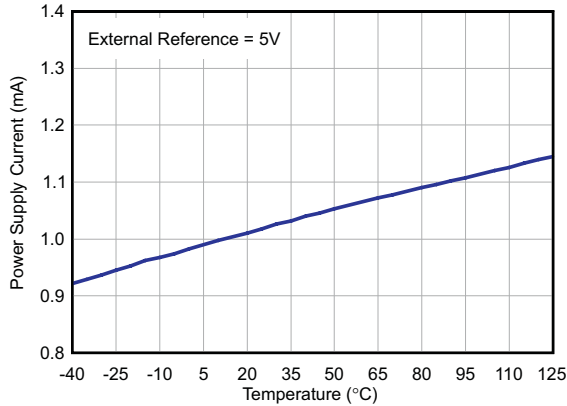

Figure 26.

OFFSET ERROR vs TEMPERATURE

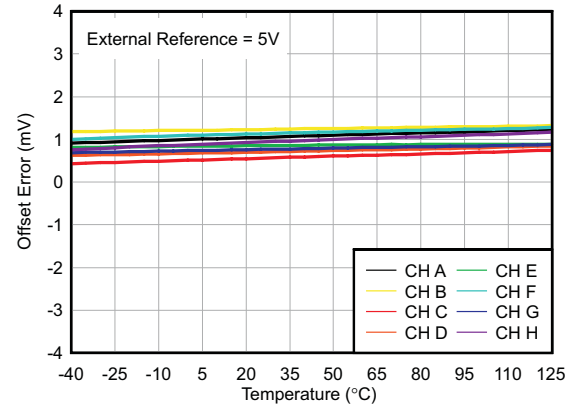

Figure 27.

POWER-DOWN CURRENT vs TEMPERATURE

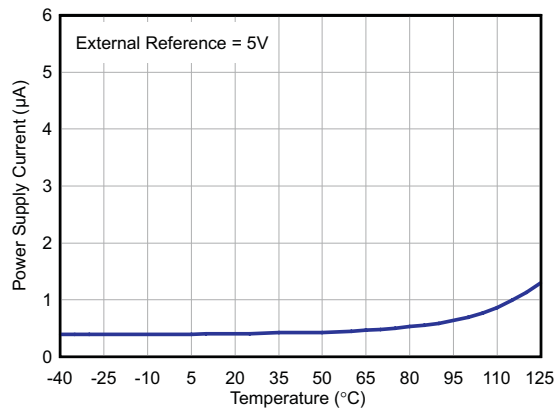

Figure 28.

FULL-SCALE ERROR vs TEMPERATURE

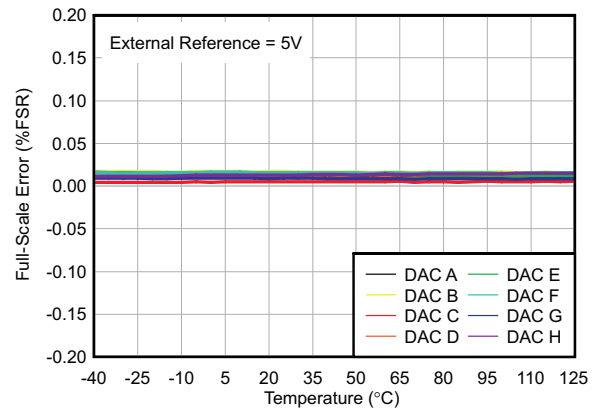

Figure 29.

GAIN ERROR vs TEMPERATURE

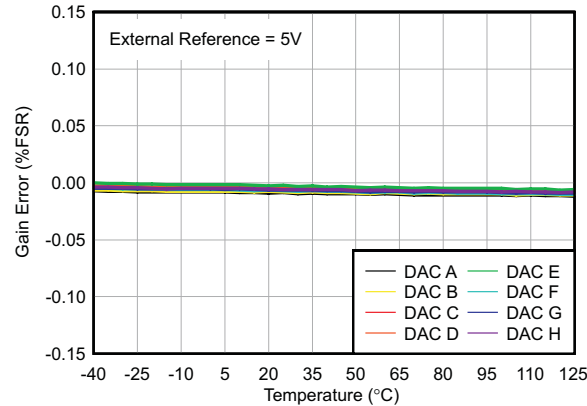

Figure 30.

TYPICAL CHARACTERISTICS: DAC at $V_{DD} = 5.5\text{ V}$ (continued)

At $T_A = 25^\circ\text{C}$, external reference used, DAC output not loaded, and all DAC codes in straight binary data format, DAC7578 graphs shown (unless otherwise noted).

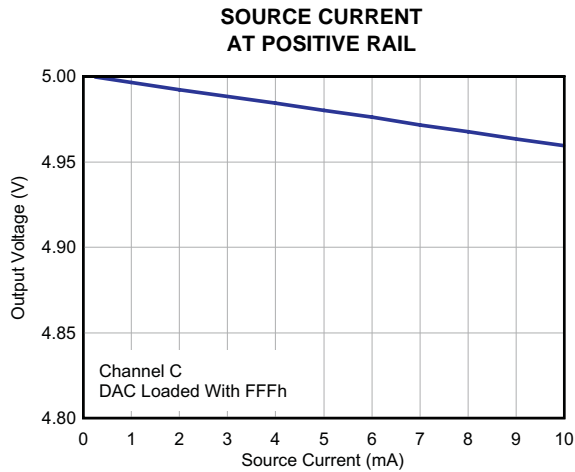

Figure 31.

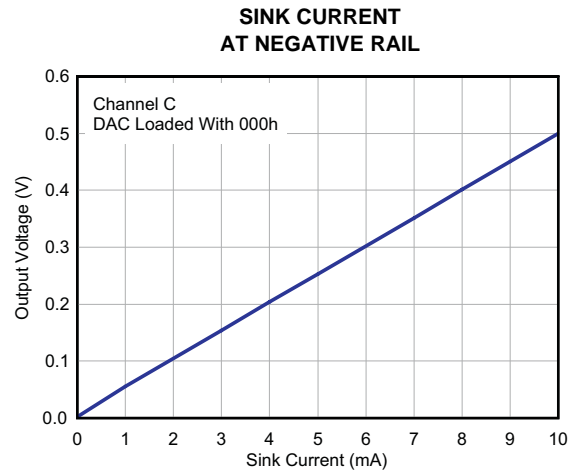

Figure 32.

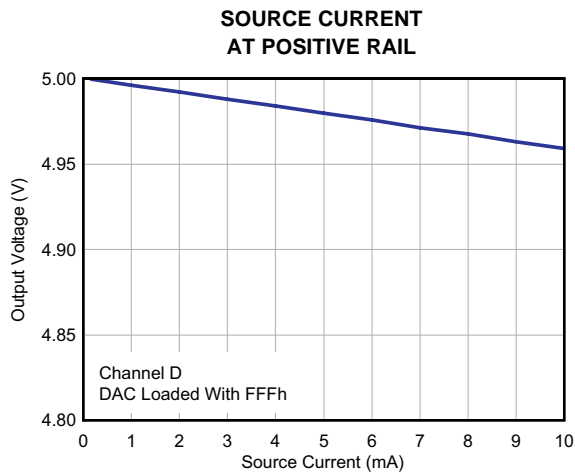

Figure 33.

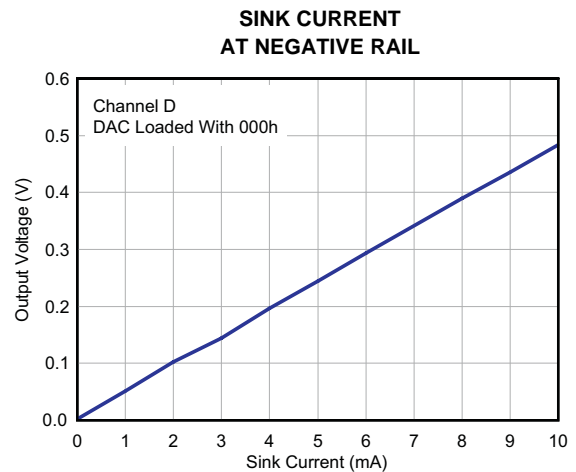

Figure 34.

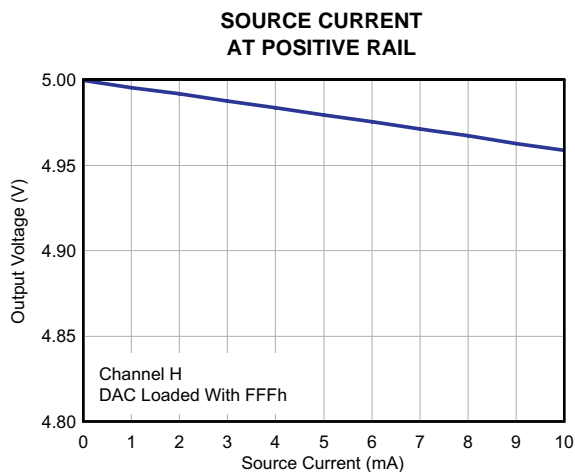

Figure 35.

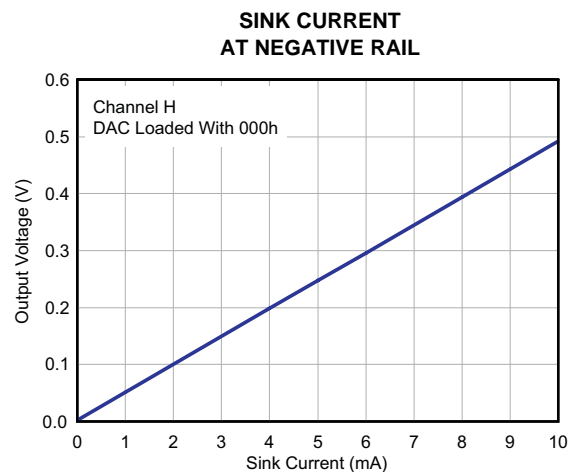

Figure 36.

TYPICAL CHARACTERISTICS: DAC at AV_{DD} = 5.5 V (continued)

At T_A = 25°C, external reference used, DAC output not loaded, and all DAC codes in straight binary data format, DAC7578 graphs shown (unless otherwise noted).

POWER SUPPLY CURRENT vs DIGITAL INPUT CODE

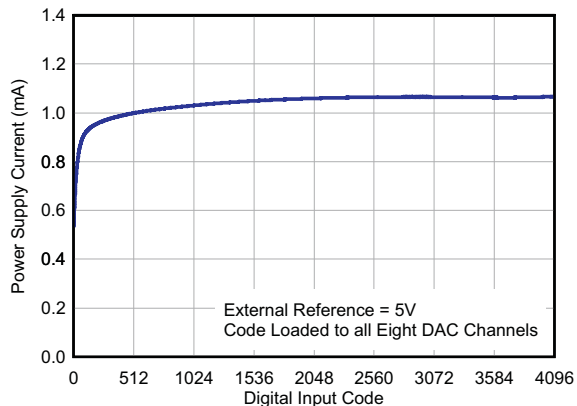

Figure 37.

POWER SUPPLY CURRENT vs POWER SUPPLY VOLTAGE

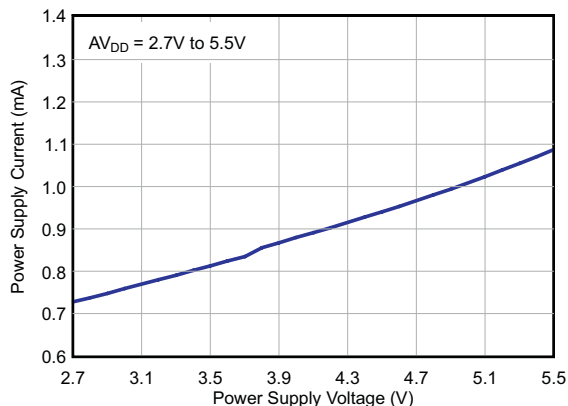

Figure 38.

POWER DOWN CURRENT vs POWER SUPPLY VOLTAGE

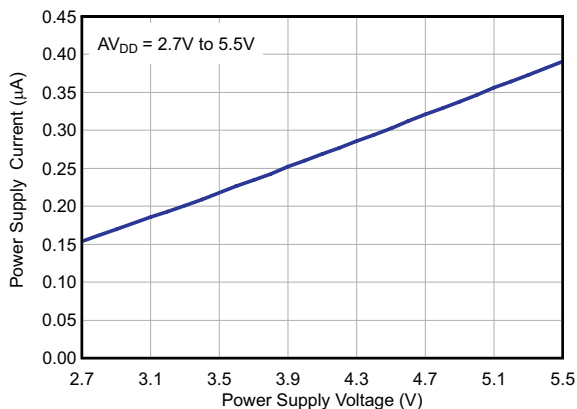

Figure 39.

POWER-SUPPLY CURRENT HISTOGRAM

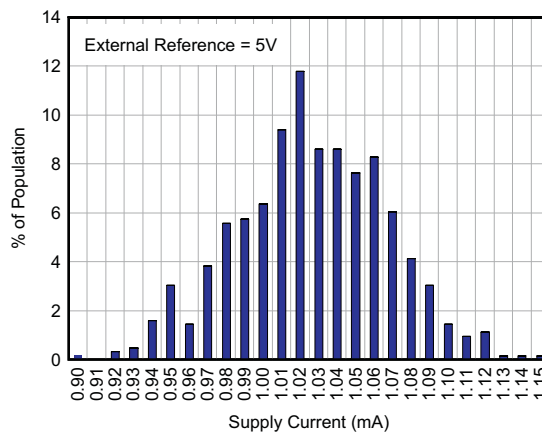

Figure 40.

FULL-SCALE SETTLING TIME: 5V RISING EDGE

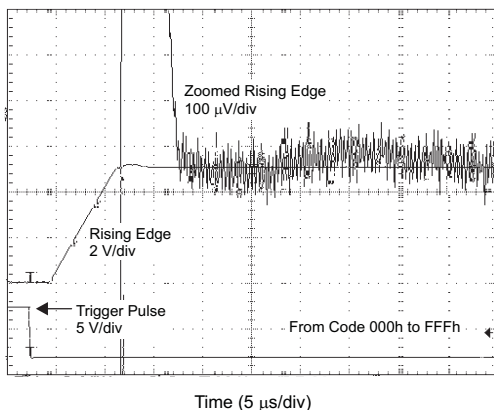

Figure 41.

FULL-SCALE SETTLING TIME: 5V FALLING EDGE

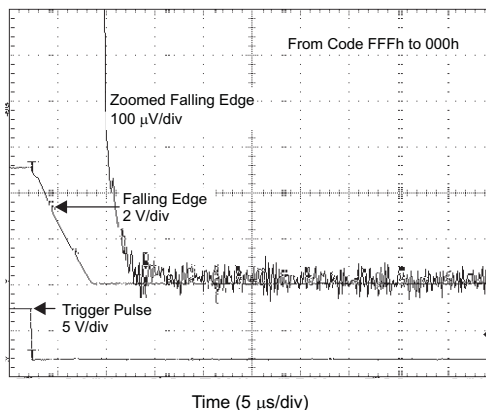

Figure 42.

TYPICAL CHARACTERISTICS: DAC at $V_{DD} = 5.5\text{ V}$ (continued)

At $T_A = 25^\circ\text{C}$, external reference used, DAC output not loaded, and all DAC codes in straight binary data format, DAC7578 graphs shown (unless otherwise noted).

**HALF-SCALE SETTLING TIME:
 5V RISING EDGE**

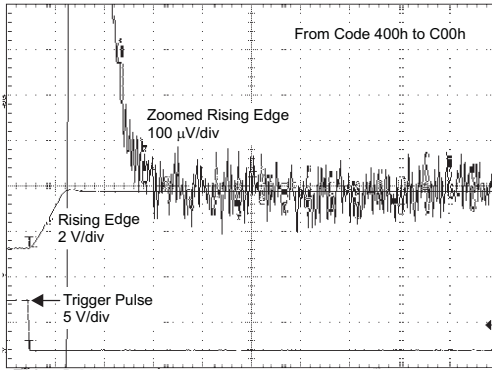

Figure 43.

**HALF-SCALE SETTLING TIME:
 5V FALLING EDGE**

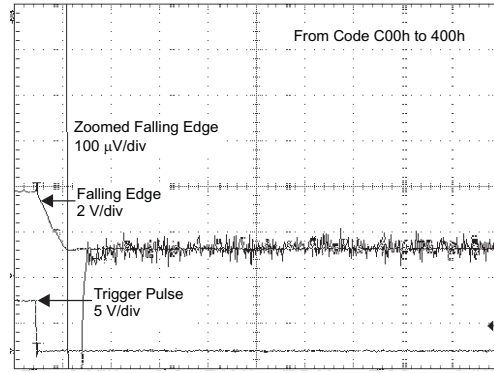

Figure 44.

**CLOCK FEEDTHROUGH
 400 kHz MIDSACLE**

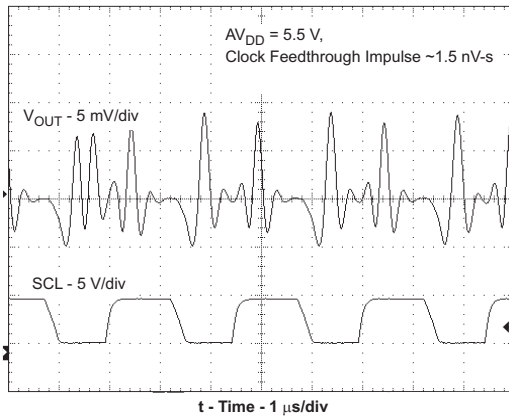

Figure 45.

**POWER-ON GLITCH
 RESET TO ZERO SCALE**

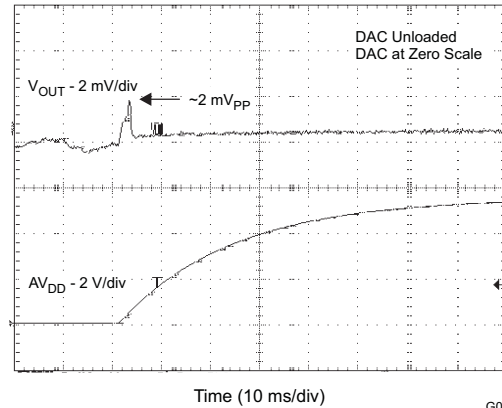

Figure 46.

**POWER-ON GLITCH
 RESET-TO-MID SCALE**

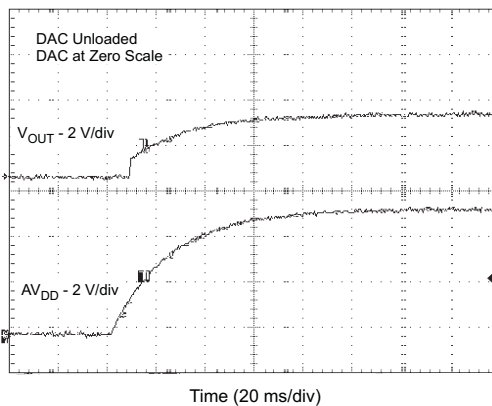

Figure 47.

POWER-OFF GLITCH

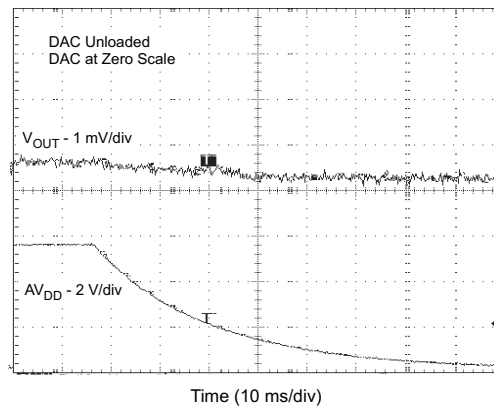
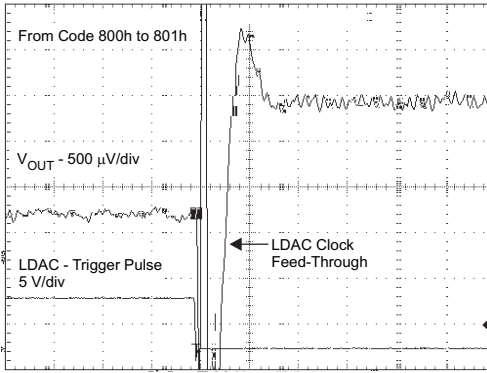

Figure 48.

TYPICAL CHARACTERISTICS: DAC at $V_{DD} = 5.5\text{ V}$ (continued)

At $T_A = 25^\circ\text{C}$, external reference used, DAC output not loaded, and all DAC codes in straight binary data format, DAC7578 graphs shown (unless otherwise noted).

**GLITCH ENERGY:
5V, 12-BIT, 1LSB STEP, RISING EDGE**



Time (2 μs/div)

Figure 49.

**GLITCH ENERGY:
5V, 12-BIT, 1LSB STEP, FALLING EDGE**

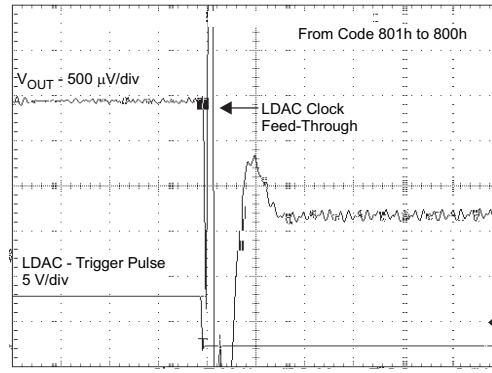

Time (2 μs/div)

Figure 50.

**GLITCH ENERGY:
5V, 10-BIT, 1LSB STEP, RISING EDGE**

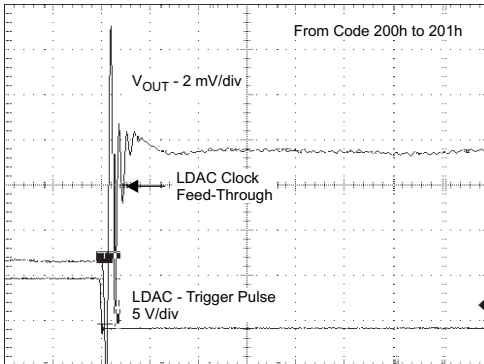

Time (2 μs/div)

Figure 51.

**GLITCH ENERGY:
5V, 10-BIT, 1LSB STEP, FALLING EDGE**

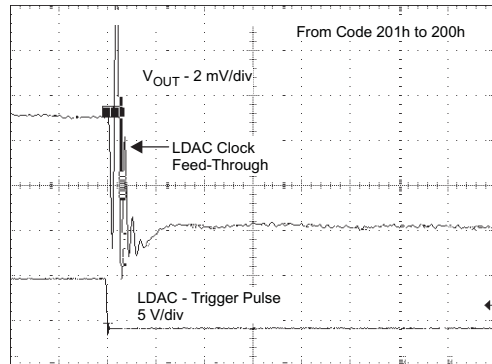

Time (2 μs/div)

Figure 52.

**GLITCH ENERGY:
5V, 8-BIT, 1LSB STEP, RISING EDGE**

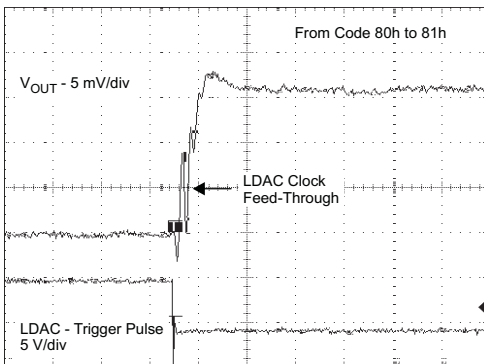

Time (2 μs/div)

Figure 53.

**GLITCH ENERGY:
5V, 8-BIT, 1LSB STEP, FALLING EDGE**

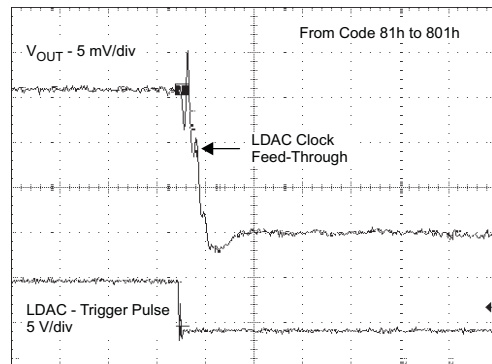

Time (2 μs/div)

Figure 54.

TYPICAL CHARACTERISTICS: DAC at $V_{DD} = 5.5\text{ V}$ (continued)

At $T_A = 25^\circ\text{C}$, external reference used, DAC output not loaded, and all DAC codes in straight binary data format, DAC7578 graphs shown (unless otherwise noted).

DAC OUTPUT NOISE DENSITY vs FREQUENCY

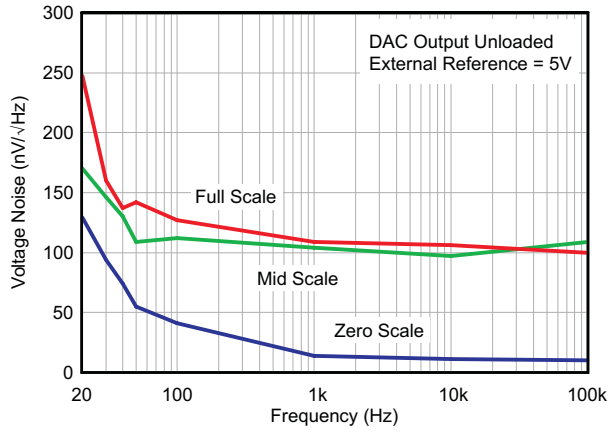

Figure 55.

**DAC OUTPUT NOISE
 0.1 Hz to 10 Hz**

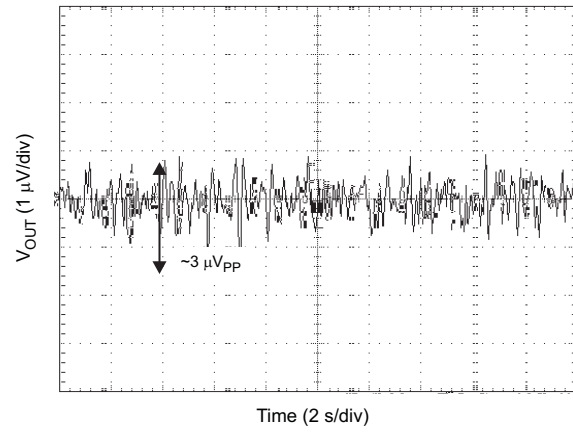

Figure 56.

TYPICAL CHARACTERISTICS: DAC AT $V_{DD} = 3.6\text{ V}$

At $T_A = 25^\circ\text{C}$, external reference used, DAC output not loaded, and all DAC codes in straight binary data format, DAC7578 graphs shown (unless otherwise noted).

POWER SUPPLY CURRENT vs TEMPERATURE

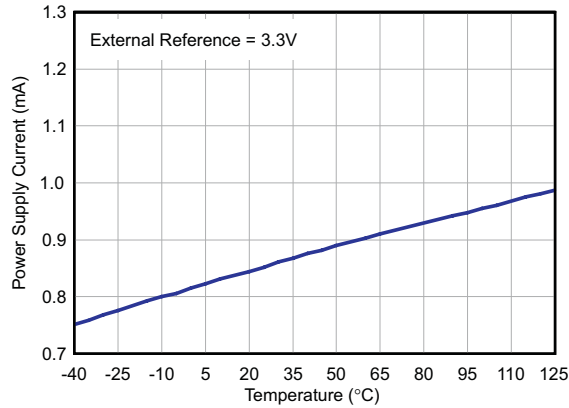

Figure 57.

POWER SUPPLY CURRENT vs DIGITAL INPUT CODE

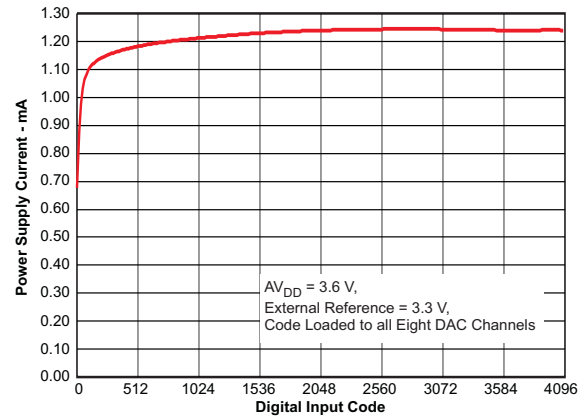

Figure 58.

POWER SUPPLY CURRENT HISTOGRAM

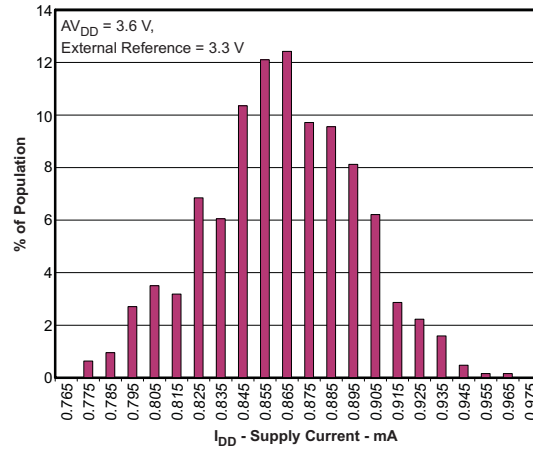

Figure 59.

TYPICAL CHARACTERISTICS: DAC AT $V_{DD} = 2.7\text{ V}$

At $T_A = 25^\circ\text{C}$, external reference used, DAC output not loaded, and all DAC codes in straight binary data format, DAC7578 graphs shown (unless otherwise noted).

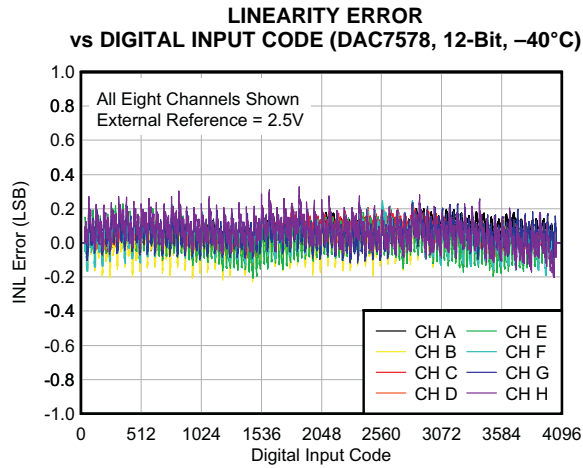

Figure 60.

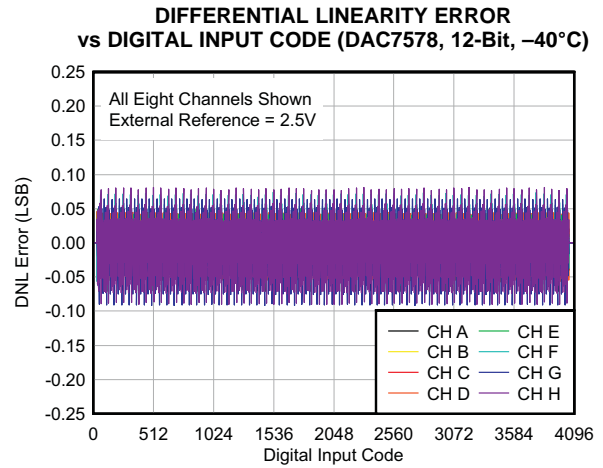

Figure 61.

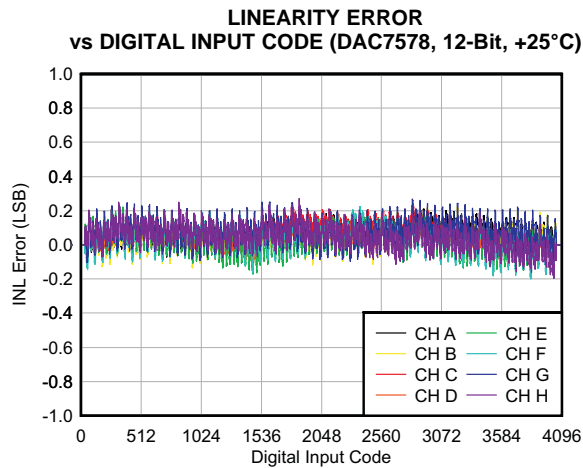

Figure 62.

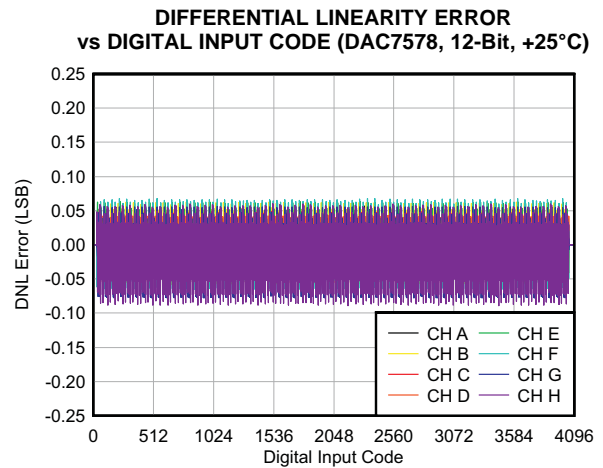

Figure 63.

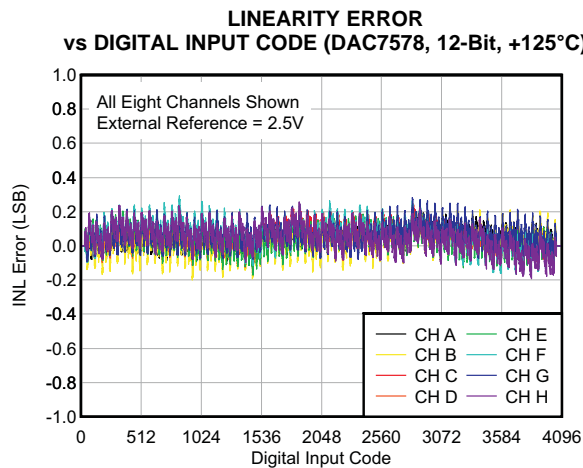

Figure 64.

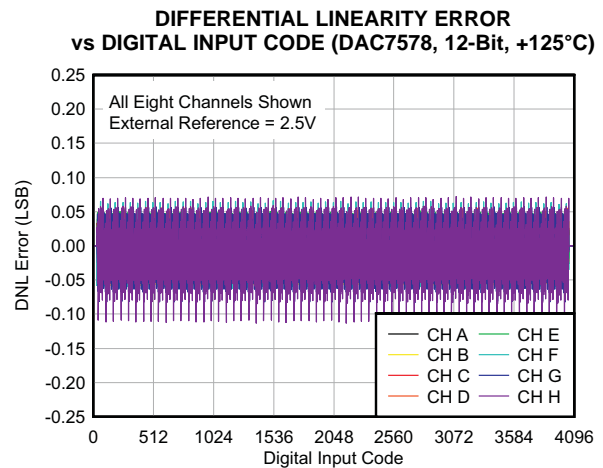

Figure 65.

TYPICAL CHARACTERISTICS: DAC AT $V_{DD} = 2.7\text{ V}$ (continued)

At $T_A = 25^\circ\text{C}$, external reference used, DAC output not loaded, and all DAC codes in straight binary data format, DAC7578 graphs shown (unless otherwise noted).

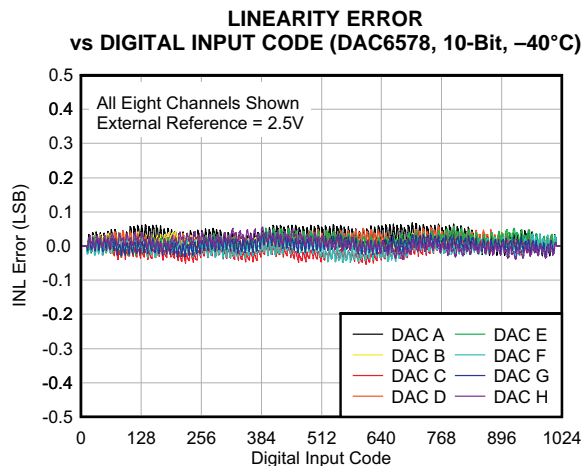

Figure 66.

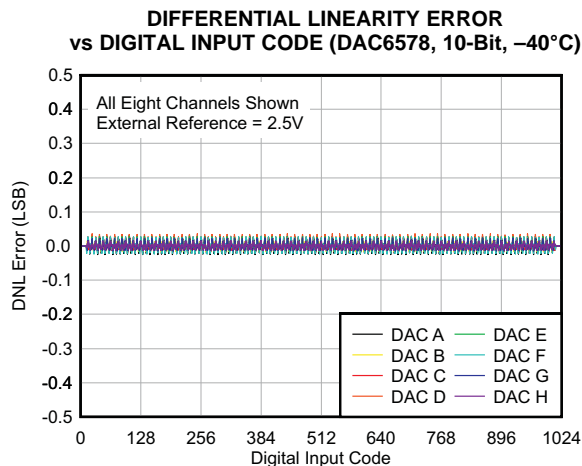

Figure 67.

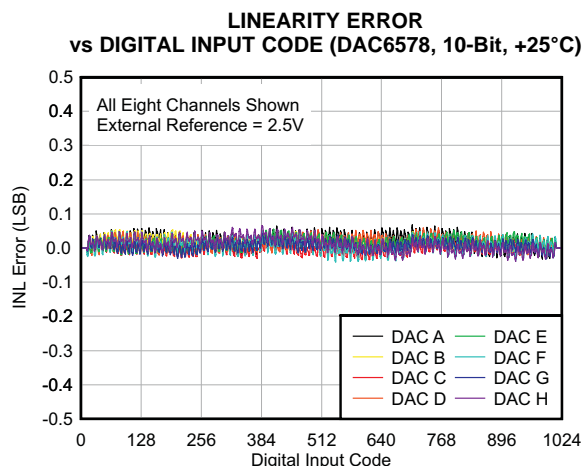

Figure 68.

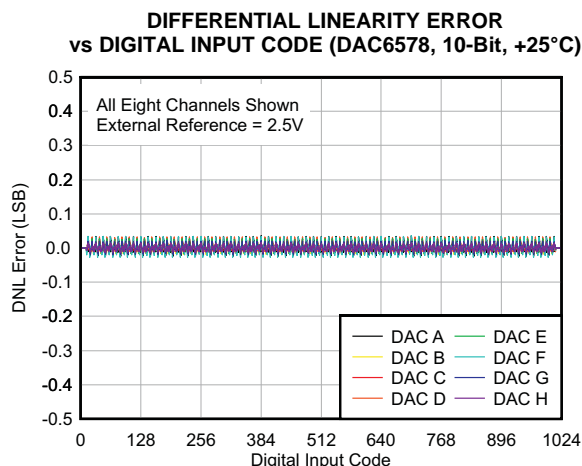

Figure 69.

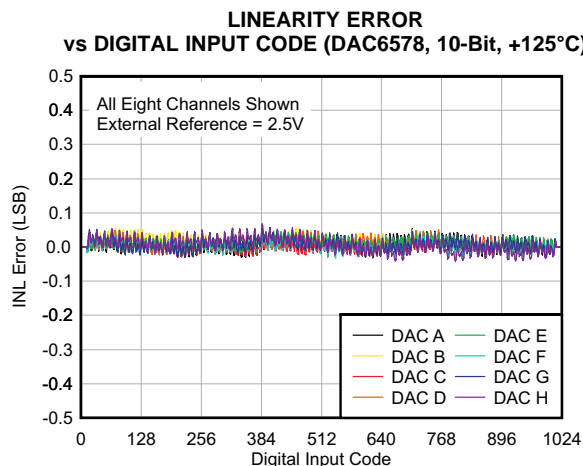

Figure 70.

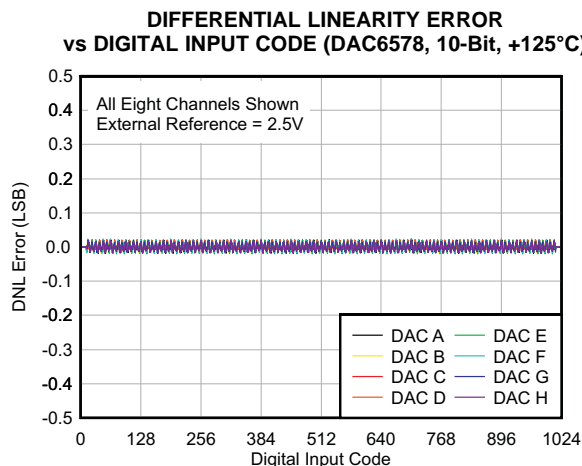

Figure 71.

TYPICAL CHARACTERISTICS: DAC AT $V_{DD} = 2.7\text{ V}$ (continued)

At $T_A = 25^\circ\text{C}$, external reference used, DAC output not loaded, and all DAC codes in straight binary data format, DAC7578 graphs shown (unless otherwise noted).

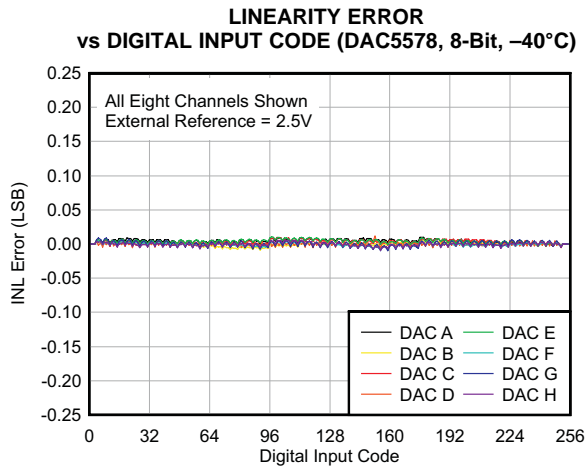

Figure 72.

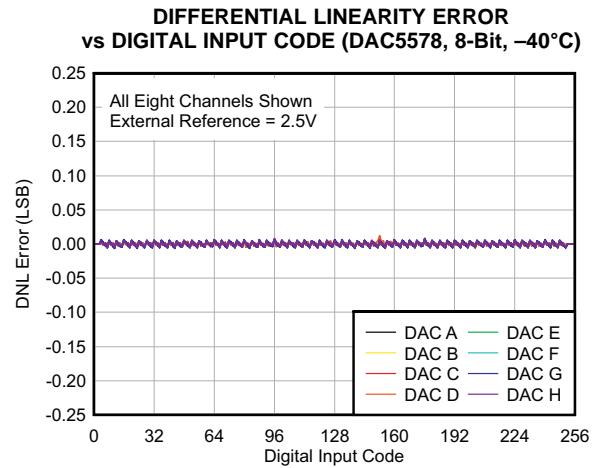

Figure 73.

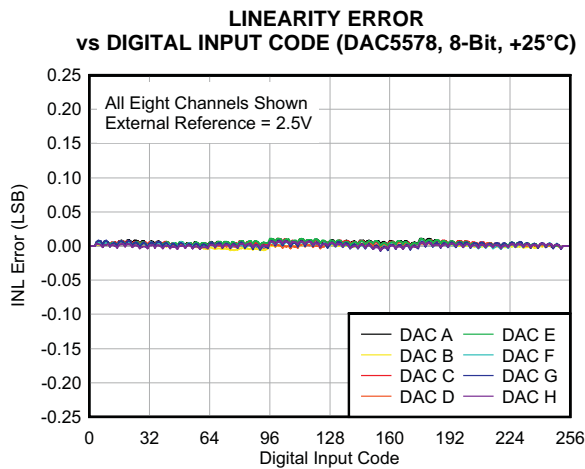

Figure 74.

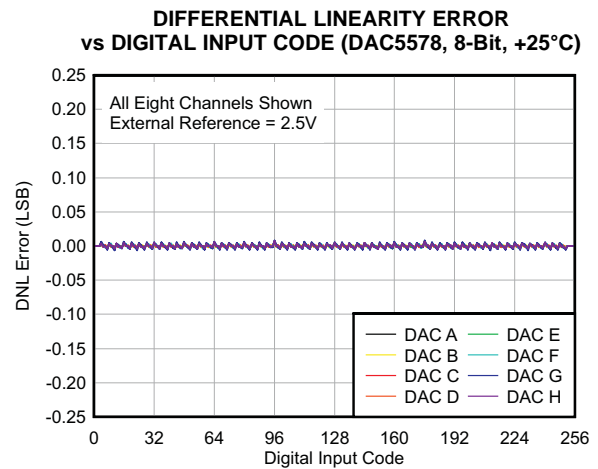

Figure 75.

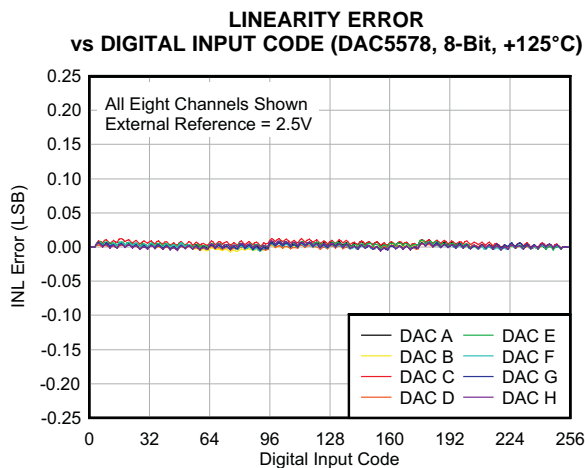

Figure 76.

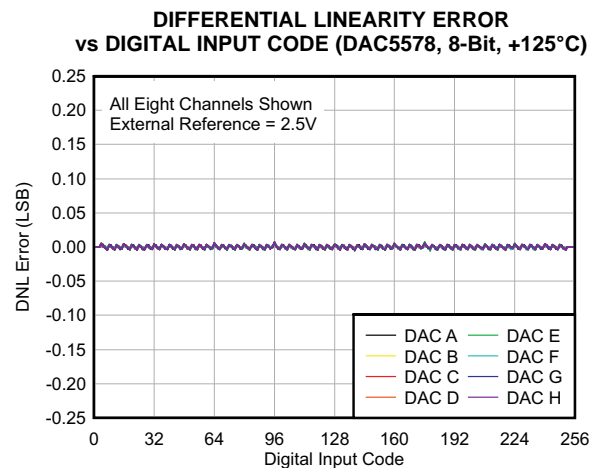

Figure 77.

TYPICAL CHARACTERISTICS: DAC AT $V_{DD} = 2.7\text{ V}$ (continued)

At $T_A = 25^\circ\text{C}$, external reference used, DAC output not loaded, and all DAC codes in straight binary data format, DAC7578 graphs shown (unless otherwise noted).

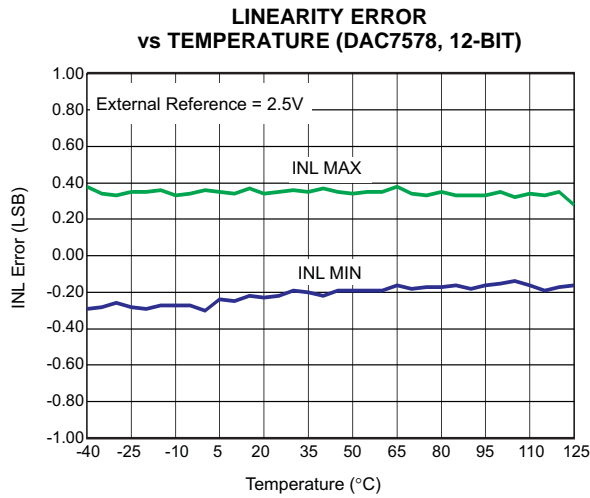

Figure 78.

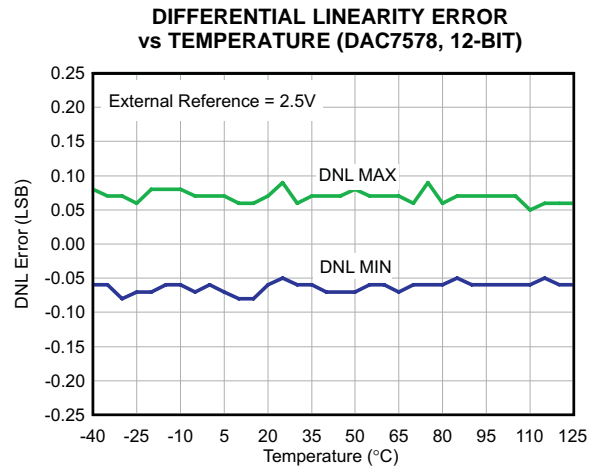

Figure 79.

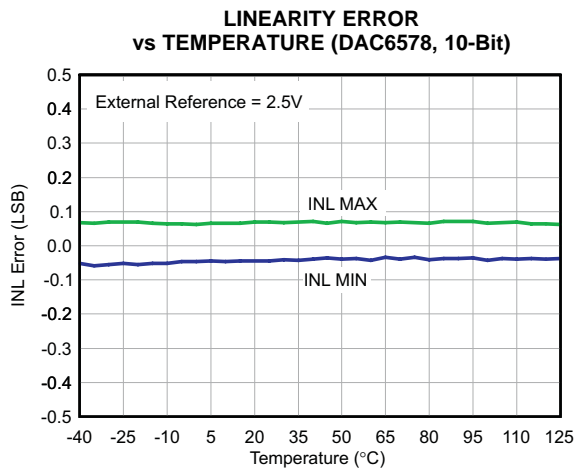

Figure 80.

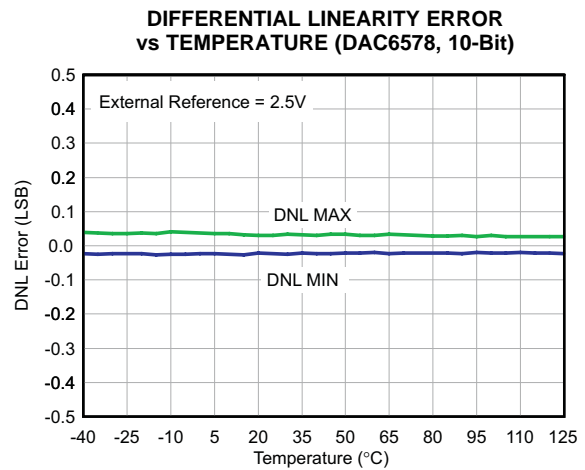

Figure 81.

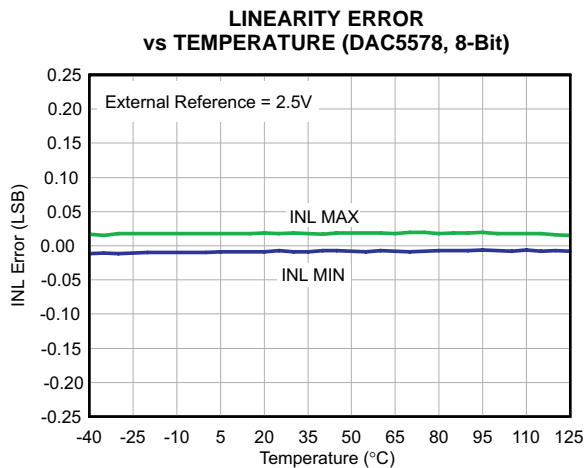

Figure 82.

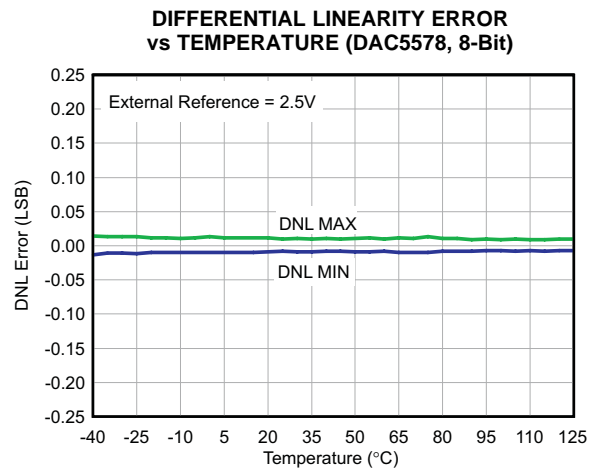

Figure 83.

TYPICAL CHARACTERISTICS: DAC AT $V_{DD} = 2.7\text{ V}$ (continued)

At $T_A = 25^\circ\text{C}$, external reference used, DAC output not loaded, and all DAC codes in straight binary data format, DAC7578 graphs shown (unless otherwise noted).

POWER-SUPPLY CURRENT vs TEMPERATURE

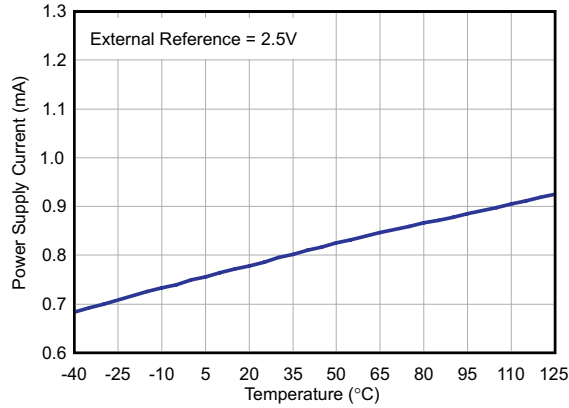

Figure 84.

OFFSET ERROR vs TEMPERATURE

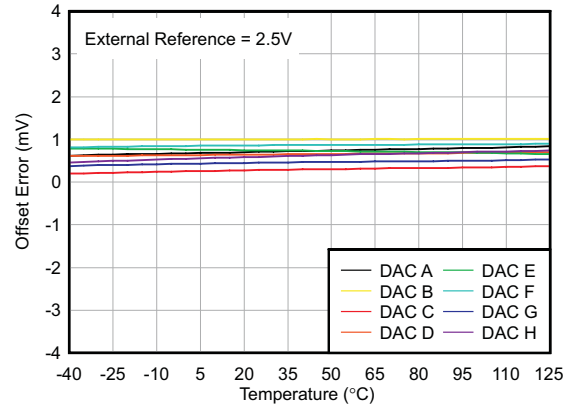

Figure 85.

POWER-DOWN CURRENT vs TEMPERATURE

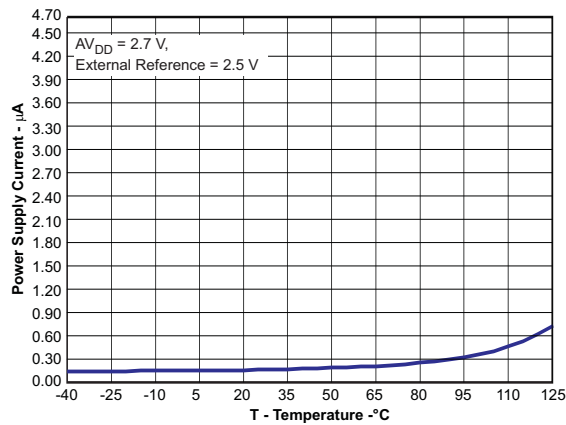

Figure 86.

FULL-SCALE ERROR vs TEMPERATURE

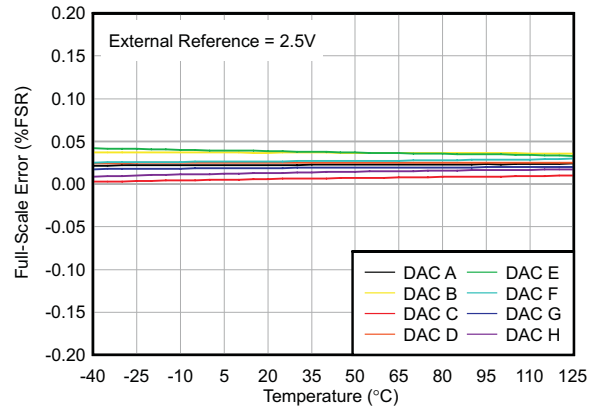

Figure 87.

GAIN ERROR vs TEMPERATURE

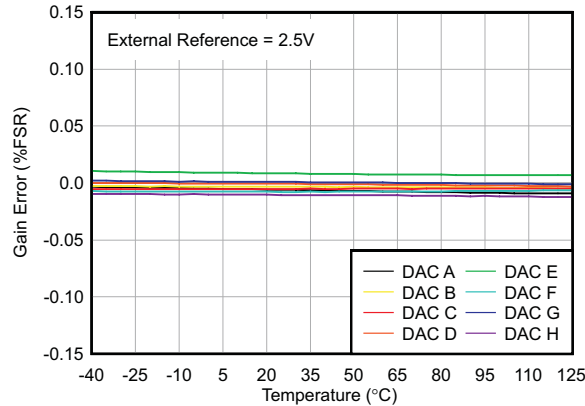

Figure 88.

TYPICAL CHARACTERISTICS: DAC AT $V_{DD} = 2.7\text{ V}$ (continued)

At $T_A = 25^\circ\text{C}$, external reference used, DAC output not loaded, and all DAC codes in straight binary data format, DAC7578 graphs shown (unless otherwise noted).

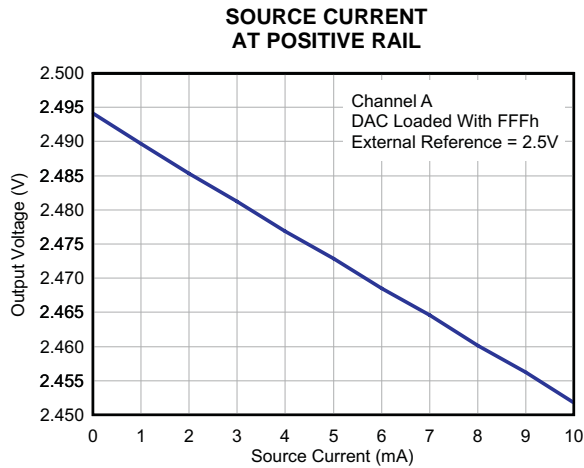

Figure 89.

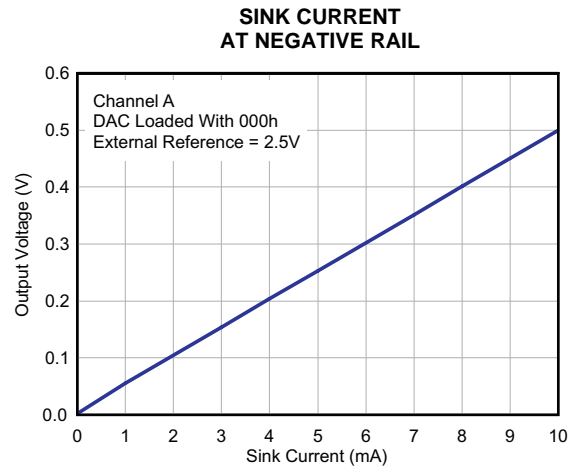

Figure 90.

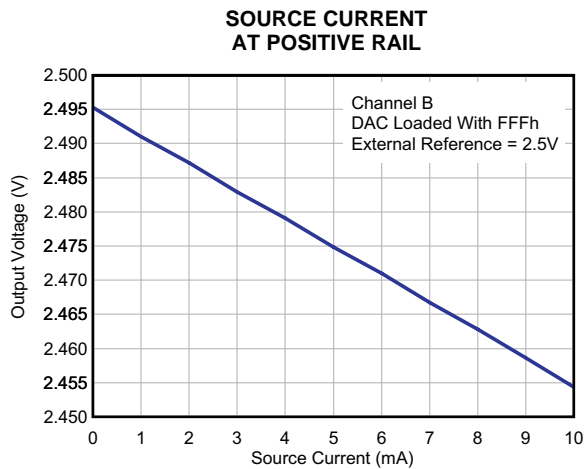

Figure 91.

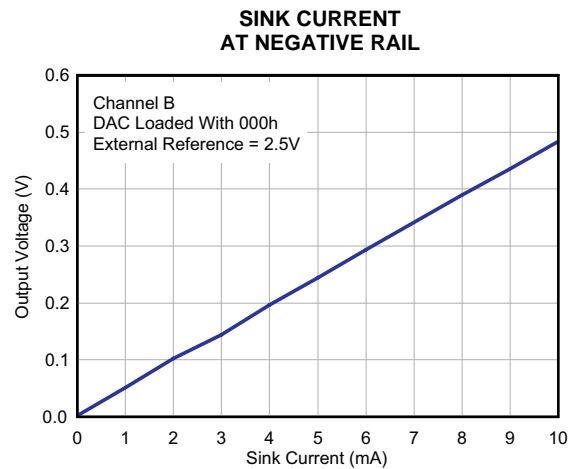

Figure 92.

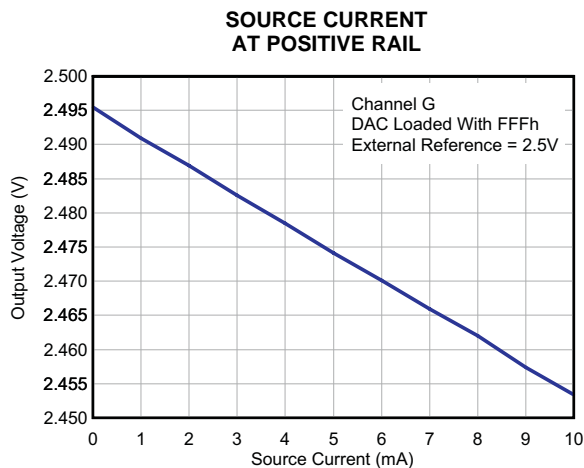

Figure 93.

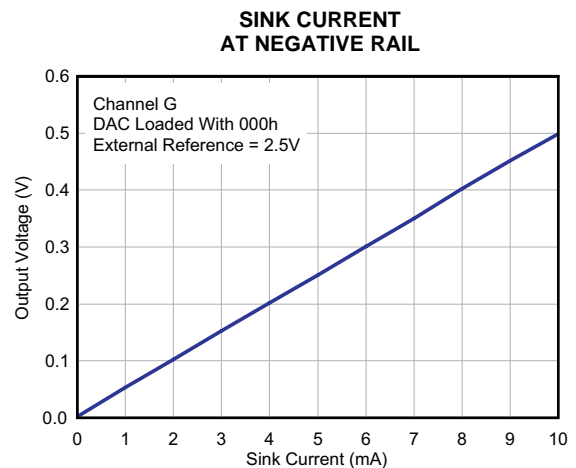

Figure 94.

TYPICAL CHARACTERISTICS: DAC AT $V_{DD} = 2.7\text{ V}$ (continued)

At $T_A = 25^\circ\text{C}$, external reference used, DAC output not loaded, and all DAC codes in straight binary data format, DAC7578 graphs shown (unless otherwise noted).

**POWER SUPPLY CURRENT
 DIGITAL INPUT CODE**

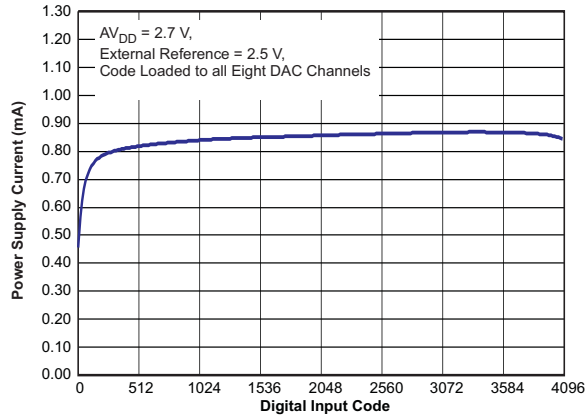

Figure 95.

**POWER SUPPLY CURRENT
 HISTOGRAM**

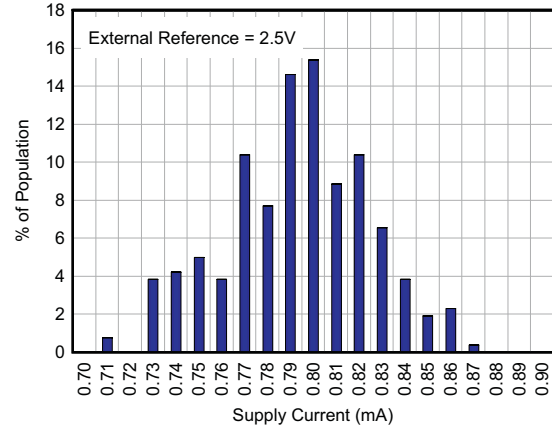

Figure 96.

**FULL-SCALE SETTLING TIME:
 2.7V RISING EDGE**

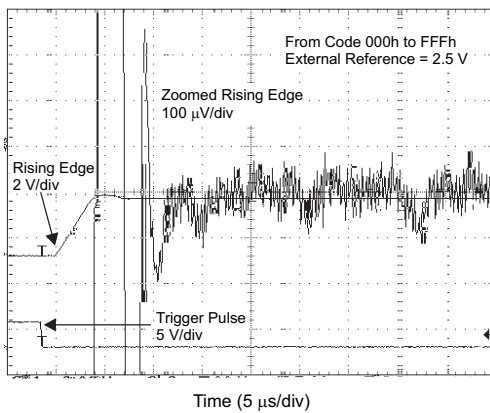

Figure 97.

**FULL-SCALE SETTLING TIME:
 2.7V FALLING EDGE**

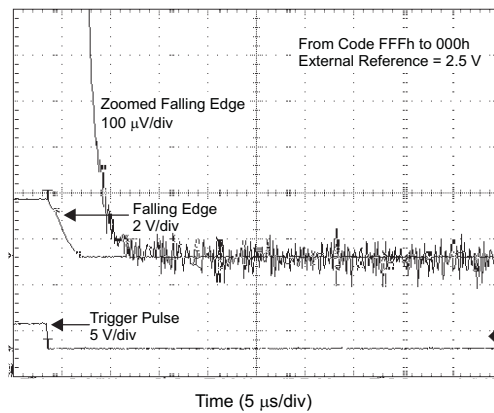

Figure 98.

**HALF-SCALE SETTLING EDGE:
 2.7V RISING EDGE**

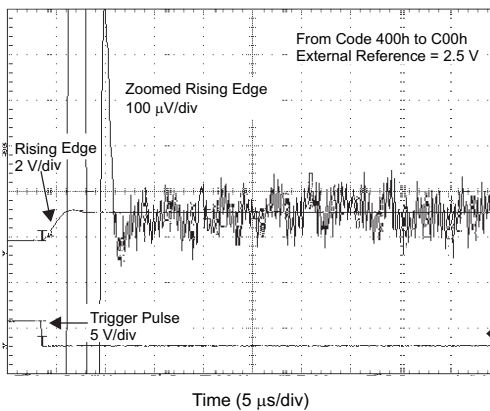

Figure 99.

**HALF-SCALE SETTLING TIME:
 2.7V FALLING EDGE**

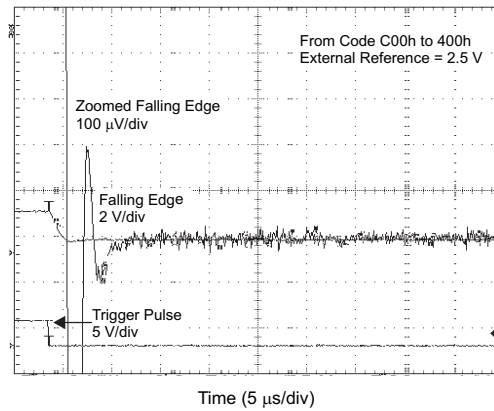
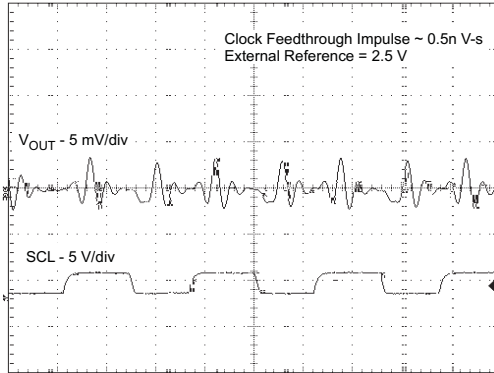

Figure 100.

TYPICAL CHARACTERISTICS: DAC AT $V_{DD} = 2.7\text{ V}$ (continued)

At $T_A = 25^\circ\text{C}$, external reference used, DAC output not loaded, and all DAC codes in straight binary data format, DAC7578 graphs shown (unless otherwise noted).

**CLOCK FEEDTHROUGH
400 kHz, MIDSACLE**



Time (1 $\mu\text{s}/\text{div}$)

Figure 101.

**POWER-ON GLITCH
RESET TO ZERO SCALE**

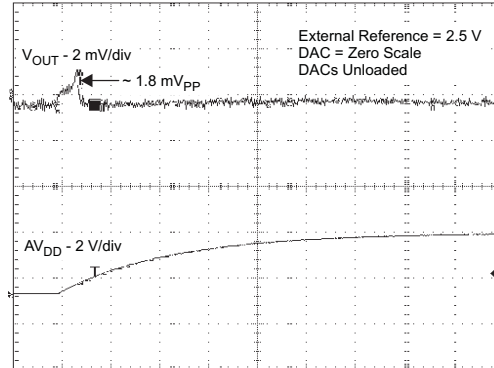

Time (10 ms/div)

Figure 102.

**POWER-ON GLITCH
RESET TO MIDSACLE**

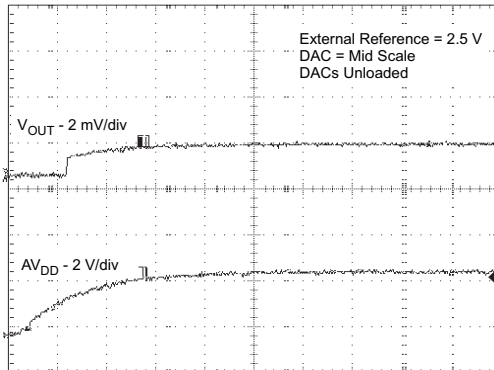

Time (20 ms/div)

Figure 103.

POWER-OFF GLITCH

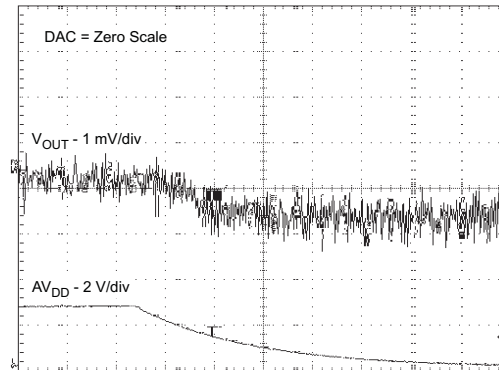

Time (10 ms/div)

Figure 104.

**GLITCH ENERGY:
2.7V, 12-BIT, 1LSB STEP, RISING EDGE**

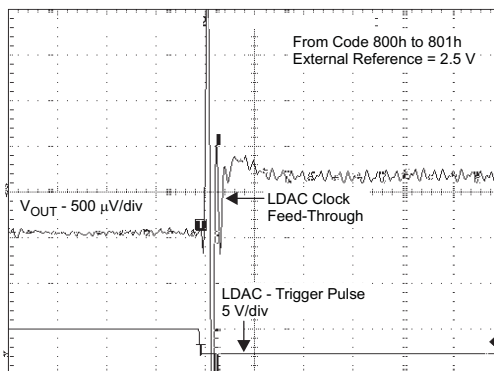

Time (2 $\mu\text{s}/\text{div}$)

Figure 105.

**GLITCH ENERGY:
2.7V, 12-BIT, 1LSB STEP, FALLING EDGE**

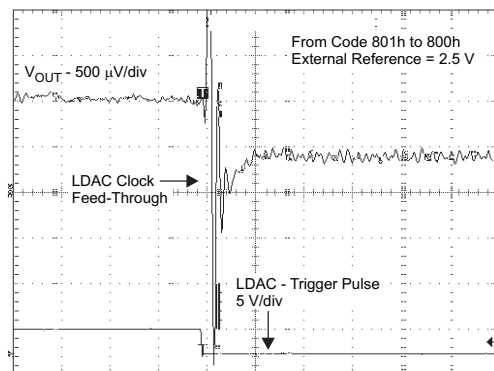

Time (2 $\mu\text{s}/\text{div}$)

Figure 106.

TYPICAL CHARACTERISTICS: DAC AT $V_{DD} = 2.7\text{ V}$ (continued)

At $T_A = 25^\circ\text{C}$, external reference used, DAC output not loaded, and all DAC codes in straight binary data format, DAC7578 graphs shown (unless otherwise noted).

**GLITCH ENERGY:
 2.7V, 10-BIT, 1LSB STEP, FALLING EDGE**

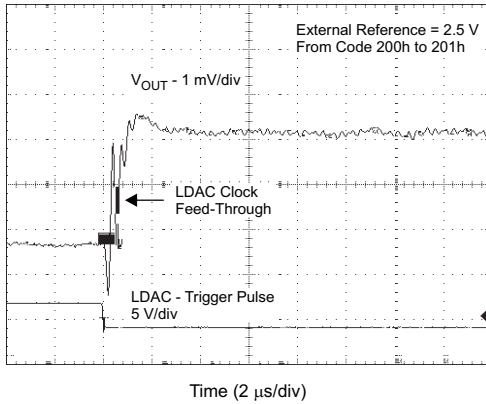

Figure 107.

**GLITCH ENERGY:
 2.7V, 10-BIT, 1LSB STEP, FALLING EDGE**

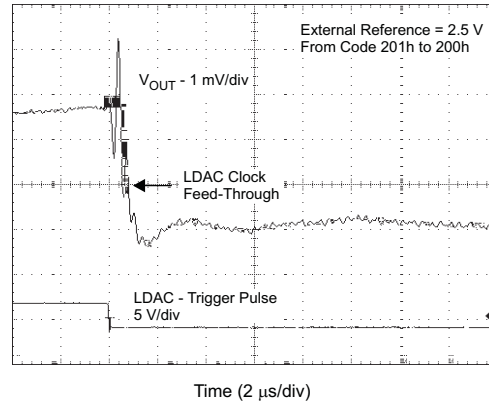

Figure 108.

**GLITCH ENERGY:
 2.7V, 8-BIT, 1LSB STEP, RISING EDGE**

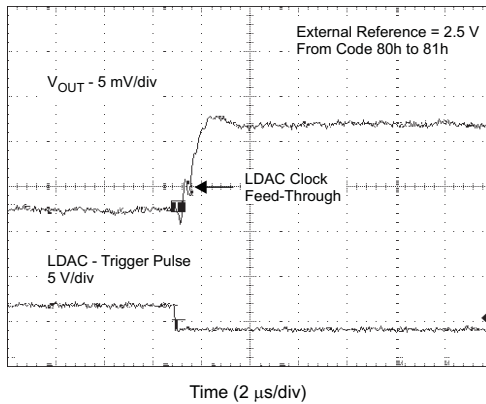

Figure 109.

**GLITCH ENERGY:
 2.7V, 8-BIT, 1LSB STEP, FALLING EDGE**

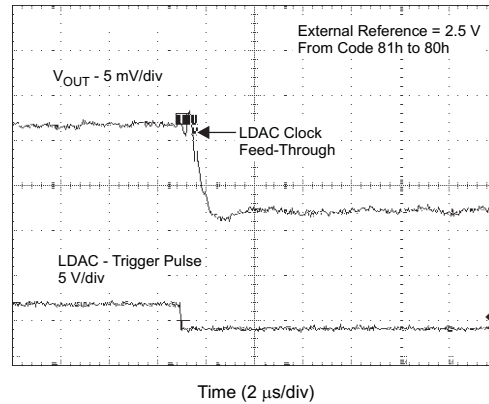

Figure 110.

THEORY OF OPERATION

DIGITAL-TO-ANALOG CONVERTER (DAC)

The DAC5578, DAC6578, and DAC7578 (DACx578) architecture consists of eight string DACs each followed by an output buffer amplifier. Figure 111 shows a principal block diagram of the DAC architecture.

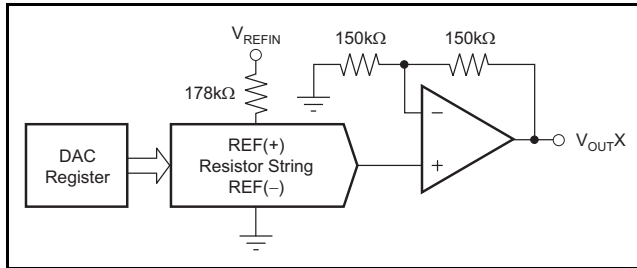

Figure 111. Device Architecture

For the TSSOP package, the input coding is straight binary. For the QFN package, the TWOC pin controls the code format.

When using an external reference, the ideal output voltage is given by Equation 1:

$$V_{OUT} = \frac{D_{IN}}{2^n} \times V_{REFIN} \quad (1)$$

Where:

D_{IN} = decimal equivalent of the binary code that is loaded to the DAC register. The code can range from 0 to 255 for the 8-bit DAC5578, 0 to 1023 (DAC6578) and 0 to 4095 (DAC7578).

V_{REFIN} = external reference voltage of 0V to 5V, supplied at the V_{REFIN} pin.

n = resolution on bits; 8 (DAC5578), 10 (DAC6578), or 12 (DAC7578)

RESISTOR STRING

The resistor string circuitry is shown in Figure 112. It is a string of resistors, each of value R . The code loaded into the DAC register determines at which node on the string the voltage is tapped off to be fed into the output amplifier by closing one of the switches connecting the string to the amplifier. It is monotonic because it is a string of resistors. The overall gain is one and allows the user to provide an external reference value of 0 to AV_{DD} .

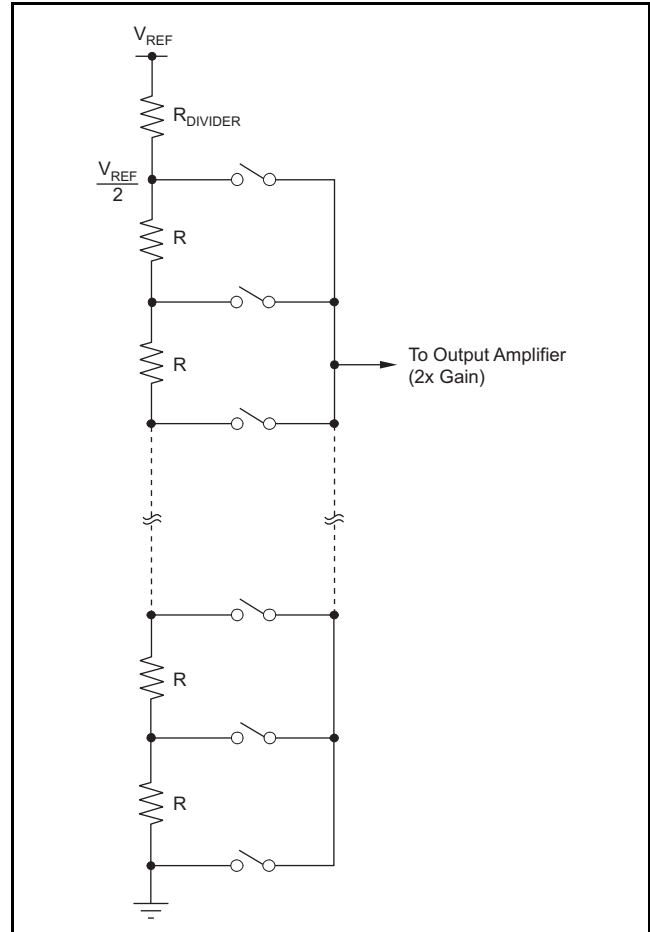

Figure 112. Resistor String

OUTPUT AMPLIFIER

The output buffer amplifier is capable of generating rail-to-rail voltages on its output, giving a maximum output range of 0V to AV_{DD} . It is capable of driving a load of $2k\Omega$ in parallel with $1000pF$ to GND. The source and sink capabilities of the output amplifier can be seen in the Typical Characteristics. The typical slew rate is $0.75V/\mu s$, with a typical full-scale settling time of $7\mu s$ with the output unloaded.

TWO-WIRE, I²C-COMPATIBLE INTERFACE

The two-wire serial interface used by the DACx578 is I²C-compatible (refer to the I²C Bus Specification). The bus consists of a data line (SDA) and a clock line (SCL) with pull-up resistors. When the bus is idle, both SDA and SCL lines are pulled high. All I²C-compatible devices connect to the I²C bus through open-drain I/O pins SDA and SCL.

The I²C specification states that the device that controls communication is called a master, and the devices that are controlled by the master are called slaves. The master device generates the SCL signal. The master device also generates special timing conditions (start, repeated start, and stop) on the bus to indicate the start or stop of a data transfer, as shown in Figure 113. Device addressing is also performed by the master. The master device on an I²C bus is usually a microcontroller or a digital signal processor (DSP). The DACx578 operates as a slave device on the I²C bus. A slave device acknowledges the master commands, and upon the direction of the master, either receives or transmits data.

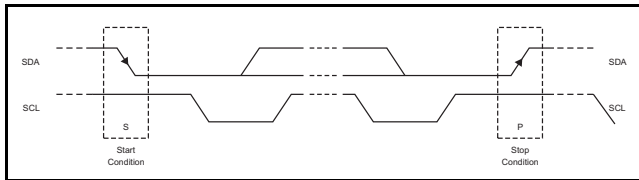

Figure 113.

Although the DACx578 normally operates as a slave receiver, when a master device acquires the DACx578 internal register data, the DACx578 also operates as a slave transmitter. In this case, the master device reads from the DACx578 (the slave transmitter). According to I²C terminology, read and write operations are always performed with respect to the master device.

The DACx578 supports the following data transfer modes, as defined in the I²C Bus Specification:

- Standard mode (100kbps)
- Fast mode (400kbps)
- Fast mode plus (1.0Mbps)⁽¹⁾
- High-Speed mode (3.4Mbps)

The data transfer protocols for Standard and Fast modes are exactly the same; therefore, these modes are referred to as *F/S mode* in this document. The protocol for High-Speed mode is different from the F/S mode, and it is referred to as *HS mode*. The DACx578 supports 7-bit addressing. Note that 10-bit addressing and a general call address are not supported.

(1) The DACx578 supports Fast mode plus speed and timing specifications only. These devices cannot support the 20mA low-level output current specification.

Other than specific timing signals, the I²C interface works with serial bytes. At the end of each byte, a ninth clock cycle is used to generate/detect an acknowledge signal, as shown in Figure 114. An *acknowledge* is when the SDA line is pulled low during the high period of the ninth clock cycle. A *not-acknowledge* is when the SDA line is left high during the high period of the ninth clock cycle.

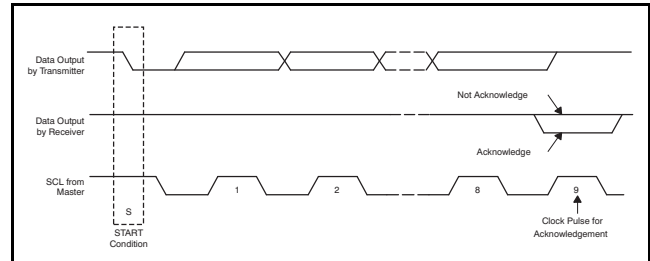

Figure 114. Acknowledge and Not Acknowledge Signals on the I²C Bus

F/S Mode Protocol

- The master initiates data transfer by generating a start condition, defined as when a high-to-low transition occurs on the SDA line while SCL is high, as shown in Figure 114. All I²C-compatible devices recognize a start condition.
- The master then generates the SCL pulses, and transmits the 7-bit address and the read/write direction bit (R/\bar{W}) on the SDA line. During all transmissions, the master ensures that data are valid. A valid data condition requires the SDA line to be stable during the entire high period of the clock pulse, as shown in Figure 115. All devices recognize the address sent by the master and compare it to the internal fixed addresses. Only the slave device with a matching address generates an acknowledge by pulling the SDA line low during the entire high period of the ninth SCL cycle, as shown in Figure 114. Upon detecting this acknowledge, the master recognizes the communication link with a slave has been established.
- The master generates additional SCL cycles to either transmit data to the slave (R/\bar{W} bit = '0') or receive data from the slave (R/\bar{W} bit = '1'). In either case, the receiver must acknowledge the data sent by the transmitter. So the acknowledge signal can either be generated by the master or by the slave, depending on which one is the receiver. The 9-bit valid data sequences, consisting of eight data bits and one acknowledge bit, can continue as long as necessary.
- To signal the end of the data transfer, the master generates a stop condition by pulling the SDA line from low to high while the SCL line is high (see Figure 115). This action releases the bus and stops the communication link with the addressed

slave. All I²C-compatible devices recognize the stop condition. Upon receipt of a stop condition, the bus is released, and all slave devices then wait for a start condition followed by a matching address.

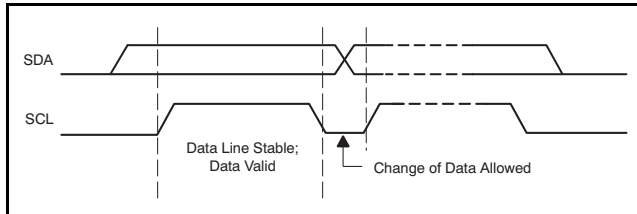

Figure 115. I²C Bus Bit Transfer

HS Mode Protocol

- When the bus is idle, both the SDA and SCL lines are pulled high by the pull-up resistors.
- The master generates a start condition followed by a valid serial byte containing HS mode master code *00001XXX*. This transmission is made in F/S mode at no more than 1.0Mbps. No device is allowed to acknowledge the HS mode master code, but all devices must recognize it and switch the respective internal settings to support 3.4Mbps operation.
- The master then generates a repeated start condition (a repeated start condition has the same timing as the start condition). After this repeated start condition, the protocol is the same as F/S mode, except that transmission speeds up to 3.4Mbps are allowed. A stop condition ends HS mode and switches all the internal settings of the slave devices to support F/S mode. Instead of using a stop condition, repeated start conditions should be used to secure the bus in HS mode.

DACx578 I²C UPDATE SEQUENCE

For a single update, the DACx578 requires a start condition, a valid I²C address (A) byte, a command and access (CA) byte, and two data bytes, the most significant data byte (MSDB) and least significant data byte (LSDB), as shown in Table 1.

After each byte is received, the DACx578 acknowledges by pulling the SDA line low during the high period of a single clock pulse, as shown in Figure 116. These four bytes and acknowledge cycles make up the 36 clock cycles required for a single update to occur. A valid I²C address selects the corresponding slave device (for example, DACx578).

The CA byte sets the operational mode of the selected DACx578. When the operational mode is selected by this byte, the DACx578 must receive two data bytes, the most significant data byte (MSDB) and least significant data byte (LSDB), for data update to occur. The DACx578 performs an update on the falling edge of the acknowledge signal that follows the LSDB.

The CA byte does not have to be re-sent until a change in operational mode is required. The bits of the control byte continuously determine the type of update performed. Thus, for the first update, the DACx578 requires a start condition, a valid I²C address, the CA byte, and two data bytes (MSDB and LSDB). For all consecutive updates, the DACx578 needs only an MSDB and LSDB, as long as the CA byte command remains the same.

When using the I²C HS mode (clock = 3.4MHz), each 12-bit DAC update other than the first update can be done within 18 clock cycles (MSDB, acknowledge signal, LSDB, acknowledge signal) at 188.88kSPS. When using Fast mode (clock = 400kHz), the maximum DAC update rate is limited to 22.22kSPS. Using the Fast mode plus (clock = 1MHz), the maximum DAC update rate is limited to 55.55kSPS. When a stop condition is received, the DACx578 releases the I²C bus and awaits a new start condition.

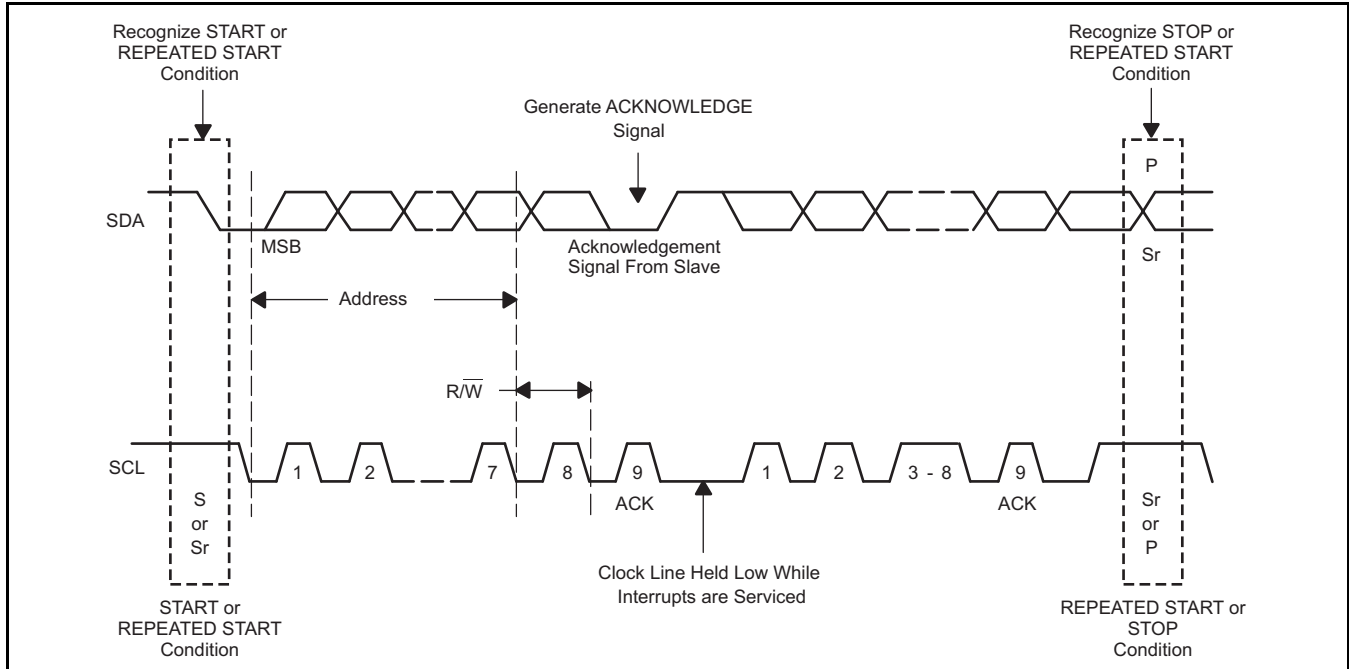

Figure 116. I²C Bus Protocol

Table 1. Update Sequence

MSB	...	LSB	ACK	MSB	...	LSB	ACK	MSB	...	LSB	ACK	MSB	...	LSB	ACK
Address (A) Byte				Command/Access Byte				MSDB				LSDB			
DB[32:24]				DB[23:16]				DB[15:8]				DB[7:0]			

Address (A) Byte

The address byte, shown in Table 2, is the first byte received following the start condition from the master device. The first four most significant bits (MSBs) of the address are factory preset to '1001'. The next three bits of the address are controlled by the ADDR pin(s). The ADDR pin(s) inputs can be connected to

AV_{DD}, GND, or left floating. The device address can be updated dynamically between serial commands. When using the QFN package (DAC5578RGE, DAC6578RGE, and DAC7578RGE), up to eight devices can be connected to the same I²C bus. When using the TSSOP package (DAC5578PW, DAC6578PW, and DAC7578PW), up to three devices can be connected to the same I²C bus.

Table 2. Address Byte

MSB							LSB
AD6	AD5	AD4	AD3	AD2	AD1	AD0	R/W
1	0	0	1	See Table 3 or Table 4 Slave Address column			0 or 1

Table 3. Address Format For QFN-24 (RGE) Package

SLAVE ADDRESS	ADDR1	ADDR0
1001 000	0	0
1001 001	0	1
1001 010	1	0
1001 011	1	1
1001 100	Float	0
1001 101	Float	1
1001 110	0	Float
1001 111	1	Float
Not supported	Float	Float

Table 4. Address Format For TSSOP-16 (PW) Package

SLAVE ADDRESS	ADDR0
1001 000	0
1001 010	1
1001 100	Float

Command and Access (CA) Byte

The command and access byte, as shown in [Table 5](#), controls which command is executed and which

register is being accessed when writing to or reading from the DACx578. See [Table 6](#) for a list of write and read commands.

Table 5. Command and Access Byte

MSB				LSB			
C3	C2	C1	C0	A3	A2	A1	A0
Command bits ⁽¹⁾				Access bits ⁽¹⁾			

(1) See [Table 6](#) for bit selection.

Table 6. Command and Access Byte Format⁽¹⁾

C3	C2	C1	C0	A3	A2	A1	A0	DESCRIPTION
Write Sequences								
0	0	0	0	A3	A2	A1	A0	Write to DAC input register channel n
0	0	0	1	A3	A2	A1	A0	Select to update DAC register channel n
0	0	1	0	A3	A2	A1	A0	Write to DAC input register channel n, and update all DAC registers (global software LDAC)
0	0	1	1	A3	A2	A1	A0	Write to DAC input register channel n, and update DAC register channel n
0	1	0	0	X	X	X	X	Power down/on DAC
0	1	0	1	X	X	X	X	Write to clear code register
0	1	1	0	X	X	X	X	Write to LDAC register
0	1	1	1	X	X	X	X	Software reset
Read Sequences								
0	0	0	0	A3	A2	A1	A0	Read from DAC input register channel n
0	0	0	1	A3	A2	A1	A0	Read from DAC register channel n
0	1	0	0	X	X	X	X	Read from DAC power down register
0	1	0	1	X	X	X	X	Read from clear code register
0	1	1	0	X	X	X	X	Read from LDAC register
Access Sequences								
C3	C2	C1	C0	0	0	0	0	DAC channel A
C3	C2	C1	C0	0	0	0	1	DAC channel B
C3	C2	C1	C0	0	0	1	0	DAC channel C
C3	C2	C1	C0	0	0	1	1	DAC channel D
C3	C2	C1	C0	0	1	0	0	DAC channel E
C3	C2	C1	C0	0	1	0	1	DAC channel F
C3	C2	C1	C0	0	1	1	0	DAC channel G
C3	C2	C1	C0	0	1	1	1	DAC channel H
C3	C2	C1	C0	1	1	1	1	All DAC channels, broadcast update

(1) Any sequences other than the ones listed are invalid; improper use can cause incorrect device operation.

Most Significant Data Byte (MSDB) and Least Significant Data Byte (LSDB)

The MSDB and LSDB contain the data that are passed to the register(s) specified by the CA byte, as shown in [Table 7](#) and [Table 8](#). See [Table 14](#) for a complete list of write sequences and [Table 15](#) for a complete list of read sequences. The DACx578 updates at the falling edge of the acknowledge signal that follows the LSDB[0] bit.

Broadcast Addressing

Broadcast addressing, as shown in [Table 9](#), is also supported by the DACx578. Broadcast addressing can be used for synchronously updating or powering down multiple DACx578 devices. These devices are designed to work with each other, and with the [DAC7678](#), to support multichannel synchronous updates. Using the broadcast address command, the DACx578 responds regardless of the state of the address pins. Note that broadcast addressing is supported only in write mode (master writes to the DACx578).

I²C Read Sequence

To read any register, use the following command sequence:

1. Send a start or repeated start command with a slave address and the R/W bit set to '0' for writing. The device acknowledges this event.
2. Then send a command byte for the register to be read. The device acknowledges this event again.
3. Then send a repeated start with the slave address and the R/W bit set to '1' for reading. The device also acknowledges this event.
4. Then the device writes the MSDB of the register. The master should acknowledge this byte.
5. Finally, the device writes out the LSDB.

An alternative reading method allows for reading back of the last register written to. The sequence is a start/repeated start with slave address and the R/W bit set to '1', and the two bytes of the last register are read out, as shown in [Table 13](#).

Note that it is not possible to use the broadcast address for reading.

Table 7. Most Significant Data Byte (MSDB)

MSB						LSB	
DB15	DB14	DB13	DB12	DB11	DB10	DB9	DB8

Table 8. Least Significant Data Byte (LSDB)

MSB						LSB	
DB7	DB6	DB5	DB4	DB3	DB2	DB1	DB0

Table 9. Broadcast Address Command

MSB						LSB	
1	0	0	0	1	1	1	0

Table 10. DAC5578 Data Input Register Format

DB23				DB15								DB8				DB0							
C3	C2	C1	C0	A3	A2	A1	A0	D7	D6	D5	D4	D3	D2	D1	D0	X	X	X	X	X	X	X	X
----- Command and Address Bits -----								----- Data Bits -----								----- Don't Care -----							

Table 11. DAC6578 Data Input Register Format

DB23				DB15								DB6				DB0									
C3	C2	C1	C0	A3	A2	A1	A0	D9	D8	D7	D6	D5	D4	D3	D2	D1	D0	X	X	X	X	X	X	X	X
----- Command and Address Bits -----								----- Data Bits -----								----- Don't Care -----									

Table 12. DAC7578 Data Input Register Format

DB23				DB15								DB4				DB0							
C3	C2	C1	C0	A3	A2	A1	A0	D11	D10	D9	D8	D7	D6	D5	D4	D3	D2	D1	D0	X	X	X	X
----- Command and Address Bits -----								----- Data Bits -----								----- Don't Care -----							

Table 13. Read Sequence

S	MSB	...	R/W(0)	ACK	MSB	...	LSB	ACK	Sr	MSB	...	R/W(1)	ACK	MSB	...	LSB	ACK	MSB	...	LSB	ACK				
Address Byte					Command/Access Byte					Sr	Address Byte					MSDB					LSDB				
From master				Slave	From master				Slave	From master				slave	From Slave				Master	From Slave				Master	

Table 14. Control Matrix for Write Commands (see Table 10, Table 11, and Table 12 for 8-bit, 10-bit, and 12-bit mapping)

COMMAND AND ACCESS BYTE								MOST SIGNIFICANT DATA BYTE								LEAST SIGNIFICANT DATA BYTE								DESCRIPTION
C3	C2	C1	C0	A3	A2	A1	A0	DATA[7:0]								X	X	X	X	X	X	X	X	General data format for 8-bit DAC5578
C3	C2	C1	C0	A3	A2	A1	A0	DATA[9:2]								D1	D0	X	X	X	X	X	X	General data format for 10-bit DAC6578
C3	C2	C1	C0	A3	A2	A1	A0	DATA[11:4]								D3	D2	D1	D0	X	X	X	X	General data format for 12-bit DAC7578
Write to DAC Input Register																								
0	0	0	0	0	0	0	0	Data[11:4]								Data[3:0]				X	X	X	X	Write to DAC input register of channel A
0	0	0	0	0	0	0	1	Data[11:4]								Data[3:0]				X	X	X	X	Write to DAC input register of channel B
0	0	0	0	0	0	1	0	Data[11:4]								Data[3:0]				X	X	X	X	Write to DAC input register of channel C
0	0	0	0	0	0	1	1	Data[11:4]								Data[3:0]				X	X	X	X	Write to DAC input register of channel D
0	0	0	0	0	1	0	0	Data[11:4]								Data[3:0]				X	X	X	X	Write to DAC input register of channel E
0	0	0	0	0	1	0	1	Data[11:4]								Data[3:0]				X	X	X	X	Write to DAC input register of channel F
0	0	0	0	0	1	1	0	Data[11:4]								Data[3:0]				X	X	X	X	Write to DAC input register of channel G
0	0	0	0	0	1	1	1	Data[11:4]								Data[3:0]				X	X	X	X	Write to DAC input register of channel H
0	0	0	0	1	X	X	X	X	X	X	X	X	X	X	X	X	X	X	X	X	X	X	Invalid code, no action performed	
0	0	0	0	1	1	1	1	Data[11:4]								Data[3:0]				X	X	X	X	Broadcast mode, write to all DAC channels
Select DAC Register to Update																								
0	0	0	1	0	0	0	0	X	X	X	X	X	X	X	X	X	X	X	X	X	X	Selects DAC channel A to be updated		
0	0	0	1	0	0	0	1	X	X	X	X	X	X	X	X	X	X	X	X	X	X	Selects DAC channel B to be updated		
0	0	0	1	0	0	1	0	X	X	X	X	X	X	X	X	X	X	X	X	X	X	Selects DAC channel C to be updated		
0	0	0	1	0	0	1	1	X	X	X	X	X	X	X	X	X	X	X	X	X	X	Selects DAC channel D to be updated		
0	0	0	1	0	1	0	0	X	X	X	X	X	X	X	X	X	X	X	X	X	X	Selects DAC channel E to be updated		
0	0	0	1	0	1	0	1	X	X	X	X	X	X	X	X	X	X	X	X	X	X	Selects DAC channel F to be updated		
0	0	0	1	0	1	1	0	X	X	X	X	X	X	X	X	X	X	X	X	X	X	Selects DAC channel G to be updated		
0	0	0	1	0	1	1	1	X	X	X	X	X	X	X	X	X	X	X	X	X	X	Selects DAC channel H to be updated		
0	0	0	1	1	X	X	X	X	X	X	X	X	X	X	X	X	X	X	X	X	X	Invalid code, no action performed		
0	0	0	1	1	1	1	1	X	X	X	X	X	X	X	X	X	X	X	X	X	X	Broadcast mode, selects all DAC channels to be updated		
Write to Selected DAC Input Register and Update Corresponding DAC Register (Individual Software LDAC)																								
0	0	1	1	0	0	0	0	Data[11:4]								Data[3:0]				X	X	X	X	Write to DAC input register for channel A and update channel A DAC register
0	0	1	1	0	0	0	1	Data[11:4]								Data[3:0]				X	X	X	X	Write to DAC input register for channel B and update channel B DAC register
0	0	1	1	0	0	1	0	Data[11:4]								Data[3:0]				X	X	X	X	Write to DAC input register for channel C and update channel C DAC register
0	0	1	1	0	0	1	1	Data[11:4]								Data[3:0]				X	X	X	X	Write to DAC input register for channel D and update channel D DAC register
0	0	1	1	0	1	0	0	Data[11:4]								Data[3:0]				X	X	X	X	Write to DAC input register for channel E and update channel E DAC register
0	0	1	1	0	1	0	1	Data[11:4]								Data[3:0]				X	X	X	X	Write to DAC input register for channel F and update channel F DAC register
0	0	1	1	0	1	1	0	Data[11:4]								Data[3:0]				X	X	X	X	Write to DAC input register for channel G and update channel G DAC register
0	0	1	1	0	1	1	1	Data[11:4]								Data[3:0]				X	X	X	X	Write to DAC input register for channel H and update channel H DAC register

Table 14. Control Matrix for Write Commands (see Table 10, Table 11, and Table 12 for 8-bit, 10-bit, and 12-bit mapping) (continued)

COMMAND AND ACCESS BYTE								MOST SIGNIFICANT DATA BYTE								LEAST SIGNIFICANT DATA BYTE								DESCRIPTION	
C3	C2	C1	C0	A3	A2	A1	A0	DATA[7:0]								X	X	X	X	X	X	X	X	General data format for 8-bit DAC5578	
C3	C2	C1	C0	A3	A2	A1	A0	DATA[9:2]								D1	D0	X	X	X	X	X	X	General data format for 10-bit DAC6578	
C3	C2	C1	C0	A3	A2	A1	A0	DATA[11:4]								D3	D2	D1	D0	X	X	X	X	General data format for 12-bit DAC7578	
0	0	1	1	1	X	X	X	X	X	X	X	X	X	X	X	X	X	X	X	X	X	X	Invalid code, no action performed		
0	0	1	1	1	1	1	1	Data[11:4]								Data[3:0]				X	X	X	X	Broadcast mode, write to all input registers and update all DAC registers	
Write to Selected DAC Input Register and Update All DAC Registers (Global Software LDAC)																									
0	0	1	0	0	0	0	0	Data[11:4]								Data[3:0]				X	X	X	X	Write to DAC input register for channel A and update all DAC registers	
0	0	1	0	0	0	0	1	Data[11:4]								Data[3:0]				X	X	X	X	Write to DAC input register for channel B and update all DAC registers	
0	0	1	0	0	0	1	0	Data[11:4]								Data[3:0]				X	X	X	X	Write to DAC input register for channel C and update all DAC registers	
0	0	1	0	0	0	1	1	Data[11:4]								Data[3:0]				X	X	X	X	Write to DAC input register for channel D and update all DAC registers	
0	0	1	0	0	1	0	0	Data[11:4]								Data[3:0]				X	X	X	X	Write to DAC input register for channel E and update all DAC registers	
0	0	1	0	0	1	0	1	Data[11:4]								Data[3:0]				X	X	X	X	Write to DAC input register for channel F and update all DAC registers	
0	0	1	0	0	1	1	0	Data[11:4]								Data[3:0]				X	X	X	X	Write to DAC input register for channel G and update all DAC registers	
0	0	1	0	0	1	1	1	Data[11:4]								Data[3:0]				X	X	X	X	Write to DAC input register for channel H and update all DAC registers	
0	0	1	0	1	X	X	X	X	X	X	X	X	X	X	X	X	X	X	X	X	X	X	Invalid code, no action performed		
0	0	1	0	1	1	1	1	Data[11:4]								Data[3:0]				X	X	X	X	Broadcast mode, write to all input registers and update all DAC registers	
Power-Down Register																									
0	1	0	0	X	X	X	X	X	PD1	PD0	DAC A	DAC B	DAC C	DAC D	DAC E	DAC F	DAC G	DAC H	X	X	X	X	X		
0	1	0	0	X	X	X	X	X	0	0	DAC A	DAC B	DAC C	DAC D	DAC E	DAC F	DAC G	DAC H	X	X	X	X	X	Each DAC bit set to '1' powers on selected DACs	
0	1	0	0	X	X	X	X	X	0	1	DAC A	DAC B	DAC C	DAC D	DAC E	DAC F	DAC G	DAC H	X	X	X	X	X	Each DAC bit set to '1' powers down selected DACs. V _{OUT} connected to GND through 1kΩ pull-down resistor	
0	1	0	0	X	X	X	X	X	1	0	DAC A	DAC B	DAC C	DAC D	DAC E	DAC F	DAC G	DAC H	X	X	X	X	X	Each DAC bit set to '1' powers down selected DACs. V _{OUT} connected to GND through 100kΩ pull-down resistor	
0	1	0	0	X	X	X	X	X	1	1	DAC A	DAC B	DAC C	DAC D	DAC E	DAC F	DAC G	DAC H	X	X	X	X	X	Each DAC bit set to '1' powers down selected DACs. V _{OUT} is High Z	
Clear Code Register																									
0	1	0	1	X	X	X	X	X	X	X	X	X	X	X	X	X	X	X	CL1	CL0	X	X	X	X	
0	1	0	1	X	X	X	X	X	X	X	X	X	X	X	X	X	X	X	0	0	X	X	X	X	Write to clear code register, CLR pin clears to zero scale
0	1	0	1	X	X	X	X	X	X	X	X	X	X	X	X	X	X	0	1	X	X	X	X	Write to clear code register, CLR pin clears to midscale	
0	1	0	1	X	X	X	X	X	X	X	X	X	X	X	X	X	X	1	0	X	X	X	X	Write to clear code register, CLR pin clears to full scale	
0	1	0	1	X	X	X	X	X	X	X	X	X	X	X	X	X	X	1	1	X	X	X	X	Write to clear code register disables CLR pin	
LDAC Register																									

Table 14. Control Matrix for Write Commands (see Table 10, Table 11, and Table 12 for 8-bit, 10-bit, and 12-bit mapping) (continued)

COMMAND AND ACCESS BYTE								MOST SIGNIFICANT DATA BYTE								LEAST SIGNIFICANT DATA BYTE								DESCRIPTION
C3	C2	C1	C0	A3	A2	A1	A0	DATA[7:0]								X	X	X	X	X	X	X	X	General data format for 8-bit DAC5578
C3	C2	C1	C0	A3	A2	A1	A0	DATA[9:2]								D1	D0	X	X	X	X	X	X	General data format for 10-bit DAC6578
C3	C2	C1	C0	A3	A2	A1	A0	DATA[11:4]								D3	D2	D1	D0	X	X	X	X	General data format for 12-bit DAC7578
0	1	1	0	X	X	X	X	DAC H	DAC G	DAC F	DAC E	DAC D	DAC C	DAC B	DAC A	X	X	X	X	X	X	X	X	When all DAC bits are set to '1', selected DACs ignore the LDAC pin. When all DAC bits are set to '0', selected DAC registers update according to the LDAC pin.
Software Reset																								
0	1	1	1	X	X	X	X	0	0	X	X	X	X	X	X	X	X	X	X	X	X	X	X	Software reset (default). Same as power-on reset (POR).
0	1	1	1	X	X	X	X	0	1	X	X	X	X	X	X	X	X	X	X	X	X	X	X	Software reset that sets device into High-Speed mode
0	1	1	1	X	X	X	X	1	0	X	X	X	X	X	X	X	X	X	X	X	X	X	X	Software reset that maintains High-Speed mode state

Table 15. Control Matrix for Read Commands (see Table 10, Table 11, and Table 12 for 8-bit, 10-bit, and 12-bit mapping)

COMMAND AND ACCESS BYTE								MOST SIGNIFICANT DATA BYTE								LEAST SIGNIFICANT DATA BYTE								DESCRIPTION	
C3	C2	C1	C0	A3	A2	A1	A0	DATA [7:0]								X	X	X	X	X	X	X	X	General data format for 8-bit DAC5578	
C3	C2	C1	C0	A3	A2	A1	A0	DATA [9:2]								D1	D0	X	X	X	X	X	X	General data format for 10-bit DAC6578	
C3	C2	C1	C0	A3	A2	A1	A0	DATA [11:4]								D3	D2	D1	D0	X	X	X	X	General data format for 12-bit DAC7578	
Input Register																									
0	0	0	0	0	0	0	0	Data[11:4]								Data[3:0]				0	0	0	0	Read from DAC input register channel A	
0	0	0	0	0	0	0	1	Data[11:4]								Data[3:0]				0	0	0	0	Read from DAC input register channel B	
0	0	0	0	0	0	1	0	Data[11:4]								Data[3:0]				0	0	0	0	Read from DAC input register channel C	
0	0	0	0	0	0	1	1	Data[11:4]								Data[3:0]				0	0	0	0	Read from DAC input register channel D	
0	0	0	0	0	1	0	0	Data[11:4]								Data[3:0]				0	0	0	0	Read from DAC input register channel E	
0	0	0	0	0	1	0	1	Data[11:4]								Data[3:0]				0	0	0	0	Read from DAC input register channel F	
0	0	0	0	0	1	1	0	Data[11:4]								Data[3:0]				0	0	0	0	Read from DAC input register channel G	
0	0	0	0	0	1	1	1	Data[11:4]								Data[3:0]				0	0	0	0	Read from DAC input register channel H	
0	0	0	0	1	X	X	X	X	X	X	X	X	X	X	X	X	X	X	X	X	X	X	Invalid code		
DAC Register																									
0	0	0	1	0	0	0	0	Data[11:4]								Data[3:0]				0	0	0	0	Read DAC A DAC register	
0	0	0	1	0	0	0	1	Data[11:4]								Data[3:0]				0	0	0	0	Read DAC B DAC register	
0	0	0	1	0	0	1	0	Data[11:4]								Data[3:0]				0	0	0	0	Read DAC C DAC register	
0	0	0	1	0	0	1	1	Data[11:4]								Data[3:0]				0	0	0	0	Read DAC D DAC register	
0	0	0	1	0	1	0	0	Data[11:4]								Data[3:0]				0	0	0	0	Read DAC E DAC register	
0	0	0	1	0	1	0	1	Data[11:4]								Data[3:0]				0	0	0	0	Read DAC F DAC register	
0	0	0	1	0	1	1	0	Data[11:4]								Data[3:0]				0	0	0	0	Read DAC G DAC register	
0	0	0	1	0	1	1	1	Data[11:4]								Data[3:0]				0	0	0	0	Read DAC H DAC register	
0	0	0	1	1	X	X	X	X	X	X	X	X	X	X	X	X	X	X	X	X	X	X	Invalid code		
Power Down Register																									
0	1	0	0	X	X	X	X	0	0	0	0	0	0	0	PD1	PD0	DAC A	DAC B	DAC C	DAC D	DAC E	DAC F	DAC G	DAC H	Read power down register
Clear Code Register																									
0	1	0	1	X	X	X	X	0	0	0	0	0	0	0	0	0	0	0	0	0	0	0	CL1	CL0	Read clear code register
LDAC Register																									
0	1	1	0	X	X	X	X	0	0	0	0	0	0	0	0	0	DAC H	DAC G	DAC F	DAC E	DAC D	DAC C	DAC B	DAC A	Read LDAC register

POWER-ON RESET TO ZERO-SCALE OR MIDSCALE

The DACx578 contains a power-on reset (POR) circuit that controls the output voltage during power-on. For devices in the TSSOP package, at power-on, all DAC registers are filled with zeros and the output voltages of all DAC channels are set to zero-scale. For devices in the QFN package, all DAC registers are set to have all DAC channels power on depending of the state of the RSTSEL pin.

The RSTSEL pin value is read at power-on and should be set prior to or simultaneously with AV_{DD} . For RSTSEL set to AV_{DD} , the DAC channels are loaded with midscale code. If RSTSEL is set to ground, the DAC channels are loaded with zero-scale code. All DAC channels remain in this state until a valid write sequence and load command are sent to the respective DAC channel. The power-on reset function is useful in applications where it is important to know the output state of each DAC while the device is in the process of powering on.

LDAC FUNCTIONALITY

The DACx578 offers both software and hardware simultaneous updates and control functions. The DAC double-buffered architecture is designed so that new data can be entered for each DAC without disturbing the analog outputs.

The DACx578 data updates can be performed either in Synchronous or Asynchronous mode.

In Synchronous mode, data are updated on the falling edge of the acknowledge signal that follows LSDB. For Synchronous mode updates, the \overline{LDAC} pin is not required and must be connected to GND permanently.

In Asynchronous mode, the \overline{LDAC} pin is used as a negative-edge-triggered timing signal for asynchronous DAC updates. Multiple single-channel updates can be performed in order to set different channel buffers to desired values and then make a falling edge on the \overline{LDAC} pin. The data buffers of all the channels must be loaded with the desired data before an \overline{LDAC} falling edge. After a high-to-low \overline{LDAC} transition, all DACs simultaneously update with the last contents of the corresponding data buffers. If the contents of a data buffer are not changed by the serial interface, the corresponding DAC output remains unchanged after the \overline{LDAC} trigger.

Alternatively, all DAC outputs can be updated simultaneously using the built-in LDAC software function. The LDAC register offers additional flexibility and control, giving the ability to select which DAC channel(s) should update simultaneously when the

hardware \overline{LDAC} pin is being brought low. The LDAC register is loaded with an 8-bit word (DB15 to DB8) using control bits C3, C2, C1, and C0. The default value for each bit, and therefore each DAC channel, is zero and the external \overline{LDAC} pin operates in normal mode. If the LDAC register bit for a selected DAC channel is set to '1', that DAC channel ignores the external \overline{LDAC} pin and updates only through the software LDAC command. If, however, the LDAC register bit is set to '0', the DAC channel is controlled by the external \overline{LDAC} pin (default).

This combination of both software and hardware simultaneous update functions is particularly useful in applications where only selective DAC channels are to be updated simultaneously, while the other channels remain unaffected and have synchronous channel updates.

POWER-DOWN COMMANDS

The DACx578 uses four modes of operation. These modes are accessed by using control bits C3, C2, C1, and C0. The control bits must be set to '0100'. When the control bits are set correctly, the four different power-down modes are software programmable by setting bits PD0 (DB13) and PD1 (DB14) in the control register. Table 16 shows how to control the operating mode with data bits PD0 (DB13), and PD1 (DB14). The DACx578 treats the power-down condition as data; all the operational modes are still valid for power down. It is possible to broadcast a power-down condition to all the DACx578s in a system. It is also possible to power-down a channel and update data on other channels. Further, it is possible to write to the DAC register/buffer of the DAC channel that is powered down. When the DAC channel is then powered on, it contains the new value.

When both the PD0 and PD1 bits are set to '0', the device works normally with its typical consumption of 1.02 mA at 5.5V. However, for the three power-down modes, the supply current falls to 0.42 μ A at 5.5V (0.25 μ A at 2.7V). Not only does the supply current fall, but the output stage also switches internally from the output amplifier to a resistor network of known values as shown in Figure 117.

The advantage of this switching is that the output impedance of the device is known while it is in power-down mode. As described in Table 16, there are three different power-down options. V_{OUT} can be connected internally to GND through a 1k Ω resistor, a 100k Ω resistor, or open circuited (High-Z).

For example: C3, C2, C1, and C0 = '0100' and DB14 and DB13 = '11' represent a power-down condition with High-Z output impedance for a selected channel. DB14 and DB13 = '01' represents a power-down condition with 1kΩ output impedance, while DB14 and DB13 = '10' represents a power-down condition with 100kΩ output impedance.

Table 16. DAC Operating Modes

PD1 (DB14)	PD0 (DB13)	DAC OPERATING MODES
0	0	Power on selected DACs
0	1	Power down selected DACs, 1kΩ to GND
1	0	Power down selected DACs, 100kΩ to GND
1	1	Power down selected DACs, High-Z to GND

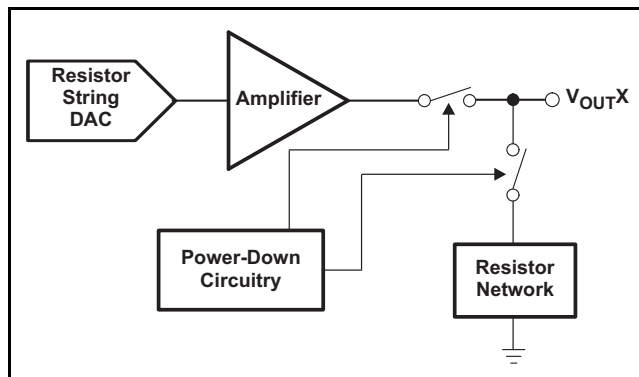

Figure 117. Output Stage During Power-Down

CLEAR CODE REGISTER AND CLR PIN

The DACx578 contains a clear code register. The clear code register can be accessed via the serial interface (I²C) and is user configurable. Bringing the

CLR pin low clears the contents of all DAC registers and all DAC buffers and replaces the code with the code determined by the clear code register. The clear code register can be written to by applying the commands showed in [Table 14](#). The default setting of the clear code register sets the output of all DAC channels to 0V when the CLR pin is brought low. The CLR pin is falling-edge triggered; therefore, the device exits clear code mode on the falling edge of the acknowledge signal that follows LSDB of the next write sequence. If the CLR pin is executed (brought low) during a write sequence, this write sequence is aborted and the DAC registers and DAC buffers are cleared as described above.

When performing a software reset of the device, the clear code register is reset to the default mode (DB5 = '0', DB4 = '0'). Setting the clear code register to DB4 = '1' and DB5 = '1' ignores any activity on the external CLR pin.

SOFTWARE RESET FUNCTION

The DACx578 contains a software reset feature. When the software reset feature is executed, the device (all DAC channels) are reset to the power-on reset code. All registers inside the device are reset to the respective default settings. The DACx578 has an additional feature of switching straight to high speed mode after reset. [Table 17](#) shows all the different modes of the software reset function.

Table 17. Software Reset Modes

DB15	DB14	OPERATING MODES
0	0	Default Software reset. Equivalent to Power-on-Reset
x	1	Software reset and set part in High Speed Mode
1	0	Software reset and maintain High Speed Mode state

OPERATING EXAMPLES: DAC7578

For the following examples X = don't care; value can be either '0' or '1'.

I²C Standard and Fast mode examples (ADDR0 and LDAC pin tied low) (TSSOP package)

Example 1: Write Mid Scale to Data Buffer A and Update Channel A Output

Start	Address	ACK	Command and Access Byte	ACK	MSDB	ACK	LSDB	ACK	Stop
S	1001 0000		0000 0000		1000 0000		0000 XXXX		P

Channel A updates to Mid Scale after the falling edge of the last ACK cycle

Example 2: Power-Down Channel B, C, and H with Hi-Z Output

Start	Address	ACK	Command and Access Byte	ACK	MSDB	ACK	LSDB	ACK	Stop
S	1001 0000		0100 XXXX		X111 0000		110X XXXX		P

Example 3: Read-back the value of the input register of DAC Channel G

Start	Address	ACK	Command and Access Byte	ACK	Repeated Start	Address	ACK	MSDB (from DAC7578)	ACK	LSDB (from DAC7578)
S	1001 0000		0000 0110		Sr	1001 0001		XXXX XXXX		XXXX 0000

Example 4: Write multiple bytes of data to Channel F. Write Full Scale and then Quarter Scale to Channel F

Start	Address	ACK	Command and Access Byte	ACK	MSDB	ACK	LSDB	ACK*	MSDB	ACK	LSDB	ACK**	Stop
S	1001 0000		0000 0101		1111 1111		1111 XXXX		0100 0000		0000 XXXX		P

Channel F updates to Full Scale after the falling edge of the 4th ACK* cycle and then Channel F updates to quarter scale after falling edge of the last ACK** cycle.

I²C High Speed mode example (ADDR0 and LDAC pin tied low) (TSSOP package)

Example 5: Write Mid Scale and then Full Scale to all DAC channels.

Start	HS Master Code	NOT ACK	Repeated Start	Address	ACK	Command and Access Byte	ACK	MSDB	ACK	LSDB	ACK	MSDB	ACK	LSDB	ACK	Stop
S	0000 1000		Sr	1001 0000		0011 1111		1000 0000		0000 XXXX		1111 1111		1111 XXXX		P

All Channels update to Mid Scale after the falling edge of the 4th ACK cycle and then all Channels update to Full scale after falling edge of the last ACK cycle.

APPLICATION INFORMATION

DAC NOISE PERFORMANCE

Output noise spectral density at the V_{OUTX} pin versus frequency is depicted in Figure 55 for full-scale, midscale, and zero-scale input codes. The typical noise density reduces to 104nV/√Hz at 1kHz for mid scale code with external reference as shown in Figure 55. Integrated output noise between 0.1Hz and 10Hz is close to 3μV_{PP} (midscale), as shown in Figure 56.

BIPOLAR OPERATION USING THE DACx578

The DACx578 family of products is designed for single-supply operation, but a bipolar output range is also possible using the circuit in either Figure 118. Rail-to-rail operation at the amplifier output is achievable using an OPA703 as the output amplifier.

The output voltage for any input code can be calculated with Equation 2.

$$V_{OUT} = \left(V_{REF} \times \text{Gain} \times \left(\frac{D_{IN}}{2^n} \right) \times \left(\frac{R_1 + R_2}{R_1} \right) - V_{REF} \times \left(\frac{R_2}{R_1} \right) \right) \quad (2)$$

Where:

D_{IN} = decimal equivalent of the binary code that is loaded to the DAC register. It can range from 0 to 4095 (12 bit), 0 to 1023 (10 bit), and 0 to 255 (8 bit)

n = resolution in bits

Gain = 1

$$V_{OUT} = \left(\frac{10 \times D_{IN}}{2^n} \right) - 5V \quad (3)$$

This result has an output voltage range of ±5V with 000h corresponding to a -5V output and FFFh corresponding to a +5V output for the 12 bit DAC7578.

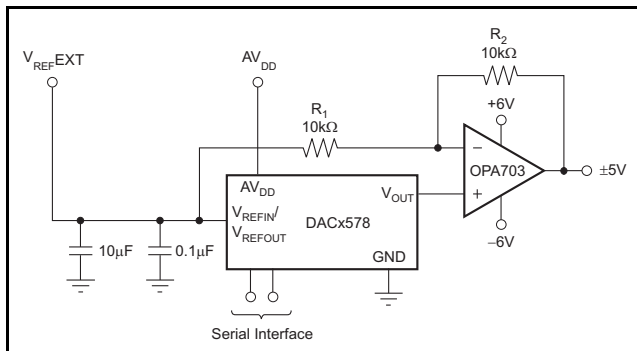

Figure 118. Bipolar Output Range Using External Reference at 5V

MICROPROCESSOR INTERFACING

A basic connection diagram to the SCL and SDA pins of the DACx578 is shown in Figure 119. The DACx578 interfaces directly to standard mode, fast mode and high speed mode of 2-Wire compatible serial interfaces. The DACx578 does not perform clock stretching (pulling SCL low), as a result it is not necessary to provide for this function unless other devices on the same bus require this function. Pull-up resistors are required on both the SDA and SCL lines as the bus-drivers are open-drain. The size of these pull-up resistors depends on the operating speed and capacitance of the bus lines. Higher value resistors consume less power but increase transition time on the bus limiting the bus speed. Long bus lines have higher capacitance and require smaller pull-up resistors to compensate. The resistors should not be too small; if they are, bus drivers may not be able to pull the bus lines low.

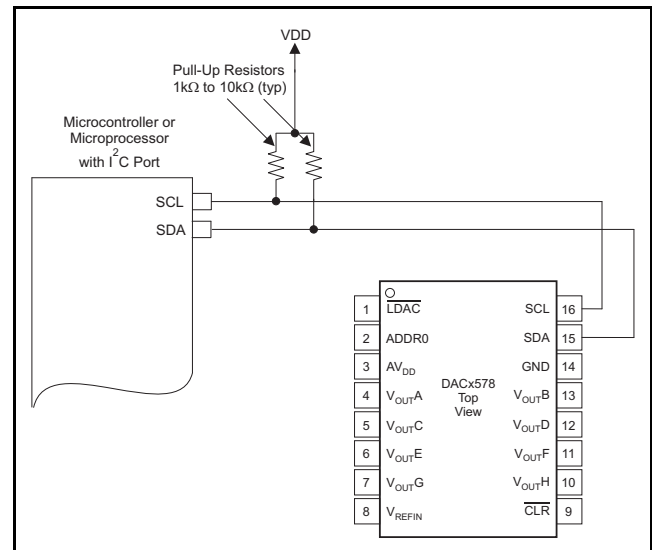

Figure 119. Typical Connections of the DACx578

CONNECTING MULTIPLE DEVICES

Multiple devices of DACx578 family can be connected on the same bus. Using the address pin, the DACx578 can be set to one of three different I²C addresses for the TSSOP package and one of eight addresses for the QFN package. An example showing three DACx578 devices in TSSOP package is shown in Figure 120. Note that only one set of pull-up resistors is needed per bus. The pull-up resistor values may need to be lowered slightly to compensate for the additional bus capacitance due to multiple devices and increased bus length.

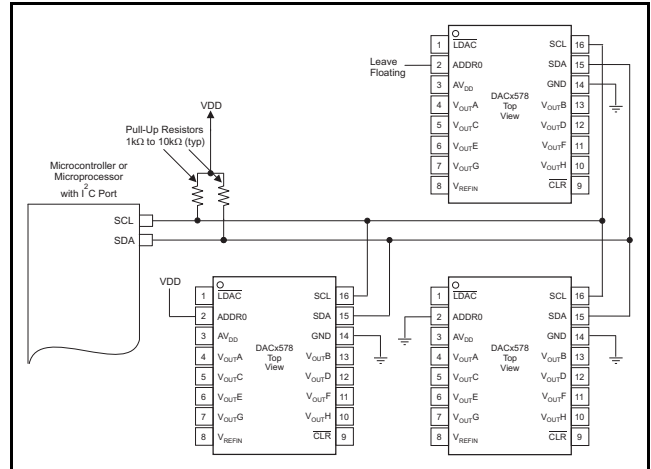

Figure 120. Typical Connections of the Multiple DACx578 on the Same Bus

PARAMETER DEFINITIONS

With the increased complexity of many different specifications listed in product data sheets, this section summarizes selected specifications related to digital-to-analog converters.

STATIC PERFORMANCE

Static performance parameters are specifications such as differential nonlinearity (DNL) or integral nonlinearity (INL). These are dc specifications and provide information on the accuracy of the DAC. They are most important in applications where the signal changes slowly and accuracy is required.

Resolution

Generally, the DAC resolution can be expressed in different forms. Specifications such as IEC 60748-4 recognize the numerical, analog, and relative resolution. The numerical resolution is defined as the number of digits in the chosen numbering system necessary to express the total number of steps of the transfer characteristic, where a step represents both a digital input code and the corresponding discrete analogue output value. The most commonly-used definition of resolution provided in data sheets is the numerical resolution expressed in bits.

Least Significant Bit (LSB)

The least significant bit (LSB) is defined as the smallest value in a binary coded system. The value of the LSB can be calculated by dividing the full-scale output voltage by 2^n , where n is the resolution of the converter.

Most Significant Bit (MSB)

The most significant bit (MSB) is defined as the largest value in a binary coded system. The value of the MSB can be calculated by dividing the full-scale output voltage by 2. Its value is one-half of full-scale.

Relative Accuracy or Integral Nonlinearity (INL)

Relative accuracy or integral nonlinearity (INL) is defined as the maximum deviation between the real transfer function and a straight line passing through the endpoints of the ideal DAC transfer function. INL is measured in LSBs.

Differential Nonlinearity (DNL)

Differential nonlinearity (DNL) is defined as the maximum deviation of the real LSB step from the ideal 1LSB step. Ideally, any two adjacent digital codes correspond to output analog voltages that are exactly one LSB apart. If the DNL is less than 1LSB, the DAC is said to be monotonic.

Full-Scale Error

Full-scale error is defined as the deviation of the real full-scale output voltage from the ideal output voltage while the DAC register is loaded with the full-scale code (for example, for 12 bit resolution 0xFFF). Ideally, the output should be $AVDD - 1 \text{ LSB}$. The full-scale error is expressed in percent of full-scale range (%FSR).

Offset Error

The offset error is defined as the difference between actual output voltage and the ideal output voltage in the linear region of the transfer function. This difference is calculated by using a straight line defined by two codes (for example, for 12 bit resolution code 30 and 4050). Since the offset error is defined by a straight line, it can have a negative or positive value. Offset error is measured in mV.

Zero-Code Error

The zero-code error is defined as the DAC output voltage, when all '0's are loaded into the DAC register. Zero-scale error is a measure of the difference between actual output voltage and ideal output voltage (0V). It is expressed in mV. It is primarily caused by offsets in the output amplifier.

Gain Error

Gain error is defined as the deviation in the slope of the real DAC transfer characteristic from the ideal transfer function. Gain error is expressed as a percentage of full-scale range (%FSR).

Full-Scale Error Drift

Full-scale error drift is defined as the change in full-scale error with a change in temperature. Full-scale error drift is expressed in units of $\mu\text{V}/^\circ\text{C}$.

Offset Error Drift

Offset error drift is defined as the change in offset error with a change in temperature. Offset error drift is expressed in $\mu\text{V}/^\circ\text{C}$.

Zero-Code Error Drift

Zero-code error drift is defined as the change in zero-code error with a change in temperature. Zero-code error drift is expressed in $\mu\text{V}/^\circ\text{C}$.

Gain Temperature Coefficient

The gain temperature coefficient is defined as the change in gain error with changes in temperature. The gain temperature coefficient is expressed in ppm of FSR/ $^\circ\text{C}$.

Power-Supply Rejection Ratio (PSRR)

Power-supply rejection ratio (PSRR) is defined as the ratio of change in output voltage to a change in supply voltage for a full-scale output of the DAC. The PSRR of a device indicates how the output of the DAC is affected by changes in the supply voltage. PSRR is measured in decibels (dB).

Monotonicity

Monotonicity is defined as a slope whose sign does not change. If a DAC is monotonic, the output changes in the same direction or remains at least constant for each step increase (or decrease) in the input code.

DYNAMIC PERFORMANCE

Dynamic performance parameters are specifications such as settling time or slew rate, which are important in applications where the signal rapidly changes and/or high frequency signals are present.

Slew Rate

The output slew rate (SR) of an amplifier or other electronic circuit is defined as the maximum rate of change of the output voltage for all possible input signals.

$$SR = \max \left(\left| \frac{\Delta V_{OUT}(t)}{\Delta t} \right| \right)$$

Where $\Delta V_{OUT}(t)$ is the output produced by the amplifier as a function of time t .

Output Voltage Settling Time

Settling time is the total time (including slew time) for the DAC output to settle within an error band around its final value after a change in input. Settling times are specified to within $\pm 0.003\%$ (or whatever value is specified) of full-scale range (FSR).

Code Change/Digital-to-Analog Glitch Energy

Digital-to-analog glitch impulse is the impulse injected into the analog output when the input code in the DAC register changes state. It is normally specified as the area of the glitch in nanovolt-seconds (nV-s), and is measured when the digital input code is changed by 1LSB at the major carry transition.

Digital Feed-through

Digital feed-through is defined as impulse seen at the output of the DAC from the digital inputs of the DAC. It is measured when the DAC output is not updated. It is specified in nV-s, and measured with a full-scale code change on the data bus; that is, from all '0's to all '1's and vice versa.

Channel-to-Channel DC Crosstalk

Channel-to-channel dc crosstalk is defined as the dc change in the output level of one DAC channel in response to a change in the output of another DAC channel. It is measured with a full-scale output change on one DAC channel while monitoring another DAC channel remains at midscale. It is expressed in LSB.

DAC Output Noise Density

Output noise density is defined as internally-generated random noise. Random noise is characterized as a spectral density (nV/ $\sqrt{\text{Hz}}$). It is measured by loading the DAC to midscale and measuring noise at the output.

DAC Output Noise

DAC output noise is defined as any voltage deviation of DAC output from the desired value (within a particular frequency band). It is measured with a DAC channel kept at midscale while filtering the output voltage within a band of 0.1Hz to 10Hz and measuring its amplitude peaks. It is expressed in terms of peak-to-peak voltage (V_{pp}).

Full-Scale Range (FSR)

Full-scale range (FSR) is the difference between the maximum and minimum analog output values that the DAC is specified to provide; typically, the maximum and minimum values are also specified. For an n -bit DAC, these values are usually given as the values matching with code 0 and $2^n - 1$.

LAYOUT

A precision analog component requires careful layout, adequate bypassing, and clean, well-regulated power supplies. The DACx578 offers single-supply operation, and is often used in close proximity with digital logic, microcontrollers, microprocessors, and digital signal processors. The more digital logic present in the design and the higher the switching speed, the more difficult it is to keep digital noise from appearing at the output. As a result of the single ground pin of the DACx578, all return currents (including digital and analog return currents for the DAC) must flow through a single point. Ideally, GND would be connected directly to an analog ground plane. This plane would be separate from the ground connection for the digital components until they were connected at the power-entry point of the system.

The power applied to AVDD should be well-regulated and low noise. Switching power supplies and dc/dc converters often have high-frequency glitches or spikes riding on the output voltage. In addition, digital components can create similar high-frequency spikes as their internal logic switches states. This noise can easily couple into the DAC output voltage through various paths between the power connections and analog output. As with the GND connection, AVDD should be connected to a power-supply plane or trace that is separate from the connection for digital logic until they are connected at the power-entry point. In addition, a 1 μ F to 10 μ F capacitor and 0.1 μ F bypass capacitor are strongly recommended. In some situations, additional bypassing may be required, such as a 100 μ F electrolytic capacitor or even a Pi filter made up of inductors and capacitors – all designed to essentially low-pass filter the supply and remove the high-frequency noise.

REVISION HISTORY

Changes from Original (March 2010) to Revision A **Page**

- Changed Changed the data sheet From: Product Preview To: Production Data. 1
-

RGE (S-PVQFN-N24)

PLASTIC QUAD FLATPACK NO-LEAD

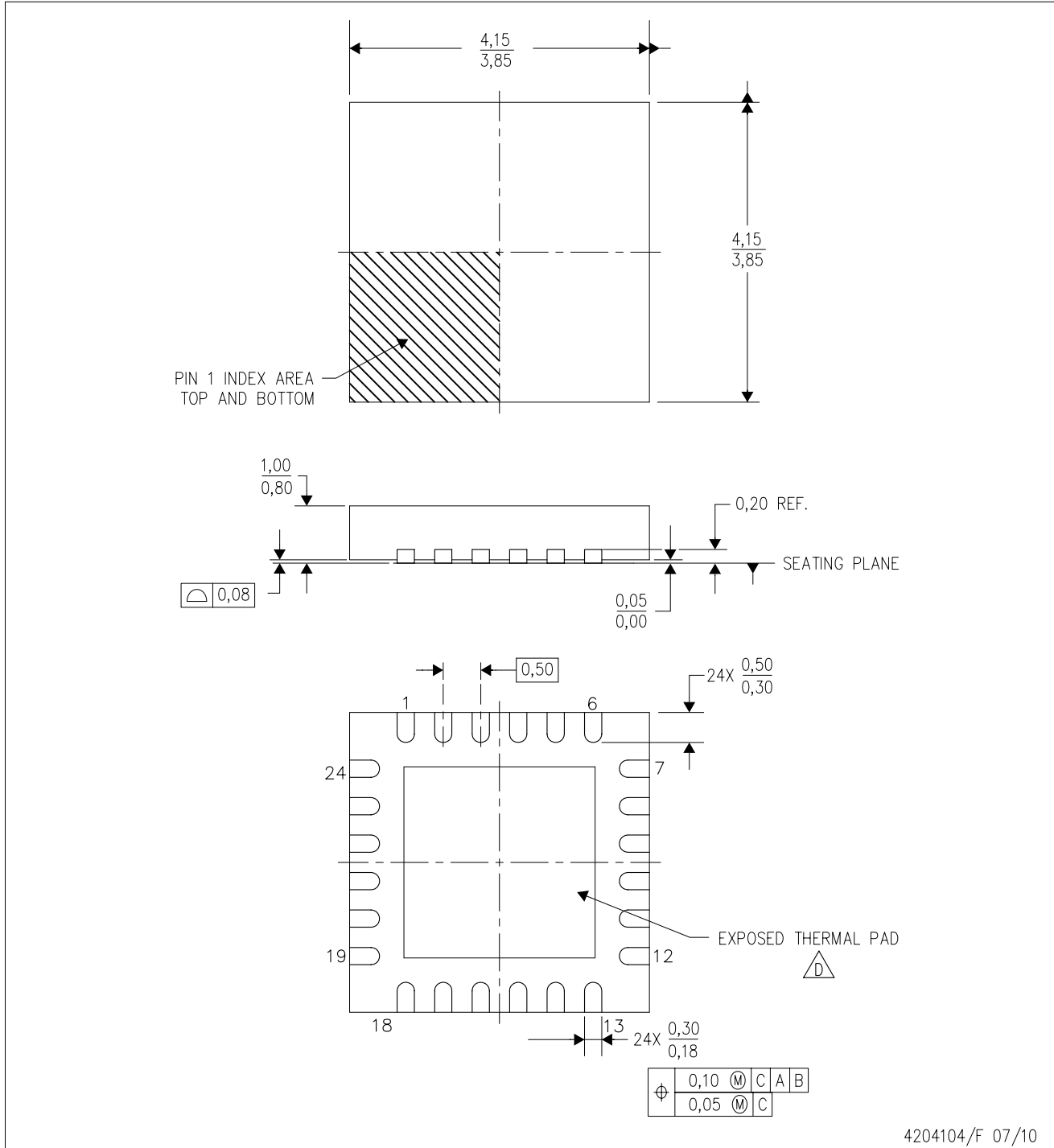

4204104/F 07/10

- NOTES:
- A. All linear dimensions are in millimeters. Dimensioning and tolerancing per ASME Y14.5M-1994.
 - B. This drawing is subject to change without notice.
 - C. Quad Flatpack, No-Leads (QFN) package configuration.
 -  The package thermal pad must be soldered to the board for thermal and mechanical performance. See the Product Data Sheet for details regarding the exposed thermal pad dimensions.
 - E. Falls within JEDEC MO-220.

THERMAL PAD MECHANICAL DATA

RGE (S-PVQFN-N24)

PLASTIC QUAD FLATPACK NO-LEAD

THERMAL INFORMATION

This package incorporates an exposed thermal pad that is designed to be attached directly to an external heatsink. The thermal pad must be soldered directly to the printed circuit board (PCB). After soldering, the PCB can be used as a heatsink. In addition, through the use of thermal vias, the thermal pad can be attached directly to the appropriate copper plane shown in the electrical schematic for the device, or alternatively, can be attached to a special heatsink structure designed into the PCB. This design optimizes the heat transfer from the integrated circuit (IC).

For information on the Quad Flatpack No-Lead (QFN) package and its advantages, refer to Application Report, QFN/SON PCB Attachment, Texas Instruments Literature No. SLUA271. This document is available at www.ti.com.

The exposed thermal pad dimensions for this package are shown in the following illustration.

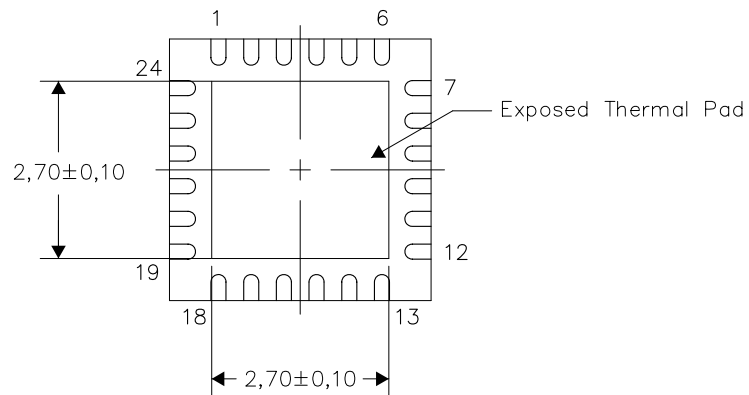

Bottom View

NOTE: All linear dimensions are in millimeters

Exposed Thermal Pad Dimensions

4206344-4/T 07/10

RGE (S-PVQFN-N24)

PLASTIC QUAD FLATPACK NO-LEAD

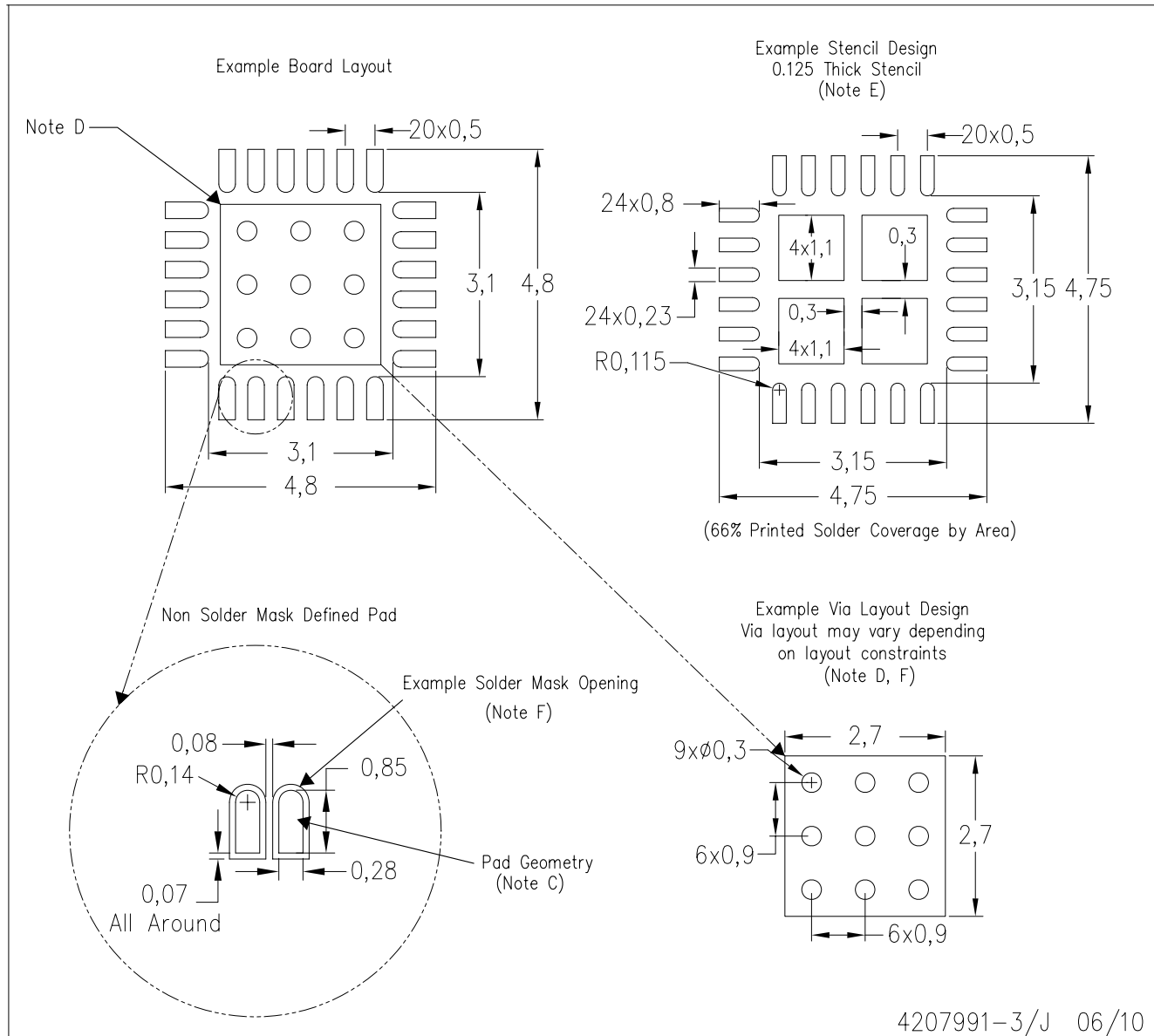

- NOTES:
- All linear dimensions are in millimeters.
 - This drawing is subject to change without notice.
 - Publication IPC-7351 is recommended for alternate designs.
 - This package is designed to be soldered to a thermal pad on the board. Refer to Application Note, Quad Flat-Pack Packages, Texas Instruments Literature No. SLUA271, and also the Product Data Sheets for specific thermal information, via requirements, and recommended board layout. These documents are available at www.ti.com <<http://www.ti.com>>.
 - Laser cutting apertures with trapezoidal walls and also rounding corners will offer better paste release. Customers should contact their board assembly site for stencil design recommendations. Refer to IPC 7525 for stencil design considerations.
 - Customers should contact their board fabrication site for recommended solder mask tolerances and via tenting recommendations for vias placed in the thermal pad.

PW (R-PDSO-G**)

PLASTIC SMALL-OUTLINE PACKAGE

14 PINS SHOWN



4040064/F 01/97

- NOTES: A. All linear dimensions are in millimeters.
 B. This drawing is subject to change without notice.
 C. Body dimensions do not include mold flash or protrusion not to exceed 0,15.
 D. Falls within JEDEC MO-153

PACKAGING INFORMATION

Orderable Device	Status ⁽¹⁾	Package Type	Package Drawing	Pins	Package Qty	Eco Plan ⁽²⁾	Lead/ Ball Finish	MSL Peak Temp ⁽³⁾	Samples (Requires Login)
DAC5578SPW	ACTIVE	TSSOP	PW	16	90	Green (RoHS & no Sb/Br)	CU NIPDAU	Level-3-260C-168 HR	Request Free Samples
DAC5578SPWR	ACTIVE	TSSOP	PW	16	2000	Green (RoHS & no Sb/Br)	CU NIPDAU	Level-3-260C-168 HR	Purchase Samples
DAC5578SRGER	ACTIVE	VQFN	RGE	24	3000	Green (RoHS & no Sb/Br)	CU NIPDAU	Level-3-260C-168 HR	Purchase Samples
DAC5578SRGET	ACTIVE	VQFN	RGE	24	250	Green (RoHS & no Sb/Br)	CU NIPDAU	Level-3-260C-168 HR	Request Free Samples
DAC6578SPW	ACTIVE	TSSOP	PW	16	90	Green (RoHS & no Sb/Br)	CU NIPDAU	Level-3-260C-168 HR	Request Free Samples
DAC6578SPWR	ACTIVE	TSSOP	PW	16	2000	Green (RoHS & no Sb/Br)	CU NIPDAU	Level-3-260C-168 HR	Purchase Samples
DAC6578SRGER	ACTIVE	VQFN	RGE	24	3000	Green (RoHS & no Sb/Br)	CU NIPDAU	Level-3-260C-168 HR	Purchase Samples
DAC6578SRGET	ACTIVE	VQFN	RGE	24	250	Green (RoHS & no Sb/Br)	CU NIPDAU	Level-3-260C-168 HR	Request Free Samples
DAC7578SPW	ACTIVE	TSSOP	PW	16	90	Green (RoHS & no Sb/Br)	CU NIPDAU	Level-3-260C-168 HR	Request Free Samples
DAC7578SPWR	ACTIVE	TSSOP	PW	16	2000	Green (RoHS & no Sb/Br)	CU NIPDAU	Level-3-260C-168 HR	Purchase Samples
DAC7578SRGER	ACTIVE	VQFN	RGE	24	3000	Green (RoHS & no Sb/Br)	CU NIPDAU	Level-3-260C-168 HR	Purchase Samples
DAC7578SRGET	ACTIVE	VQFN	RGE	24	250	Green (RoHS & no Sb/Br)	CU NIPDAU	Level-3-260C-168 HR	Request Free Samples

⁽¹⁾ The marketing status values are defined as follows:

ACTIVE: Product device recommended for new designs.

LIFEBUY: TI has announced that the device will be discontinued, and a lifetime-buy period is in effect.

NRND: Not recommended for new designs. Device is in production to support existing customers, but TI does not recommend using this part in a new design.

PREVIEW: Device has been announced but is not in production. Samples may or may not be available.

OBSOLETE: TI has discontinued the production of the device.

⁽²⁾ Eco Plan - The planned eco-friendly classification: Pb-Free (RoHS), Pb-Free (RoHS Exempt), or Green (RoHS & no Sb/Br) - please check <http://www.ti.com/productcontent> for the latest availability information and additional product content details.

TBD: The Pb-Free/Green conversion plan has not been defined.

Pb-Free (RoHS): TI's terms "Lead-Free" or "Pb-Free" mean semiconductor products that are compatible with the current RoHS requirements for all 6 substances, including the requirement that lead not exceed 0.1% by weight in homogeneous materials. Where designed to be soldered at high temperatures, TI Pb-Free products are suitable for use in specified lead-free processes.

Pb-Free (RoHS Exempt): This component has a RoHS exemption for either 1) lead-based flip-chip solder bumps used between the die and package, or 2) lead-based die adhesive used between the die and leadframe. The component is otherwise considered Pb-Free (RoHS compatible) as defined above.

Green (RoHS & no Sb/Br): TI defines "Green" to mean Pb-Free (RoHS compatible), and free of Bromine (Br) and Antimony (Sb) based flame retardants (Br or Sb do not exceed 0.1% by weight in homogeneous material)

⁽³⁾ MSL, Peak Temp. -- The Moisture Sensitivity Level rating according to the JEDEC industry standard classifications, and peak solder temperature.

Important Information and Disclaimer: The information provided on this page represents TI's knowledge and belief as of the date that it is provided. TI bases its knowledge and belief on information provided by third parties, and makes no representation or warranty as to the accuracy of such information. Efforts are underway to better integrate information from third parties. TI has taken and continues to take reasonable steps to provide representative and accurate information but may not have conducted destructive testing or chemical analysis on incoming materials and chemicals. TI and TI suppliers consider certain information to be proprietary, and thus CAS numbers and other limited information may not be available for release.

In no event shall TI's liability arising out of such information exceed the total purchase price of the TI part(s) at issue in this document sold by TI to Customer on an annual basis.

TAPE AND REEL INFORMATION

QUADRANT ASSIGNMENTS FOR PIN 1 ORIENTATION IN TAPE

*All dimensions are nominal

Device	Package Type	Package Drawing	Pins	SPQ	Reel Diameter (mm)	Reel Width W1 (mm)	A0 (mm)	B0 (mm)	K0 (mm)	P1 (mm)	W (mm)	Pin1 Quadrant
DAC5578SPWR	TSSOP	PW	16	2000	330.0	12.4	6.9	5.6	1.6	8.0	12.0	Q1
DAC5578SRGER	VQFN	RGE	24	3000	330.0	12.4	4.25	4.25	1.15	8.0	12.0	Q2
DAC5578SRGET	VQFN	RGE	24	250	180.0	12.4	4.25	4.25	1.15	8.0	12.0	Q2
DAC6578SPWR	TSSOP	PW	16	2000	330.0	12.4	6.9	5.6	1.6	8.0	12.0	Q1
DAC6578SRGER	VQFN	RGE	24	3000	330.0	12.4	4.25	4.25	1.15	8.0	12.0	Q2
DAC6578SRGET	VQFN	RGE	24	250	180.0	12.4	4.25	4.25	1.15	8.0	12.0	Q2
DAC7578SPWR	TSSOP	PW	16	2000	330.0	12.4	6.9	5.6	1.6	8.0	12.0	Q1
DAC7578SRGER	VQFN	RGE	24	3000	330.0	12.4	4.25	4.25	1.15	8.0	12.0	Q2
DAC7578SRGET	VQFN	RGE	24	250	180.0	12.4	4.25	4.25	1.15	8.0	12.0	Q2

TAPE AND REEL BOX DIMENSIONS

*All dimensions are nominal

Device	Package Type	Package Drawing	Pins	SPQ	Length (mm)	Width (mm)	Height (mm)
DAC5578SPWR	TSSOP	PW	16	2000	346.0	346.0	29.0
DAC5578SRGER	VQFN	RGE	24	3000	346.0	346.0	29.0
DAC5578SRGET	VQFN	RGE	24	250	190.5	212.7	31.8
DAC6578SPWR	TSSOP	PW	16	2000	346.0	346.0	29.0
DAC6578SRGER	VQFN	RGE	24	3000	346.0	346.0	29.0
DAC6578SRGET	VQFN	RGE	24	250	190.5	212.7	31.8
DAC7578SPWR	TSSOP	PW	16	2000	346.0	346.0	29.0
DAC7578SRGER	VQFN	RGE	24	3000	346.0	346.0	29.0
DAC7578SRGET	VQFN	RGE	24	250	190.5	212.7	31.8

IMPORTANT NOTICE

Texas Instruments Incorporated and its subsidiaries (TI) reserve the right to make corrections, modifications, enhancements, improvements, and other changes to its products and services at any time and to discontinue any product or service without notice. Customers should obtain the latest relevant information before placing orders and should verify that such information is current and complete. All products are sold subject to TI's terms and conditions of sale supplied at the time of order acknowledgment.

TI warrants performance of its hardware products to the specifications applicable at the time of sale in accordance with TI's standard warranty. Testing and other quality control techniques are used to the extent TI deems necessary to support this warranty. Except where mandated by government requirements, testing of all parameters of each product is not necessarily performed.

TI assumes no liability for applications assistance or customer product design. Customers are responsible for their products and applications using TI components. To minimize the risks associated with customer products and applications, customers should provide adequate design and operating safeguards.

TI does not warrant or represent that any license, either express or implied, is granted under any TI patent right, copyright, mask work right, or other TI intellectual property right relating to any combination, machine, or process in which TI products or services are used. Information published by TI regarding third-party products or services does not constitute a license from TI to use such products or services or a warranty or endorsement thereof. Use of such information may require a license from a third party under the patents or other intellectual property of the third party, or a license from TI under the patents or other intellectual property of TI.

Reproduction of TI information in TI data books or data sheets is permissible only if reproduction is without alteration and is accompanied by all associated warranties, conditions, limitations, and notices. Reproduction of this information with alteration is an unfair and deceptive business practice. TI is not responsible or liable for such altered documentation. Information of third parties may be subject to additional restrictions.

Resale of TI products or services with statements different from or beyond the parameters stated by TI for that product or service voids all express and any implied warranties for the associated TI product or service and is an unfair and deceptive business practice. TI is not responsible or liable for any such statements.

TI products are not authorized for use in safety-critical applications (such as life support) where a failure of the TI product would reasonably be expected to cause severe personal injury or death, unless officers of the parties have executed an agreement specifically governing such use. Buyers represent that they have all necessary expertise in the safety and regulatory ramifications of their applications, and acknowledge and agree that they are solely responsible for all legal, regulatory and safety-related requirements concerning their products and any use of TI products in such safety-critical applications, notwithstanding any applications-related information or support that may be provided by TI. Further, Buyers must fully indemnify TI and its representatives against any damages arising out of the use of TI products in such safety-critical applications.

TI products are neither designed nor intended for use in military/aerospace applications or environments unless the TI products are specifically designated by TI as military-grade or "enhanced plastic." Only products designated by TI as military-grade meet military specifications. Buyers acknowledge and agree that any such use of TI products which TI has not designated as military-grade is solely at the Buyer's risk, and that they are solely responsible for compliance with all legal and regulatory requirements in connection with such use.

TI products are neither designed nor intended for use in automotive applications or environments unless the specific TI products are designated by TI as compliant with ISO/TS 16949 requirements. Buyers acknowledge and agree that, if they use any non-designated products in automotive applications, TI will not be responsible for any failure to meet such requirements.

Following are URLs where you can obtain information on other Texas Instruments products and application solutions:

Products		Applications	
Amplifiers	amplifier.ti.com	Audio	www.ti.com/audio
Data Converters	dataconverter.ti.com	Automotive	www.ti.com/automotive
DLP® Products	www.dlp.com	Communications and Telecom	www.ti.com/communications
DSP	dsp.ti.com	Computers and Peripherals	www.ti.com/computers
Clocks and Timers	www.ti.com/clocks	Consumer Electronics	www.ti.com/consumer-apps
Interface	interface.ti.com	Energy	www.ti.com/energy
Logic	logic.ti.com	Industrial	www.ti.com/industrial
Power Mgmt	power.ti.com	Medical	www.ti.com/medical
Microcontrollers	microcontroller.ti.com	Security	www.ti.com/security
RFID	www.ti-rfid.com	Space, Avionics & Defense	www.ti.com/space-avionics-defense
RF/IF and ZigBee® Solutions	www.ti.com/lprf	Video and Imaging	www.ti.com/video
		Wireless	www.ti.com/wireless-apps