

Magnetically Compensated Choke, 1- and 3-phase



Description

- Current compensated choke
- 1- or 3-phase choke
- THT terminals or wire leads
- Flange for mounting onto printed circuit board
- Fully potted resin

Standards

- EN 60938
- IEC 60950
- T.2
- VDE 0565

Applications

- Attenuation of common mode interferences
- May also be used in direct current applications where magnetic compensation is required
- Designed for 230/400 VAC applications

References

Weblinks

[General Product Information](#), [Approvals](#), [RoHS](#), [CHINA-RoHS](#), [e-Store](#), [SCHURTER-Stock-Check](#), [Distributor-Stock-Check](#)

Technical Data

Rated voltage	up to 440 VAC
Rated Current	0.5 - 15 A @ Ta 40 °C
Rated inductance	1 - 20 mH, Tol. -30% +50%
Power Operating Frequency	50 - 400 Hz
Terminal technic	THT, Flexible wire
Weight	6 - 163 g
Material: Housing	UL 94V-0
Sealing Compound	UL 94V-0

Test Voltage	1.8 kV, 50 Hz, 1 min, winding to winding
Isolation Voltage	2 kV eff., winding to ambient
Climatic Category	25/100/21 acc. to IEC 60068-1
Allowable Operation Temp.	-25 °C to 100 °C

Dimensions

Case 03

Case 07

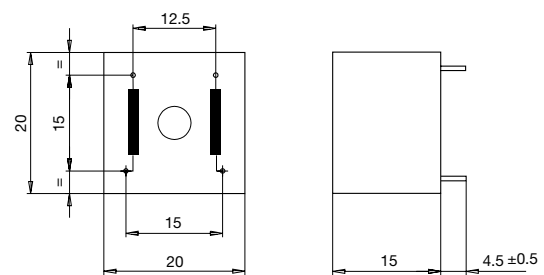
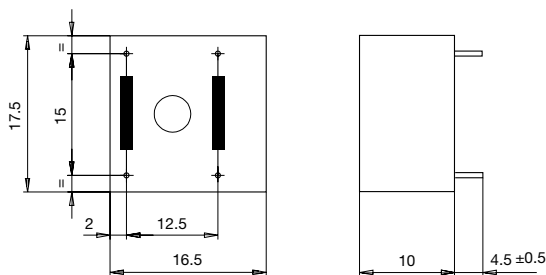

Case 11

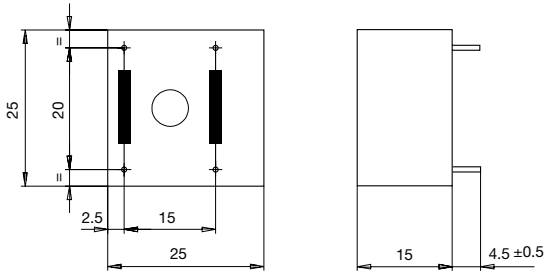

Case 12

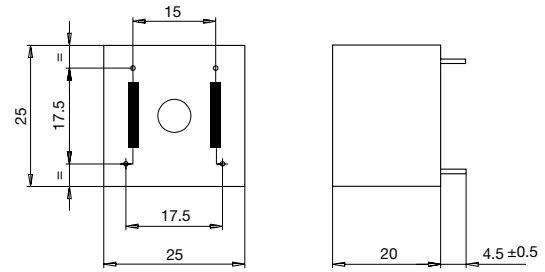

Case 20

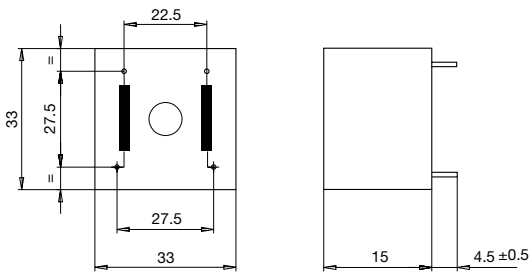

Case 25-2

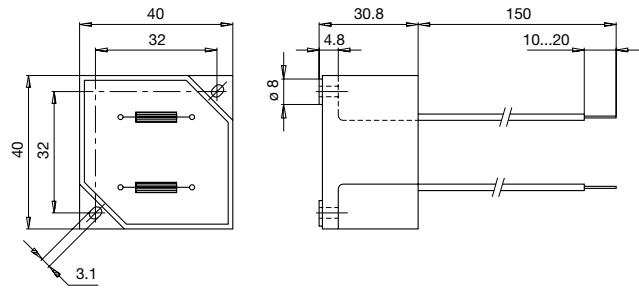

Case 29-4

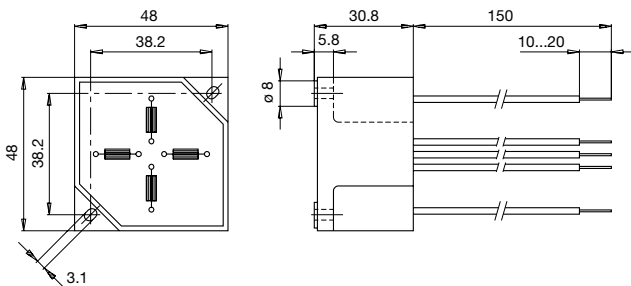

Diagrams

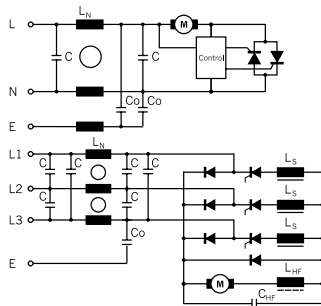

L_N: Radio interference suppression choke (magnetically compensated DF)
 L_S: Radio interference suppression choke (magnetically saturated DFS/DFL)

Variants

I _n [A]	L _n [mH]	R _{cu} [mΩ]	f _{RES} [MHz]	Copper ø [mm]	Weight [g]	Housing	Packing unit	Order Number
0.5	10	900	0.5	0.5	6	03	100	DFK-
1	10	500	0.7	0.6	12	07	150	DFK-20-
1	20	500	0.5	0.6	12	07	150	DFK-20-
1	10	510	0.5	0.6	18	11	50	DFK-25-
2	10	250	0.5	0.6	18	12	50	DFK-25-
2	20	250	0.3	0.6	37	20	45	DFK-33-
3	10	150	0.38	0.6	37	20	45	DFK-33-
6	4	27	0.4	-	127	25-2	10	DFK-40-
10	2	9	1.45	-	127	25-2	10	DFK-40-
15	1	10	1.45	2.5 x 2.5	127	25-2	10	DFK-40-
6	4 x 1.5	20	0.2	1.5 x 1.5	163	29-4	10	DFK-48-