

Miniature Glass Passivated Ultrafast Bridge Rectifier

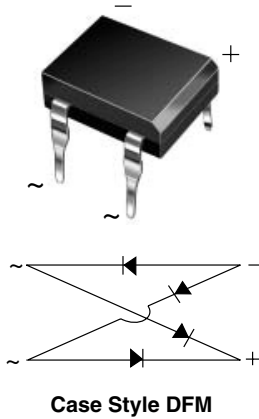

FEATURES

- UL recognition, file number E54214
- Ideal for printed circuit boards
- Ultrafast reverse recovery time for high frequency
- Applicable for automotive insertion
- High surge current capability
- Solder dip 260 °C, 40 s
- Component in accordance to RoHS 2002/95/EC and WEEE 2002/96/EC

RoHS
COMPLIANT

TYPICAL APPLICATIONS

General purpose use in ac-to-dc bridge full wave rectification for SMPS, lighting ballaster, adapter, battery charger, home appliances, office equipment, and telecommunication applications.

MECHANICAL DATA

Case: DFM

Epoxy meets UL 94V-0 flammability rating

Terminals: Matte tin plated leads, solderable per J-STD-002 and JESD22-B102

E3 suffix for consumer grade, meets JESD 201 class 1A whisker test

Polarity: As marked on body

PRIMARY CHARACTERISTICS

$I_{F(AV)}$	1 A
V_{RRM}	50 V to 200 V
I_{FSM}	50 A
I_R	5 μ A
V_F	1.05 V
t_{rr}	50 ns
T_J max.	150 °C

MAXIMUM RATINGS ($T_A = 25$ °C unless otherwise noted)

PARAMETER	SYMBOL	EDF1AM	EDF1BM	EDF1CM	EDF1DM	UNIT
Maximum repetitive peak reverse voltage	V_{RRM}	50	100	150	200	V
Maximum RMS voltage	V_{RMS}	35	70	106	140	V
Maximum DC blocking voltage	V_{DC}	50	100	150	200	V
Max. average forward output rectified current at $T_A = 40$ °C	$I_{F(AV)}$	1.0				A
Peak forward surge current single sine-wave superimposed on rated load	I_{FSM}	50				A
Rating for fusing ($t < 8.3$ ms)	I^2t	10				A ² s
Operating junction and storage temperature range	T_J, T_{STG}	- 55 to + 150				°C

ELECTRICAL CHARACTERISTICS ($T_A = 25$ °C unless otherwise noted)

PARAMETER	TEST CONDITIONS	SYMBOL	EDF1AM	EDF1BM	EDF1CM	EDF1DM	UNIT
Maximum instantaneous forward voltage drop per diode	1.0 A	V_F	1.05				V
Maximum reverse current at rated DC blocking voltage per diode	$T_A = 25$ °C $T_A = 125$ °C	I_R		5.0 1.0			μ A mA
Maximum reverse recovery time per diode	$I_F = 0.5$ A, $I_R = 1.0$ A, $I_{rr} = 0.25$ A	t_{rr}		50			ns



THERMAL CHARACTERISTICS ($T_A = 25\text{ }^\circ\text{C}$ unless otherwise noted)						
PARAMETER	SYMBOL	EDF1AM	EDF1BM	EDF1CM	EDF1DM	UNIT
Typical thermal resistance ⁽¹⁾	$R_{\theta JA}$			38		$^\circ\text{C/W}$
	$R_{\theta JL}$			12		

Note:

(1) Thermal resistance from junction to ambient and from junction to lead mounted on P.C.B. with 0.5 x 0.5" (13 x 13 mm) copper pads

ORDERING INFORMATION (Example)				
PREFERRED P/N	UNIT WEIGHT (g)	PREFERRED PACKAGE CODE	BASE QUANTITY	DELIVERY MODE
EDF1DM-E3/45	0.418	45	50	Tube

RATINGS AND CHARACTERISTICS CURVES

($T_A = 25\text{ }^\circ\text{C}$ unless otherwise noted)

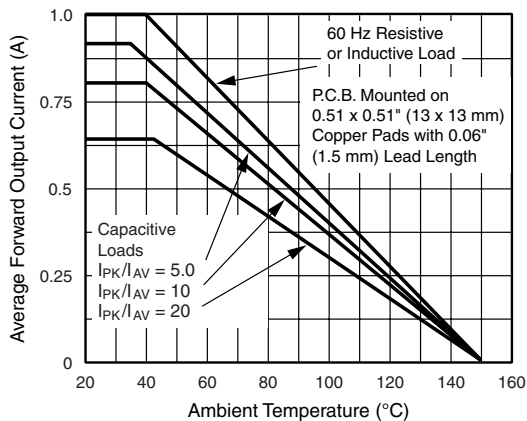

Figure 1. Derating Curves Output Rectified Current

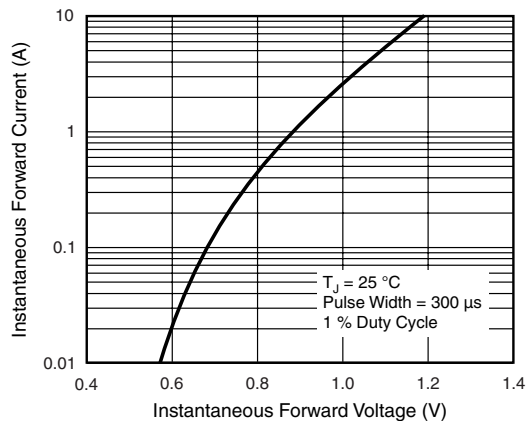

Figure 3. Typical Forward Characteristics Per Diode

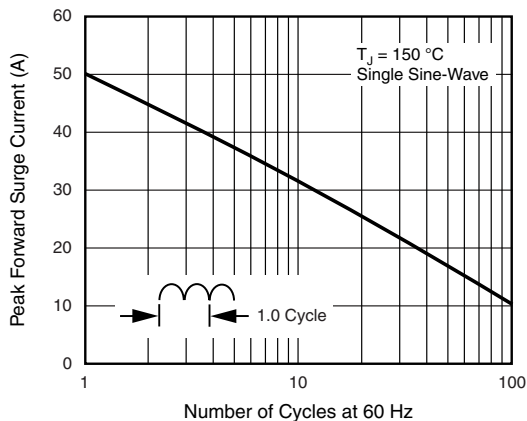

Figure 2. Maximum Non-Repetitive Peak Forward Surge Current Per Diode

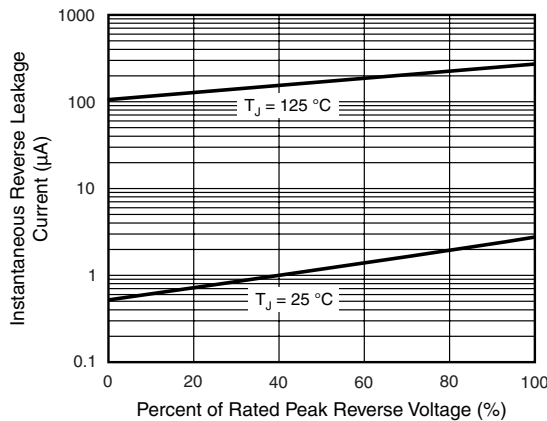

Figure 4. Typical Reverse Leakage Characteristics Per Diode

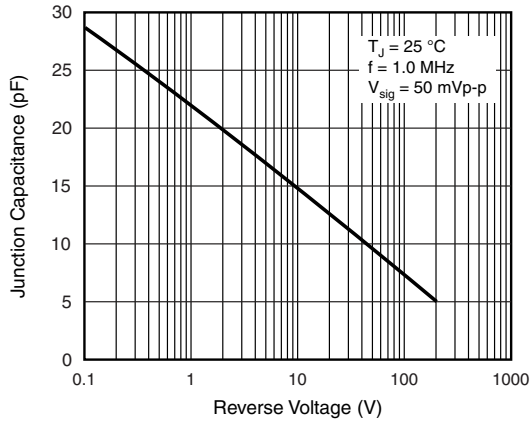
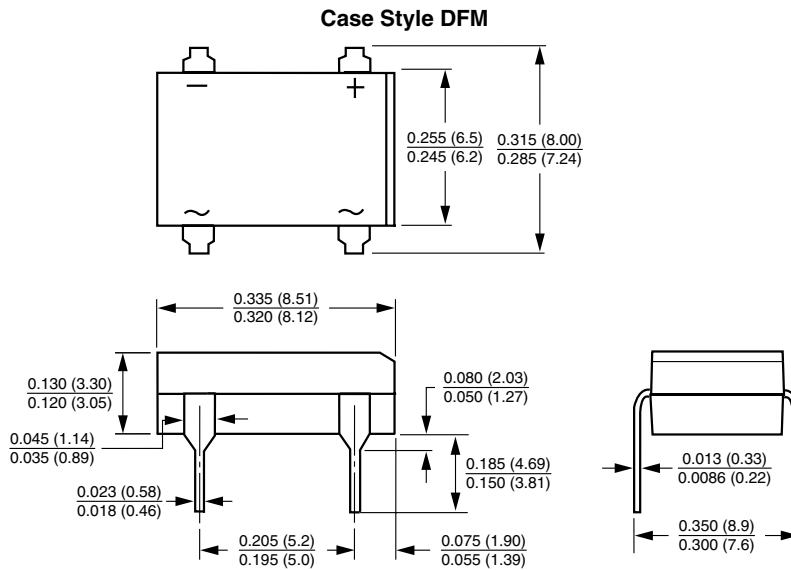

Figure 5. Typical Junction Capacitance Per Diode

PACKAGE OUTLINE DIMENSIONS in inches (millimeters)





Disclaimer

All product specifications and data are subject to change without notice.

Vishay Intertechnology, Inc., its affiliates, agents, and employees, and all persons acting on its or their behalf (collectively, "Vishay"), disclaim any and all liability for any errors, inaccuracies or incompleteness contained herein or in any other disclosure relating to any product.

Vishay disclaims any and all liability arising out of the use or application of any product described herein or of any information provided herein to the maximum extent permitted by law. The product specifications do not expand or otherwise modify Vishay's terms and conditions of purchase, including but not limited to the warranty expressed therein, which apply to these products.

No license, express or implied, by estoppel or otherwise, to any intellectual property rights is granted by this document or by any conduct of Vishay.

The products shown herein are not designed for use in medical, life-saving, or life-sustaining applications unless otherwise expressly indicated. Customers using or selling Vishay products not expressly indicated for use in such applications do so entirely at their own risk and agree to fully indemnify Vishay for any damages arising or resulting from such use or sale. Please contact authorized Vishay personnel to obtain written terms and conditions regarding products designed for such applications.

Product names and markings noted herein may be trademarks of their respective owners.