

# Notice for TAIYO YUDEN products

Please read this notice before using the TAIYO YUDEN products.



## REMINDERS

- Product information in this catalog is as of October 2008. All of the contents specified herein are subject to change without notice due to technical improvements, etc. Therefore, please check for the latest information carefully before practical application or usage of the Products.

Please note that Taiyo Yuden Co., Ltd. shall not be responsible for any defects in products or equipment incorporating such products, which are caused under the conditions other than those specified in this catalog or individual specification.

- Please contact Taiyo Yuden Co., Ltd. for further details of product specifications as the individual specification is available.
- Please conduct validation and verification of products in actual condition of mounting and operating environment before commercial shipment of the equipment.
- All electronic components or functional modules listed in this catalog are developed, designed and intended for use in general electronics equipment.(for AV, office automation, household, office supply, information service, telecommunications, (such as mobile phone or PC) etc.). Before incorporating the components or devices into any equipment in the field such as transportation,( automotive control, train control, ship control), transportation signal, disaster prevention, medical, public information network (telephone exchange, base station) etc. which may have direct influence to harm or injure a human body, please contact Taiyo Yuden Co., Ltd. for more detail in advance.

Do not incorporate the products into any equipment in fields such as aerospace, aviation, nuclear control, submarine system, military, etc. where higher safety and reliability are especially required.

In addition, even electronic components or functional modules that are used for the general electronic equipment, if the equipment or the electric circuit require high safety or reliability function or performances, a sufficient reliability evaluation check for safety shall be performed before commercial shipment and moreover, due consideration to install a protective circuit is strongly recommended at customer's design stage.

- The contents of this catalog are applicable to the products which are purchased from our sales offices or distributors (so called "TAIYO YUDEN' s official sales channel").  
It is only applicable to the products purchased from any of TAIYO YUDEN' s official sales channel.
- Please note that Taiyo Yuden Co., Ltd. shall have no responsibility for any controversies or disputes that may occur in connection with a third party's intellectual property rights and other related rights arising from your usage of products in this catalog. Taiyo Yuden Co., Ltd. grants no license for such rights.
- Caution for export  
Certain items in this catalog may require specific procedures for export according to "Foreign Exchange and Foreign Trade Control Law" of Japan, "U.S. Export Administration Regulations," and other applicable regulations. Should you have any question or inquiry on this matter, please contact our sales staff.  
Should you have any question or inquiry on this matter, please contact our sales staff.

# 角チップビーズインダクタ

## RECTANGULAR FERRITE CHIP BEADS

### (HIGH CURRENT)

### FB SERIES M TYPE

OPERATING TEMP. -40~+85°C



フロー/WAVE

リフロー/REFLOW

### 特長 FEATURES

電源部で使用可能

- ・耐大電流(定格電流6A)
- ・耐高エネルギー
- ・高信頼性

FBMJタイプは様々なバリエーションをラインナップ

- HS: 広帯域対応
- HM: 高帯域対応
- HL: GHz対応

FBMHタイプは、電源ラインのケーブル輻射ノイズ等、高インピーダンス、大電流を要する回路に最適

Power supply units:

- Large withstand voltage (allowable current: up to 6 A)
- Resistance to high energy
- High reliability

There are several variations of the FBMJ type

- HS: For broadband applications
- HM: For upper MHz range applications
- HL: For GHz range applications

The FBMH type are optimal for circuit designs which require high impedances and large currents to combat radiated noise on power lines, etc.

### 用途 APPLICATIONS

- ・電源ラインの輻射・伝導ノイズ対策
- ・各種デジタル機器におけるデジタル信号の波形整形、データラインの高周波ノイズ対策
- ・電装機器
- ・OA機器
- ・USB等の差動伝送ライン
- ・低消費電力化が要求される携帯機器

- ・ Deals with power line radiated and conducted noise.
- ・ Provides waveform correction of digital signals and high frequency noise countermeasures in various types of digital equipment.
- ・ Automotive
- ・ Computer Peripherals
- ・ Differential transmission line on USB and similar products
- ・ Mobile devices which require lower power consumption

### 形名表記法 ORDERING CODE

<b>1</b>	<b>2</b>	<b>3</b>	<b>4</b>	<b>5</b>	<b>6</b>	<b>7</b>	<b>8</b>	<b>9</b>
形式	形状	特性区分	外形寸法 (L×W) [mm]	材質コード	公称インピーダンス [Ω]	インピーダンス許容差	梱包仕様	当社管理記号
FB フェライトビーズインダクタ	M 角形チップ	J 標準品 H 高インピーダンス品	1608 (0603) 1.6×0.8 2125 (0805) 2.0×1.25 2012 (0805) 2.0×1.25 2016 (0806) 2.0×1.6 3216 (1206) 3.2×1.6 3225 (1210) 3.2×2.5 4516 (1806) 4.5×1.6 4525 (1810) 4.5×2.5 4532 (1812) 4.5×3.2	HS 材質によりインピーダンス特性が異なる HM HL	例 330 33 111 110 132 1300	— ± 25% N ± 30%	T テーピング	△ 標準品 △=スペース



<b>1</b>	<b>3</b>	<b>4</b>	<b>5</b>	<b>7</b>
Type	Product characteristics	External Dimensions (L×W) (mm)	Material code	Impedance Tolerance
FB Ferrite bead	J Standard type H High Impedance type	1608 (0603) 1.6×0.8 2125 (0805) 2.0×1.25 2012 (0805) 2.0×1.25 2016 (0806) 2.0×1.6 3216 (1206) 3.2×1.6 3225 (1210) 3.2×2.5 4516 (1806) 4.5×1.6 4525 (1810) 4.5×2.5 4532 (1812) 4.5×3.2	HS Refer to impedance curves for material difference HM HL	— ± 25% N ± 30%
<b>2</b>			<b>6</b>	<b>8</b>
Shape			Nominal Impedance [Ω]	Packaging
M Rectangular chip			example 330 33 111 110 132 1300	T Tape&Reel
				<b>9</b>
				Internal code
				△ Standard product △=Blank space

# 外形寸法 EXTERNAL DIMENSIONS

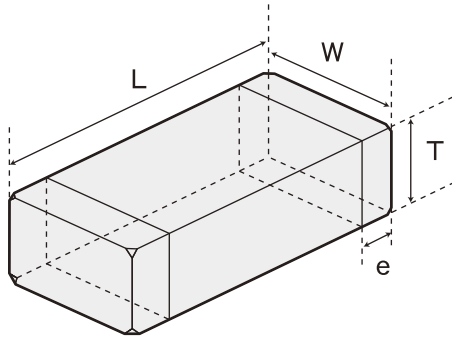

Type	L	W	T	e
FBMJ1608 (0603)	1.6 ± 0.2 (0.063 ± 0.008)	0.8 ± 0.2 (0.031 ± 0.008)	0.8 ± 0.2 (0.031 ± 0.008)	0.3 ± 0.2 (0.012 ± 0.008)
FBMJ2125 (0805)	2.0 ± 0.2 (0.079 ± 0.008)	1.25 ± 0.2 (0.049 ± 0.008)	0.85 ± 0.2 (0.033 ± 0.008)	0.5 ± 0.3 (0.020 ± 0.012)
FBMJ3216 (1206)	3.2 ± 0.3 (0.126 ± 0.012)	1.6 ± 0.2 (0.063 ± 0.008)	1.1 ± 0.2 (0.043 ± 0.008)	0.5 ± 0.3 (0.020 ± 0.012)
FBMJ4516 (1806)	4.5 ± 0.3 (0.177 ± 0.012)	1.6 ± 0.2 (0.063 ± 0.008)	1.1 ± 0.2 (0.043 ± 0.008)	0.5 ± 0.3 (0.020 ± 0.012)
FBMH1608 (0603)	1.6 ± 0.1 (0.063 ± 0.004)	0.8 ± 0.1 (0.031 ± 0.004)	0.8 ± 0.1 (0.031 ± 0.004)	0.3 ± 0.15 (0.012 ± 0.006)
FBMH2012 (0805)	2.0 ± 0.2 (0.079 ± 0.008)	1.25 ± 0.2 (0.049 ± 0.008)	0.85 ± 0.2 (0.033 ± 0.008)	0.5 ± 0.3 (0.020 ± 0.012)
FBMH2016 (0806)	2.0 ± 0.2 (0.079 ± 0.008)	1.6 ± 0.2 (0.063 ± 0.008)	1.6 ± 0.2 (0.063 ± 0.008)	0.5 ± 0.3 (0.020 ± 0.012)
FBMH3216 (1206)	3.2 ± 0.3 (0.126 ± 0.012)	1.6 ± 0.2 (0.063 ± 0.008)	1.6 ± 0.2 (0.063 ± 0.008)	0.5 ± 0.3 (0.020 ± 0.012)
FBMH3225 (1210)	3.2 ± 0.3 (0.126 ± 0.012)	2.5 ± 0.3 (0.098 ± 0.012)	2.5 ± 0.3 (0.098 ± 0.012)	0.5 ± 0.3 (0.020 ± 0.012)
FBMH4516 (1806)	4.5 ± 0.3 (0.177 ± 0.012)	1.6 ± 0.2 (0.063 ± 0.008)	1.6 ± 0.2 (0.063 ± 0.008)	0.5 ± 0.3 (0.020 ± 0.012)
FBMH4525 (1810)	4.5 ± 0.4 (0.177 ± 0.016)	2.5 ± 0.3 (0.098 ± 0.012)	2.5 ± 0.3 (0.098 ± 0.012)	0.9 ± 0.6 (0.035 ± 0.024)
FBMH4532 (1812)	4.5 ± 0.4 (0.177 ± 0.016)	3.2 ± 0.3 (0.126 ± 0.012)	3.2 ± 0.3 (0.126 ± 0.012)	0.9 ± 0.6 (0.035 ± 0.024)

## 推奨ランドパターン Recommended Land Pattern Dimensions

Unit : mm (inch)

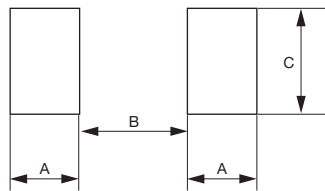

形名 Parts Number	寸法 Dimensions (mm)			形名 Parts Number	寸法 Dimensions (mm)		
	A	B	C		A	B	C
FB MJ1608タイプ (type)	1.0	1.0	1.0	FB MH2016タイプ (type)	1.4	1.2	2.0
FB MJ2125タイプ (type)	1.4	1.2	1.65	FB MH3216タイプ (type)	1.4	2.2	2.0
FB MJ3216タイプ (type)	1.4	2.2	2.0	FB MH4516タイプ (type)	1.75	3.5	2.0
FB MJ4516タイプ (type)	1.75	3.5	2.0	FB MH3225タイプ (type)	1.4	2.2	2.9
FB MH1608タイプ (type)	1.0	1.0	1.0	FB MH4525タイプ (type)	1.75	3.5	2.9
FB MH2012タイプ (type)	1.4	1.2	1.65	FB MH4532タイプ (type)	1.75	3.5	3.7

# 概略バリエーション AVAILABLE MATERIALS

## 標準品 (Standard Type)

FBMJ1608

HS-type

I max=4A

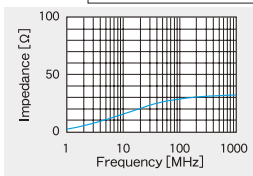

HM-type

I max=4A

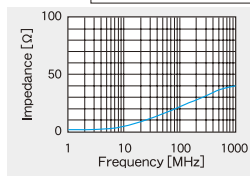

## 高インピーダンス品 (High impedance Type)

FBMJ1608

HM-type

I max=0.3~3.5A

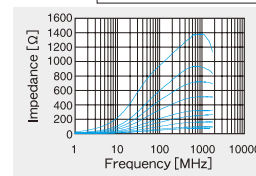

HL-type

I max=0.3~2.5A

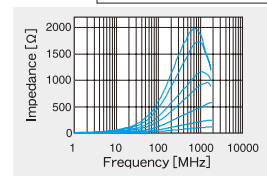

FBMJ2125

HS-type

I max=4~6A

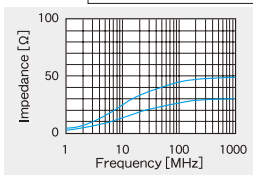

HM-type

I max=4~6A

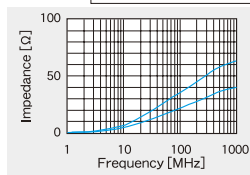

HL-type

I max=2A

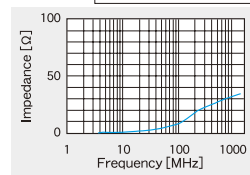

FBMH2016

I max=1.8~2.7A

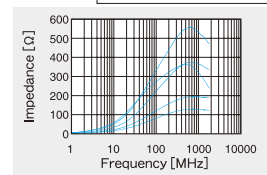

FBMJ3216

HS-type

I max=4~6A

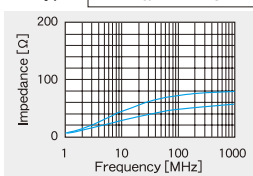

HM-type

I max=4~6A

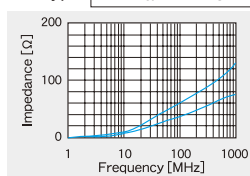

FBMH3216

I max=1~3A

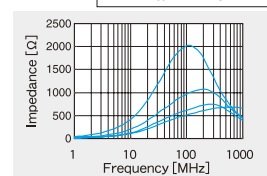

FBMJ4516

HS-type

I max=4~6A

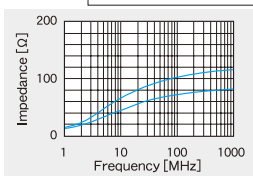

HM-type

I max=4~6A

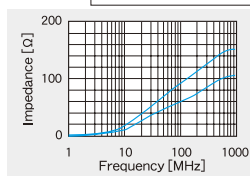

FBMH4516

I max=1.5~4A

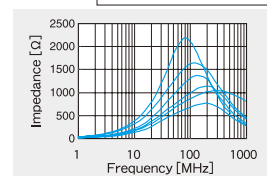

セレクションガイド  
Selection Guide

アイテム一覧  
Part Numbers

特性図  
Electrical Characteristics

梱包  
Packaging

信頼性  
Reliability Data

使用上の注意  
Precautions



etc

## アイテム一覧 PART NUMBERS

標準品 (Standard Type)

FBMJ1608

形名 Ordering code	EHS (Environmental Hazardous Substances)	インピーダンス Impedance 〔Ω〕	インピーダンス 測定周波数 Measuring frequency 〔MHz〕	直流抵抗 DC Resistance 〔Ω〕max.	定格電流 Rated current 〔A〕max.	厚み Thickness 〔mm〕 〔inch〕
FB MJ1608HS280NT	RoHS	28±30%	100	0.007	4.0	0.8±0.2 (0.031±0.008)
FB MJ1608HM230NT	RoHS	23±30%				

FBMJ2125

形名 Ordering code	EHS (Environmental Hazardous Substances)	インピーダンス Impedance 〔Ω〕	インピーダンス 測定周波数 Measuring frequency 〔MHz〕	直流抵抗 DC Resistance 〔Ω〕max.	定格電流 Rated current 〔A〕max.	厚み Thickness 〔mm〕 〔inch〕
FB MJ2125HS420-T	RoHS	42 ± 25%	100	0.008	4.0	0.85 ± 0.2 (0.033 ± 0.008)
FB MJ2125HS250NT	RoHS	25 ± 30%		0.004	6.0	
FB MJ2125HM330-T	RoHS	33 ± 25%		0.008	4.0	
FB MJ2125HM210NT	RoHS	21 ± 30%		0.004	6.0	
FB MJ2125HL8R0NT	RoHS	8 ± 30%		0.010	2.0	

FBMJ3216

形名 Ordering code	EHS (Environmental Hazardous Substances)	インピーダンス Impedance 〔Ω〕	インピーダンス 測定周波数 Measuring frequency 〔MHz〕	直流抵抗 DC Resistance 〔Ω〕max.	定格電流 Rated current 〔A〕max.	厚み Thickness 〔mm〕 〔inch〕
FB MJ3216HS800-T	RoHS	80±25%	100	0.010	4.0	1.1±0.2 (0.043±0.008)
FB MJ3216HS480NT	RoHS	48±30%		0.005	6.0	
FB MJ3216HM600-T	RoHS	60±25%		0.010	4.0	
FB MJ3216HM380NT	RoHS	38±30%		0.005	6.0	

FBMJ4516

形名 Ordering code	EHS (Environmental Hazardous Substances)	インピーダンス Impedance 〔Ω〕	インピーダンス 測定周波数 Measuring frequency 〔MHz〕	直流抵抗 DC Resistance 〔Ω〕max.	定格電流 Rated current 〔A〕max.	厚み Thickness 〔mm〕 〔inch〕
FB MJ4516HS111-T	RoHS	110±25%	100	0.014	4.0	1.1±0.2 (0.043±0.008)
FB MJ4516HS720NT	RoHS	72±30%		0.007	6.0	
FB MJ4516HM900-T	RoHS	90±25%		0.014	4.0	
FB MJ4516HM560NT	RoHS	56±30%		0.007	6.0	

高インピーダンス品 (High impedance Type)

形名 Ordering code	EHS (Environmental Hazardous Substances)	インピーダンス Impedance [Ω]	インピーダンス 測定周波数 Measuring frequency [MHz]	直流抵抗 DC Resistance [Ω] max.	定格電流 Rated current [A] max.	厚み Thickness [mm] (inch)
FB MH1608HM470-T	RoHS	47±25%	100	0.020	3.5	0.8±0.1 (0.031±0.004)
FB MH1608HM600-T	RoHS	60±25%		0.025	3.0	
FB MH1608HM101-T	RoHS	100±25%		0.035	2.0	
FB MH1608HM151-T	RoHS	150±25%		0.050	2.0	
FB MH1608HM221-T	RoHS	220±25%		0.070	1.5	
FB MH1608HM331-T	RoHS	330±25%		0.130	0.9	
FB MH1608HM471-T	RoHS	470±25%		0.150	0.7	
FB MH1608HM601-T	RoHS	600±25%		0.170	0.7	
FB MH1608HM102-T	RoHS	1000±25%		0.350	0.5	
FB MH1608HL300-T	RoHS	30±25%		0.028	2.5	
FB MH1608HL600-T	RoHS	60±25%		0.045	1.8	
FB MH1608HL121-T	RoHS	120±25%		0.130	0.9	
FB MH1608HL221-T	RoHS	220±25%		0.170	0.7	
FB MH1608HL331-T	RoHS	330±25%		0.210	0.6	
FB MH1608HL471-T	RoHS	470±25%		0.350	0.5	
FB MH1608HL601-T	RoHS	600±25%		0.450	0.4	
FB MH2012HM800-T	RoHS	80±25%		0.025	2.7	0.85±0.2 (0.033±0.008)
FB MH2012HM121-T	RoHS	120±25%		0.032	2.5	
FB MH2012HM221-T	RoHS	220±25%		0.060	2.0	
FB MH2012HM331-T	RoHS	330±25%		0.080	1.8	1.6±0.2 (0.063±0.008)
FB MH2016HM251NT	RoHS	250±30%		0.050	2.0	
FB MH3216HM501NT	RoHS	500±30%		0.070	2.0	2.5±0.3 (0.098±0.012)
FB MH4516HM851NT	RoHS	850±30%		0.100	1.5	
FB MH3225HM601NT	RoHS	600±30%		0.042	3.0	
FB MH3225HM102NT	RoHS	1000±30%		0.100	2.0	
FB MH3225HM202NT	RoHS	2000±30%		0.130	1.2	3.2±0.3 (0.126±0.012)
FB MH4525HM102NT	RoHS	1000±30%		0.060	3.0	
FB MH4525HM162NT	RoHS	1600±30%		0.130	2.0	
FB MH4532HM681-T	RoHS	680±25%	0.028	4.0		
FB MH4532HM132-T	RoHS	1300±25%	0.060	3.0		
FB MH4532HM202-T	RoHS	2000±25%	0.130	1.3		

標準品 (Standard Type)

FBMJ1608

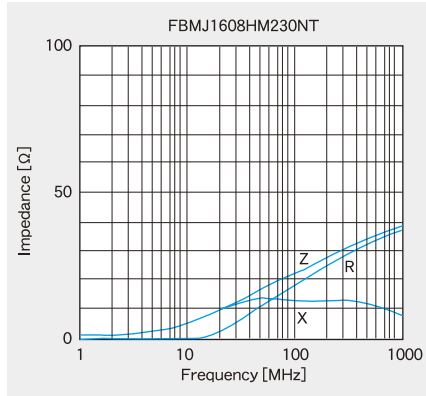
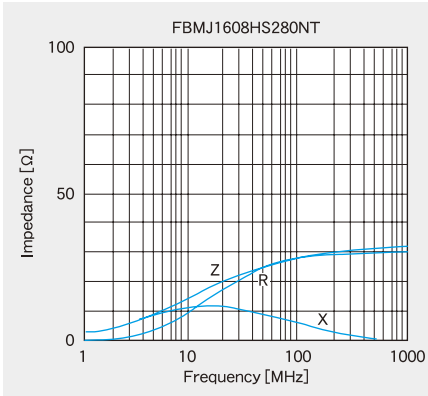

FBMJ2125

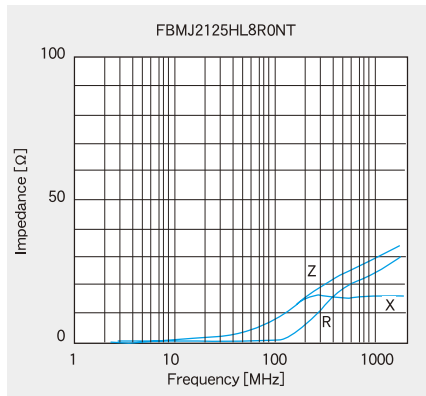
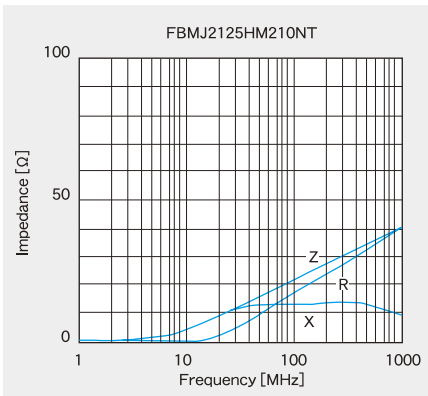
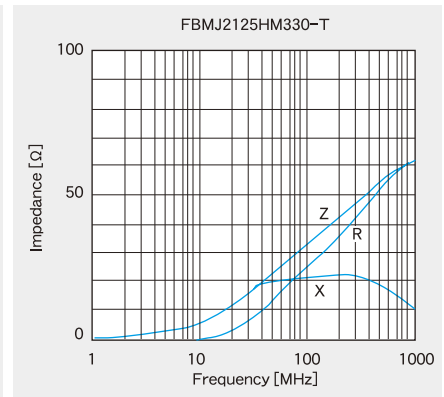
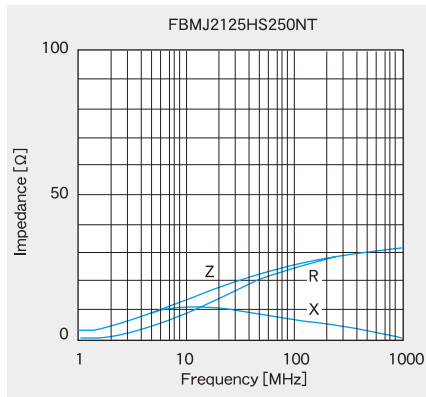
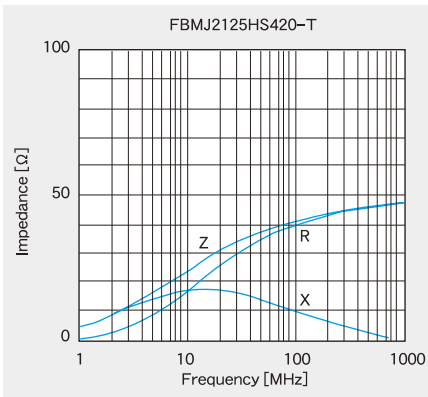

FBMJ3216

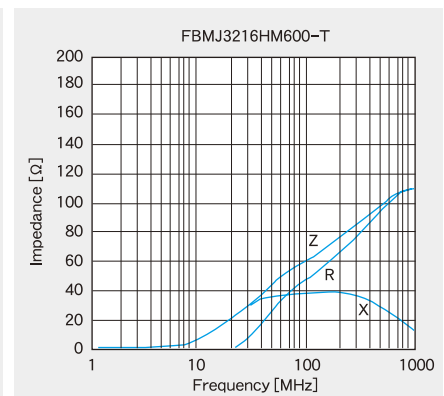
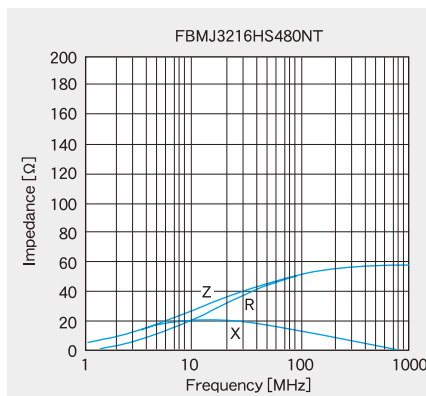
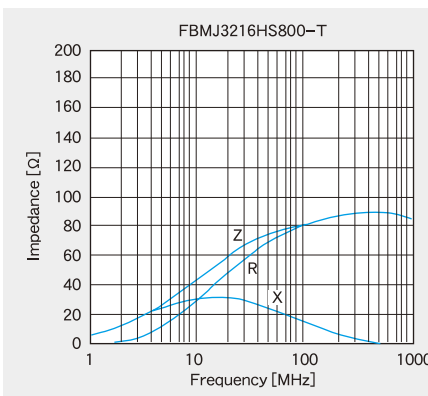

標準品 (Standard Type)

FBMJ3216

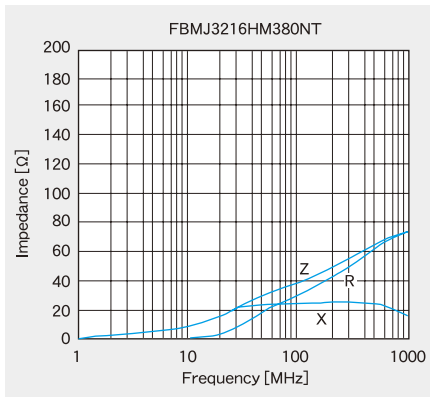

FBMJ4516

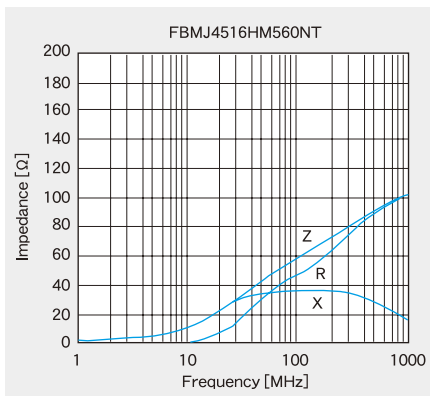
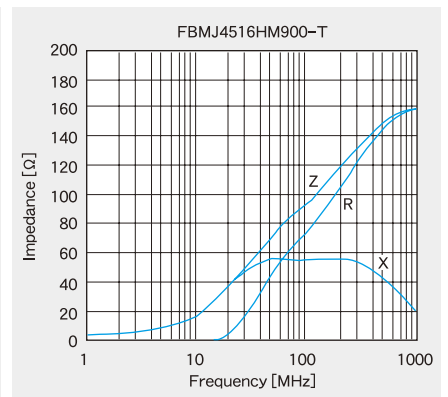
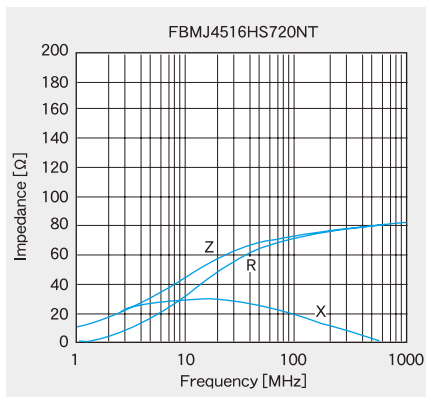
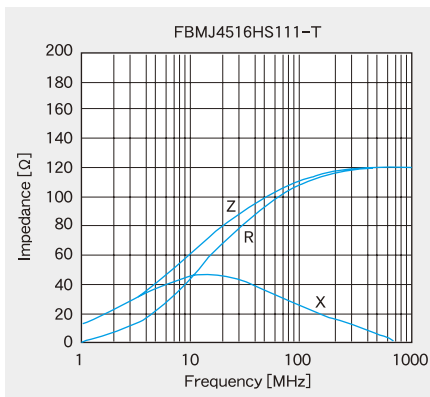

高インピーダンス品 (High impedance Type)

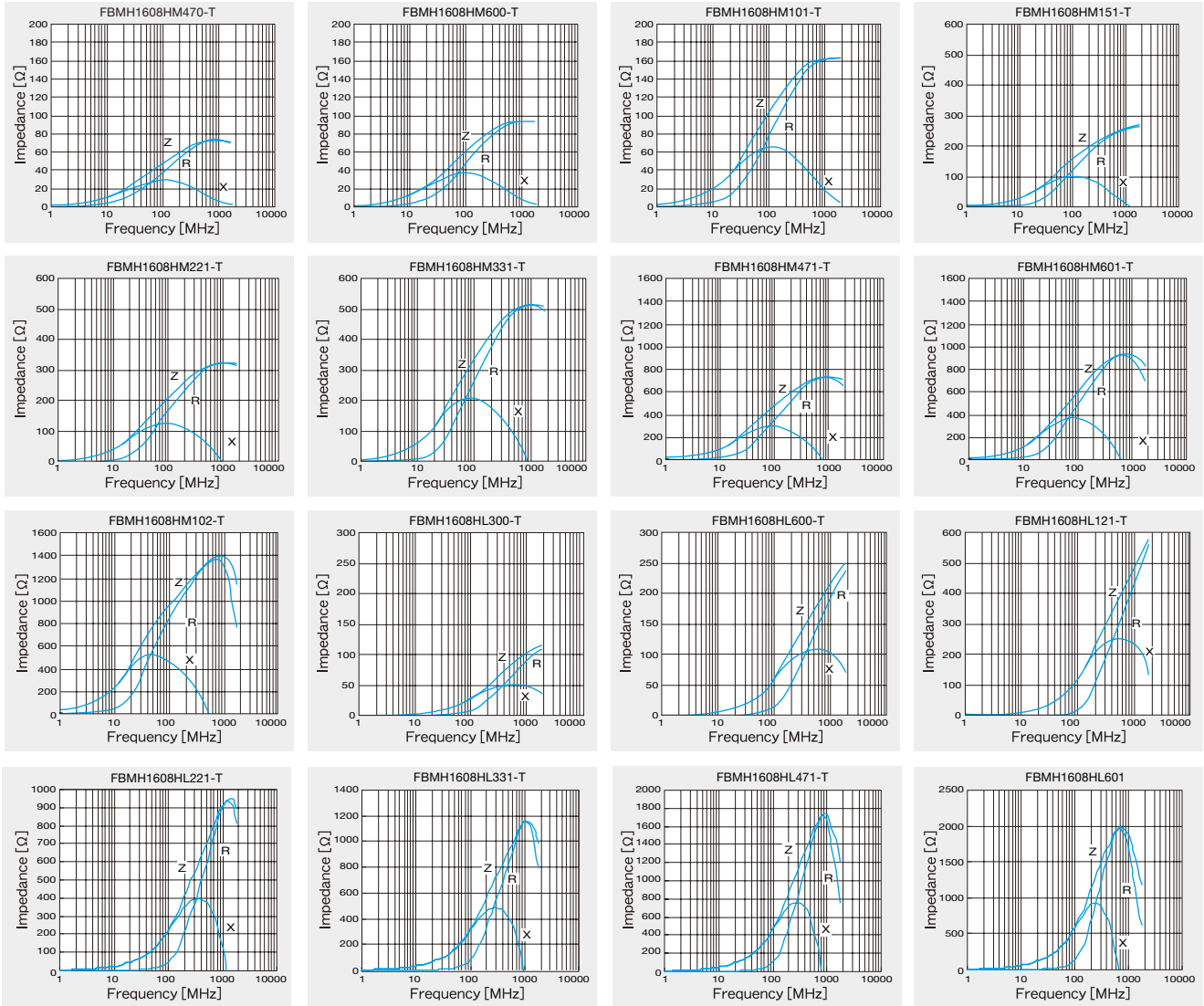



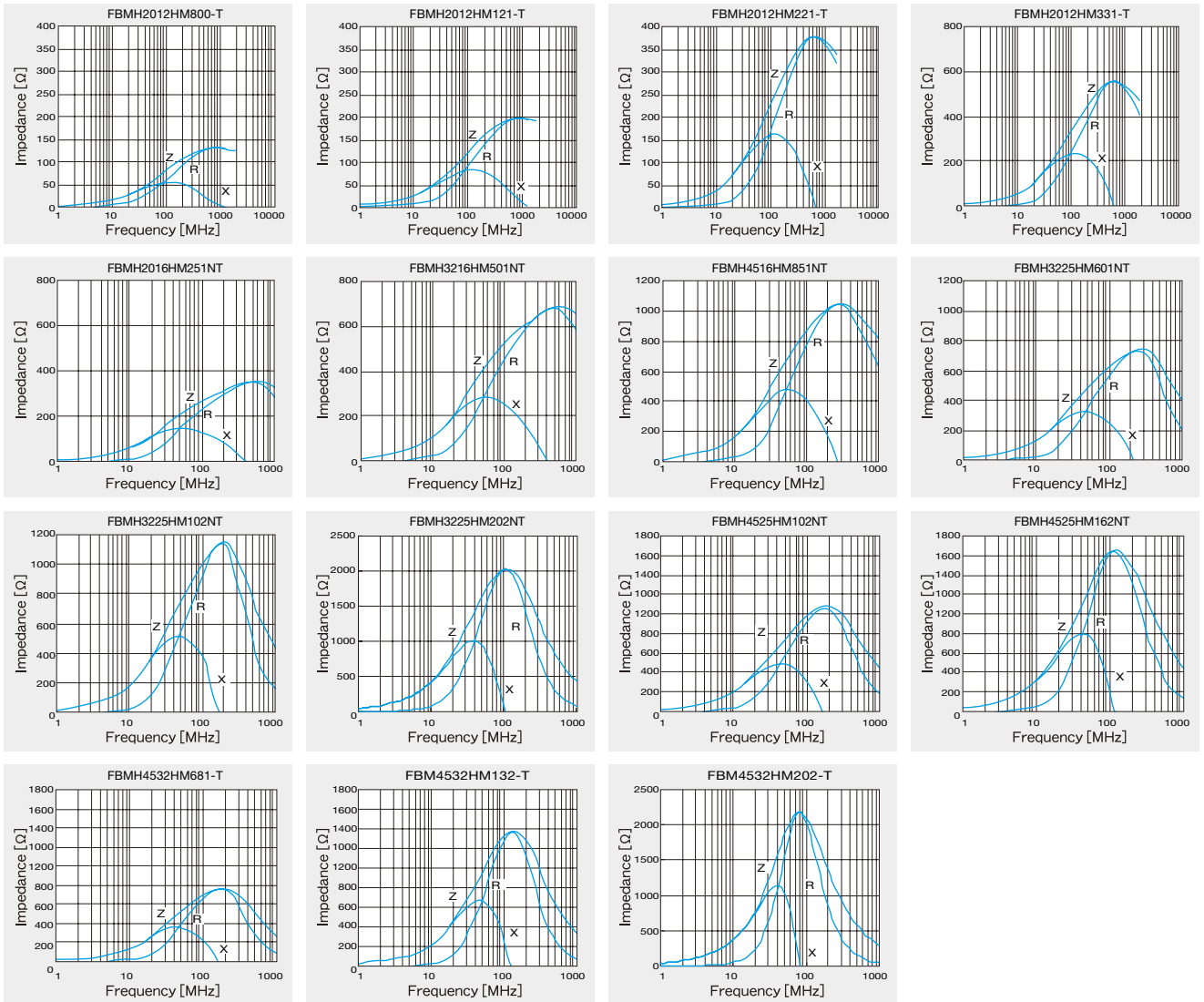

①最小受注単位数 Minimum Quantity

Type	標準数量 Standard Quantity [pcs]	
	紙テーピング Paper Tape	エンボステーピング Embossed Tape
1608 (0603)	4000	—
2125 (0805)	4000	—
2012 (0805)	4000	—
2016 (0806)	—	2000
3216 (1206)	—	2000
4516 (1806)	—	2000
3225 (1210)	—	1000
4525 (1810)	—	1000
4532 (1812)	—	2000

②テーピング材質 Tape Material

紙テープ  
Card board carrier tape

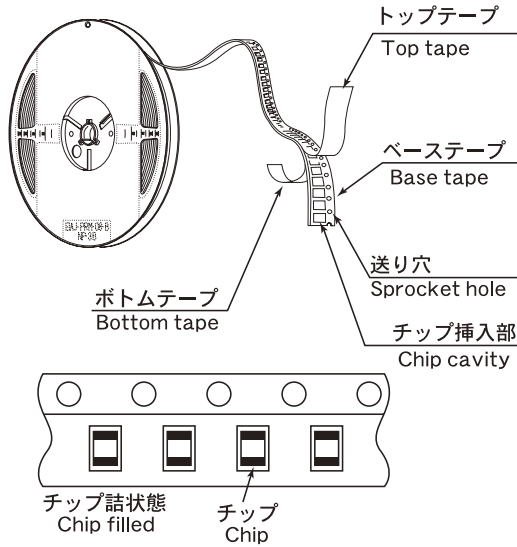

エンボステーブ  
Embossed Tape

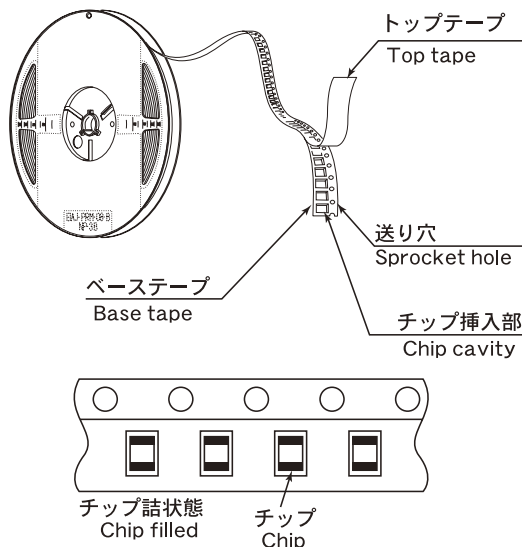

③テープ寸法 Taping Dimensions

紙テープ (8mm幅) Paper tape (0.315 inches wide)

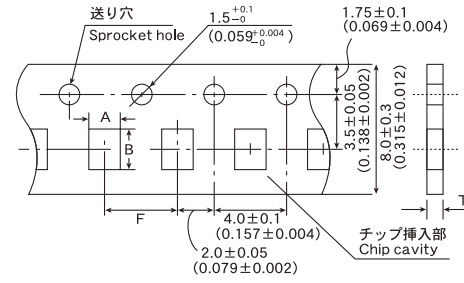

形式 Type	チップ挿入部 Chip Cavity		挿入ピッチ Insertion Pitch	テープ厚み Tape Thickness
	A	B	F	T
FBMJ1608 FBMH1608 (0603)	1.0 $\pm$ 0.2 (0.039 $\pm$ 0.008)	1.8 $\pm$ 0.2 (0.071 $\pm$ 0.008)	4.0 $\pm$ 0.2 (0.157 $\pm$ 0.008)	1.1max (0.043max)
FBMJ2125 FBMH2012 (0805)	1.5 $\pm$ 0.2 (0.059 $\pm$ 0.008)	2.3 $\pm$ 0.2 (0.091 $\pm$ 0.008)	4.0 $\pm$ 0.2 (0.157 $\pm$ 0.008)	1.1max (0.043max)

Unit : mm (inch)

エンボステーブ (8mm幅) Embossed tape (0.315 inches wide)

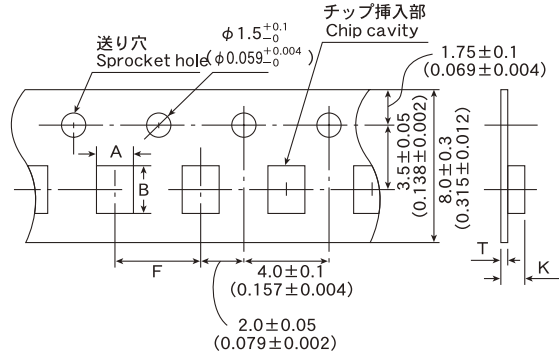

形式 Type	チップ挿入部 Chip Cavity		挿入ピッチ Insertion Pitch	テープ厚み Tape Thickness	
	A	B	F	K	T
FBMH2016 (0806)	1.8 $\pm$ 0.2 (0.071 $\pm$ 0.008)	2.2 $\pm$ 0.2 (0.087 $\pm$ 0.008)	4.0 $\pm$ 0.2 (0.157 $\pm$ 0.008)	2.6max (0.102max)	0.6max (0.024max)
FBMJ3216 (1206)	1.9 $\pm$ 0.2 (0.075 $\pm$ 0.008)	3.5 $\pm$ 0.2 (0.138 $\pm$ 0.008)	4.0 $\pm$ 0.2 (0.157 $\pm$ 0.008)	1.5max (0.059max)	0.3max (0.012max)
FBMH3216 (1206)	1.9 $\pm$ 0.2 (0.075 $\pm$ 0.008)	3.5 $\pm$ 0.2 (0.138 $\pm$ 0.008)	4.0 $\pm$ 0.2 (0.157 $\pm$ 0.008)	2.6max (0.102max)	0.6max (0.024max)
FBMH3225 (1210)	2.8 $\pm$ 0.2 (0.110 $\pm$ 0.008)	3.5 $\pm$ 0.2 (0.138 $\pm$ 0.008)	4.0 $\pm$ 0.2 (0.157 $\pm$ 0.008)	4.0max (0.157max)	0.6max (0.024max)

Unit : mm (inch)

エンボステープ (12mm幅) Embossed tape (0.472 inches wide)

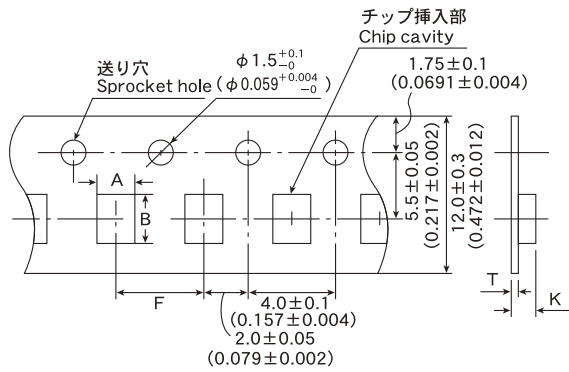

⑤リール寸法 Reel size

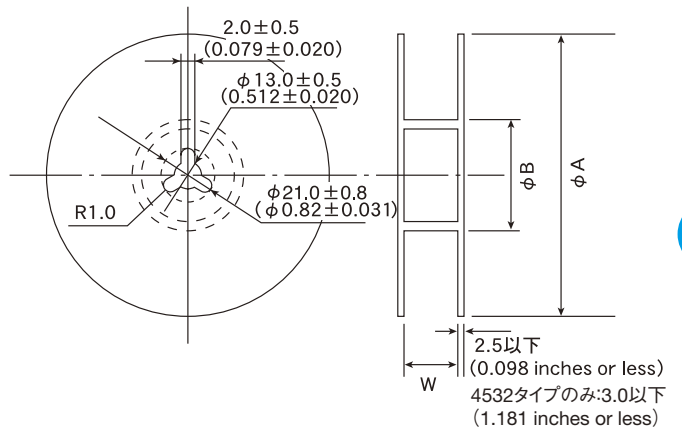

形式 Type	チップ挿入部 Chip cavity		挿入ピッチ Insertion pitch	テープ厚み Tape Thickness	
	A	B		K	T
FBMJ4516 (1806)	1.9 ± 0.2 (0.075 ± 0.008)	4.9 ± 0.2 (0.193 ± 0.008)	4.0 ± 0.2 (0.157 ± 0.008)	1.5max (0.059max)	0.3max (0.012max)
FBMH4516 (1806)	1.9 ± 0.2 (0.075 ± 0.008)	4.9 ± 0.2 (0.193 ± 0.008)	4.0 ± 0.2 (0.157 ± 0.008)	2.6max (0.102max)	0.6max (0.024max)
FBMH4525 (1810)	2.9 ± 0.2 (0.114 ± 0.008)	4.9 ± 0.2 (0.193 ± 0.008)	4.0 ± 0.2 (0.157 ± 0.008)	4.0max (0.157max)	0.6max (0.024max)
FBMH4532 (1812)	3.6 ± 0.2 (0.142 ± 0.008)	4.9 ± 0.2 (0.193 ± 0.008)	8.0 ± 0.2 (0.315 ± 0.008)	4.0max (0.157max)	0.6max (0.024max)

Unit : mm (inch)

形式 Type	$\phi A$ (mm) (inch)	$\phi B$ (mm) (inch)	W (mm) (inch)
FBMJ1608	180 $^{+0}_-3$ (7.09 $^{+0}_-0.118$ )	60 $^{+1}_-0$ (2.36 $^{+0.039}_-0$ )	10.0 ± 1.5 (0.394 ± 0.047)
FBMJ2125			14.0 ± 1.5 (0.551 ± 0.059)
FBMJ3216			
FBMJ4516			10.0 ± 1.5 (0.394 ± 0.047)
FBMH1608			
FBMH2012			
FBMH2016			
FBMH3216			
FBMH3225			
FBMH4516			14.0 ± 1.5 (0.551 ± 0.059)
FBMH4525			
FBMH4532	330 ± 2.0 (12.99 ± 0.080)	100 ± 1.0 (3.94 ± 0.039)	14 ± 2.0 (0.551 ± 0.080)

④リーダー部・空部 Leader and Blank portion

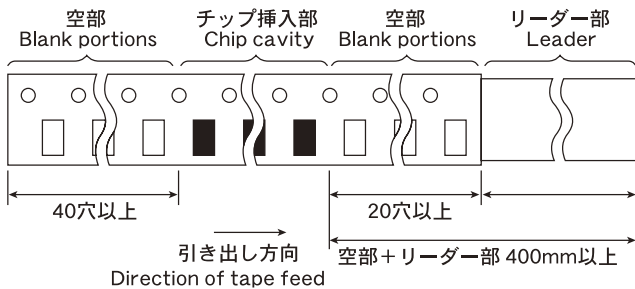

Insertion leader is 400 mm or more (including 20 empty cavities)  
Empty cavities at end of reel: 40 holes or more

⑥トップテープ強度 Top tape strength

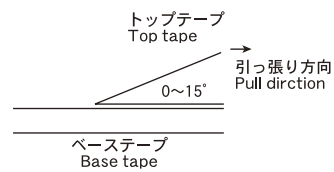

トップテープのはがし力は、下図矢印方向にて0.1~0.7Nとなります。  
The top tape requires a peel-off force of 0.1 to 0.7N in the direction of the arrow as illustrated below.

RECTANGULAR FERRITE CHIP BEADS (HIGH CURRENT) FB series M type

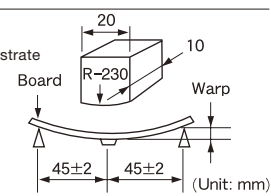
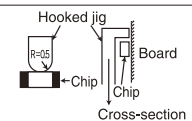
Item	Specified Value	Test Methods and Remarks															
1. Operating Temperature Range	-40~+85°C																
2. Storage Temperature Range	-40~+85°C	*Note: 0 to +40°C in taped packaging															
3. Impedance	Within the specified tolerance	Measuring equipment: Impedance analyzer (HP4291A) or its equivalent Measuring frequency: 100±1 MHz															
4. DC Resistance	Within the specified range	Four-terminal method Measuring equipment: Milliohm High-Tester 3226(Hioki Denki) or its equivalent															
5. Rated Current	Within the specified range																
6. Vibration	Appearance: No significant abnormality Impedance change: Within ±30% of the initial value	According to JIS C 0040. Vibration type: A Directions: 2 hrs each in X,Y, and Z directions Total: 6 hrs Frequency range: 10 to 55 to 10Hz(/min.) Amplitude: 1.5 mm (shall not exceed acceleration 196m/s <sup>2</sup> ) Mounting method: Soldering onto PC board															
7. Solderability	75% or more of immersed surface of terminal electrode shall be covered with fresh solder.	Solder temperature: 230±5°C Duration: 4±1 sec. Preconditioning: Immersion into flux. Immersion and Removal speed: 25mm/sec.															
8. Resistance to Solder Heat	Appearance: No significant abnormality Impedance change: Within ±30% of the initial value	Preheating: 150°C for 3 min. Solder temperature: 260±5°C Duration: 10±0.5sec Preconditioning: Immersion into flux. Immersion and Removal speed: 25 mm/sec. Recovery: 2 to 3 hrs of recovery under the standard condition after the test.															
9. Thermal Shock	Appearance: No significant abnormality Impedance change: Within $\begin{matrix} +50 \\ -10 \end{matrix}$ % of the initial value	According to JIS C 0025. Conditions for 1 cycle <table border="1"> <thead> <tr> <th>Step</th> <th>Temperature (°C)</th> <th>Duration (min.)</th> </tr> </thead> <tbody> <tr> <td>1</td> <td>-40±3°C</td> <td>30±3</td> </tr> <tr> <td>2</td> <td>Room Temperature</td> <td>Within 3</td> </tr> <tr> <td>3</td> <td>85±2°C</td> <td>30±3</td> </tr> <tr> <td>4</td> <td>Room Temperature</td> <td>Within 3</td> </tr> </tbody> </table> Number of cycles: 100 Mounting method: Soldering onto PC board Recovery: 2 to 3 hrs of recovery under the standard condition after the removal from test chamber.	Step	Temperature (°C)	Duration (min.)	1	-40±3°C	30±3	2	Room Temperature	Within 3	3	85±2°C	30±3	4	Room Temperature	Within 3
Step	Temperature (°C)	Duration (min.)															
1	-40±3°C	30±3															
2	Room Temperature	Within 3															
3	85±2°C	30±3															
4	Room Temperature	Within 3															
10. Humidity (steady state)	Appearances: No significant abnormality Impedance change: Within ±30% of the initial value	Temperature: 40±2°C Humidity: 90 to 95%RH Duration: 500 $\begin{matrix} +24 \\ -0 \end{matrix}$ hrs Mounting method: Soldering onto PC board Recovery: 2 to 3 hrs of recovery under the standard condition after the removal from test chamber.															
11. Loading under Damp Heat	Appearance : No significant abnormality Impedance change : Within ±30% of the initial value	Temperature : 40±2°C Humidity : 90 to 95%RH Applied current : Rated current Duration : 500 $\begin{matrix} +24 \\ -0 \end{matrix}$ hrs Mounting method : Soldering onto PC board Recovery : 2 to 3hrs of recovery under the standard condition after the removal from test chamber.															
12. High Temperature Loading Test	Appearance: No significant abnormality Impedance change: Within ±30% of the initial value	Temperature: 85±2°C Duration: 500 $\begin{matrix} +24 \\ -0 \end{matrix}$ hrs Applied current: Rated current Mounting method: Soldering onto PC board Recovery: 2 to 3 hrs of recovery under the standard condition after the removal from test chamber.															
13. Resistance to Flexure of Substrate	No mechanical damage.	Warp: 2mm Testing board: Glass epoxy-resin substrate Thickness: 0.8mm 															
14. Adhesion of Electrode	No separation or indication of separation of electrode.	Applied force: 5N Duration: 10 sec. 															

Note on standard condition: "standard condition" referred to herein is defined as follows 5 to 35°C of temperature, 45 to 85% relative humidity and 86 to 106kPa of air pressure.  
When there are questions concerning measurement results: In order to provide correlation data, the test shall be conducted under condition of 20±2°C of temperature, 60 to 70% relative humidity and 86 to 106kPa of air pressure.  
Unless otherwise specified, all the tests are conducted under the "standard condition."

FBM Type

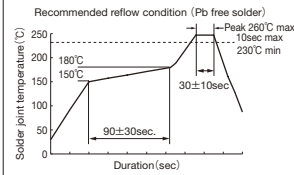
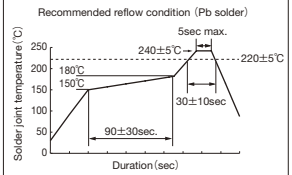
Stages	Precautions	Technical considerations
1.Circuit Design	<p>Operating environment,</p> <p>1.The products described in this specification are intended for use in general electronic equipment,(office supply equipment, telecommunications systems, measuring equipment, and household equipment). They are not intended for use in mission-critical equipment or systems requiring special quality and high reliability (traffic systems, safety equipment, aerospace systems, nuclear control systems and medical equipment including life-support systems,) where product failure might result in loss of life, injury or damage. For such uses, contact TAIYO YUDEN Sales Department in advance.</p> <p>Rated current</p> <p>1.Rated current of this product is shown in this catalogue, but please be sure to have the base board designed with adequate inspection in case of the generation of heat becomes high within the rated current range when the base board is in high resistance or in bad heating conditions.</p>	
2.PCB Design	<p>Land pattern design</p> <p>1.Please refer to a recommended land pattern.</p>	
3.Considerations for automatic placement	<p>Adjustment of mounting machine</p> <p>1.Excessive impact load should not be imposed on the products when mounting onto the PC boards.</p> <p>2.Mounting and soldering conditions should be checked beforehand.</p>	<p>1.When installing products, care should be taken not to apply distortion stress as it may deform the products.</p>
4.Soldering	<p>Wave soldering</p> <p>1.Please refer to the specifications in the catalog for a wave soldering.</p> <p>Reflow soldering</p> <p>1.Please contact any of our offices for a reflow soldering, and refer to the recommended condition specified.</p> <p>Lead free soldering</p> <p>1.When using products with lead free soldering, we request to use them after confirming of adhesion, temperature of resistance to soldering heat, etc. sufficiently.</p> <p>Preheating when soldering</p> <p>Heating:The temperature difference between soldering and remaining heat should not be greater than 150°C.</p> <p>Cooling:The temperature difference between the components and cleaning process should not be greater than 100°C.</p> <p>Recommended conditions for using a soldering iron</p> <p>Put the soldering iron on the land-pattern.</p> <p>Soldering iron's temperature - Below 350°C</p> <p>Duration - 3 seconds or less</p> <p>The soldering iron should not directly touch the inductor.</p>	<p>1.If products are used beyond the range of the recommended conditions, heat stresses may deform the products, and consequently degrade the reliability of the products.</p> <div style="display: flex; justify-content: space-around;">   </div> <p>1.There is a case that products get damaged by a heat shock.</p> <p>1.If products are used beyond the range of the recommended conditions, heat stresses may deform the products, and consequently degrade the reliability of the products.</p>

FBM Type

Stages	Precautions	Technical considerations
5.Handling	<p>Handling</p> <p>1.Keep the inductors away from all magnets and magnetic objects.</p> <p>Setting PC boards</p> <p>1.When setting a chip mounted base board, please make sure that there is no residual stress to the chip by distortion in the board or at screw part.</p> <p>Breakaway PC boards (splitting along perforations)</p> <p>1.When splitting the PC board after mounting inductors, care should be taken not to give any stresses of deflection or twisting to the board.</p> <p>2.Board separation should not be done manually, but by using the appropriate devices.</p> <p>Mechanical considerations</p> <p>1.Please do not give the inductors any excessive mechanical shocks.</p>	<p>1.There is a case that a characteristic varies with magnetic influence.</p> <p>1.There is a case that a characteristic varies with residual stress.</p> <p>1.Planning pattern configurations and the position of products should be carefully performed to minimize stress.</p> <p>1.There is a case to be damaged by a mechanical shock.</p>
6.Storage conditions	<p>Storage</p> <p>1.To maintain the solderability of terminal electrodes and to keep the packing material in good condition, temperature and humidity in the storage area should be controlled..</p> <p>·Recommended conditions</p> <p>Ambient temperature      0~40°C</p> <p>Humidity                      Below 70% RH</p> <p>The ambient temperature must be kept below 30°C. Even under ideal storage conditions, solderability of products electrodes may decrease as time passes. For this reason, inductors should be used within 6 months from the time of delivery.</p>	<p>1. Under a high temperature and humidity environment, problems such as reduced solderability caused by oxidation of terminal electrodes and deterioration of taping/package materials may take place.</p>