

# Type FCA Acrylic Surface Mount Film Capacitors

## Acrylic Stacked Metallized Film Capacitors for Filtering and Noise Attenuation

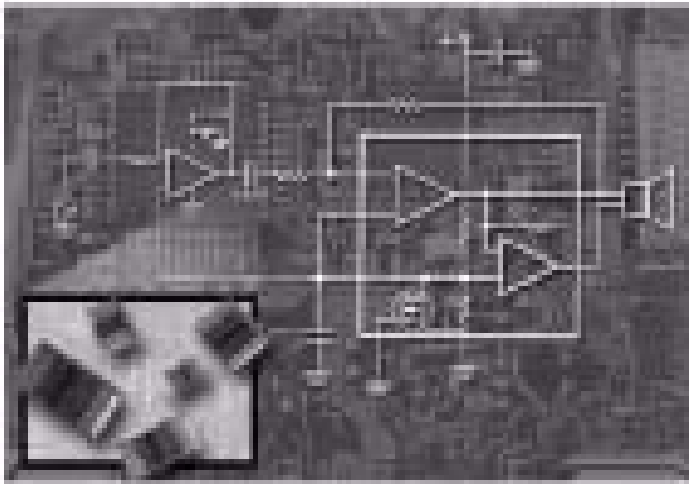

Type FCA acrylic film chips are non-inductive stacked metallized film capacitors which feature large capacitance values in standard surface mount case sizes.

### Highlights

- Smallest film chips
- No piezoelectric effect
- Non-polarized, non-magnetic
- Low ESR
- 1.0  $\mu\text{F}/10\text{V}$  in 1206 case

### Filtering • Decoupling • Noise Attenuation • Distortion Free Audio

Type FCA acrylic film capacitors offer high capacitance values in standard surface mount case sizes. They excel in attenuating DC power bus noise, and as ripple filters in dc to dc power conversion circuits. As coupling capacitors in audio circuits, they yield distortion free sound and better high frequency filtering. The 1.0  $\mu\text{F}$  10 Vdc rating offers a film capacitor that is a direct replacement for tantalum “A” case capacitors. The nonpolar FCA capacitor has lower ESR

and lower DCL than an equivalent tantalum capacitor, and in high frequency applications it takes a tantalum capacitor with ten times the capacitance to perform as well as the FCA capacitor.

The capacitor is constructed of noninductive stacked layers of metallized acrylic resin film with lead free solder (Sn/Ag/Cu) plated copper alloy terminals.

### Specifications

<b>Capacitance Range:</b>	0.10 $\mu\text{F}$ to 1.0 $\mu\text{F}$
<b>Capacitance Tolerance:</b>	$\pm 20\%$ @ 1 kHz and +20 °C
<b>Rated Voltage:</b>	16 Vdc [1.0 $\mu\text{F}$ in 1206 case, 10 Vdc]
<b>AC Voltage Rating:</b>	12 Vrms
<b>Operating Temperature Range:</b>	-40 °C to +85 °C
<b>Dissipation Factor:</b>	0.015 @ 1 kHz and +20 °C
<b>Dielectric Strength:</b>	175% of rated voltage for 5 seconds
<b>Insulation Resistance (IR):</b>	After 1 minute @ 10 Vdc; +20 °C

IR > 1000 M $\Omega$  (C  $\leq$  0.33  $\mu\text{F}$ )  
IR > 300 M $\Omega$ · $\mu\text{F}$  (C > 0.33  $\mu\text{F}$ )

**Resistance to Soldering:** The capacitor can withstand being heated in an oven at 235 °C for 200 seconds



Complies with the EU Directive 2002/95/EC requirement restricting the use of Lead (Pb), Mercury (Hg), Cadmium (Cd), Hexavalent chromium (Cr(VI)), PolyBrominated Biphenyls (PBB) and PolyBrominated Diphenyl Ethers (PBDE).

# Type FCA Acrylic Surface Mount Film Capacitors

## Specifications

### Moisture Resistance:

After 500 hours with rated voltage applied at +40 °C and 90 to 95% RH, the capacitor will meet the following limits:

$\Delta C = +20/-3\%$  of the initial measured value

DF  $\leq 2.25\%$  (at 1 kHz)

IR > 100M $\Omega$  (C  $\leq 0.33 \mu\text{F}$ )

IR > 30M $\Omega \cdot \mu\text{F}$  (C > 0.33  $\mu\text{F}$ )

Dielectric Strength: Capacitor will withstand 130% of the rated voltage for 1 minute.

### Life Test:

Apply 125% of the rated DC working voltage at 85 °C for 1000 hours, and then stabilize them to +20 °C.

Capacitors will meet the following limits:

C = +7%/-20% of the initial measured value

DF  $\leq 1.65\%$  (at 1 kHz)

IR > 300M $\Omega$  (C  $\leq 0.33 \mu\text{F}$ )

IR > 100M $\Omega \cdot \mu\text{F}$  (C > 0.33  $\mu\text{F}$ )

## Ratings

Capacitance ( $\mu\text{F}$ )	Catalog Part Number	dv/dt (V/ $\mu\text{s}$ )	Maximum Current						
			10kHz (Arms)	20kHz (Arms)	50kHz (Arms)	100kHz (Arms)	200kHz (Arms)	500kHz (Arms)	1MHz (Arms)
<b>10 Vdc</b>									
1.00	FCA1206A105M-H3	3	0.60	0.76	1.05	1.220	1.35	1.43	1.43
<b>16 Vdc</b>									
.10	FCA0805C104M-J2	19	0.15	0.21	0.3	0.375	0.46	0.58	0.65
.15	FCA1206C154M-H1	15	0.21	0.28	0.37	0.450	0.54	0.62	0.68
.22	FCA1206C224M-H1	13	0.25	0.33	0.45	0.550	0.66	0.76	0.84
.33	FCA1206C334M-H2	10	0.35	0.45	0.61	0.740	0.84	0.94	1.00
.47	FCA1206C474M-H3	7	0.39	0.52	0.71	0.860	1.00	1.10	1.17
.68	FCA1206C684M-H3	5	0.48	0.625	0.85	1.040	1.19	1.31	1.34
1.00	FCA1210C105M-G2	3	0.60	0.78	1.05	1.250	1.38	1.46	1.46

## Outline Drawing

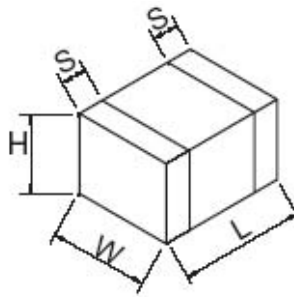

## Outline Dimensions

Part Number Suffix	Case Code	Inches				Millimeters			
		L ( $\pm 0.008\text{in.}$ )	W ( $\pm 0.008\text{in.}$ )	H ( $\pm 0.008\text{in.}$ )	S ( $\pm 0.012\text{in.}$ )	L ( $\pm 0.2\text{mm}$ )	W ( $\pm 0.2\text{mm}$ )	H ( $\pm 0.2\text{mm}$ )	S ( $\pm 0.3\text{mm}$ )
J2	0805	0.079	0.049	0.039	0.018	2.0	1.25	1.0	0.45
H1	1206	0.126	0.063	0.032	0.026	3.2	1.60	0.8	0.65
H2	1206	0.126	0.063	0.039	0.026	3.2	1.60	1.0	0.65
H3	1206	0.126	0.063	0.055	0.026	3.2	1.60	1.4	0.65
G2	1210	0.126	0.098	0.055	0.026	3.2	2.50	1.4	0.65

# Type FCA Acrylic Surface Mount Film Capacitors

## Temperature Characteristics

## Frequency Characteristics

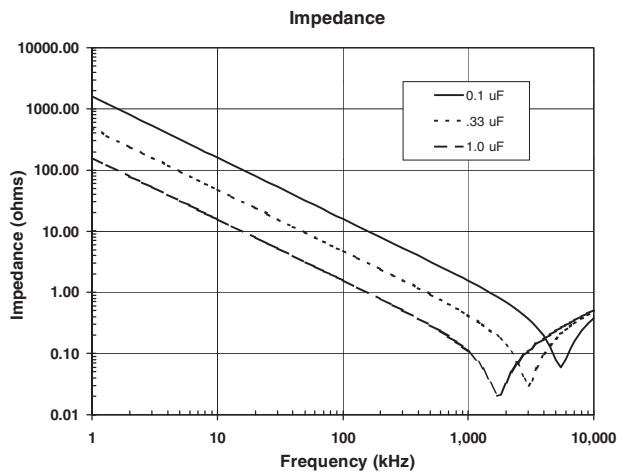
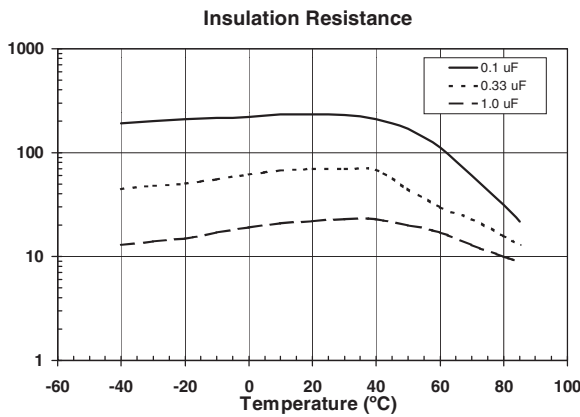
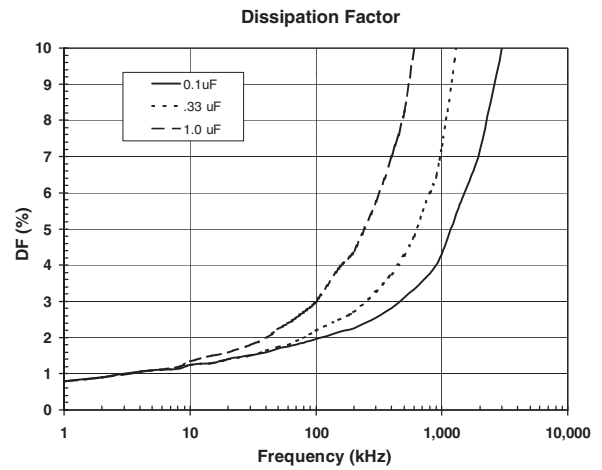
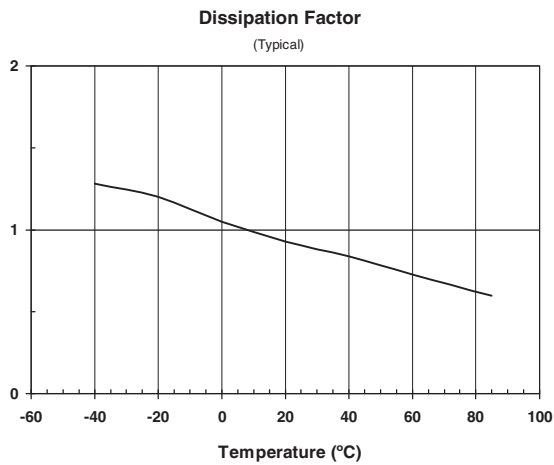
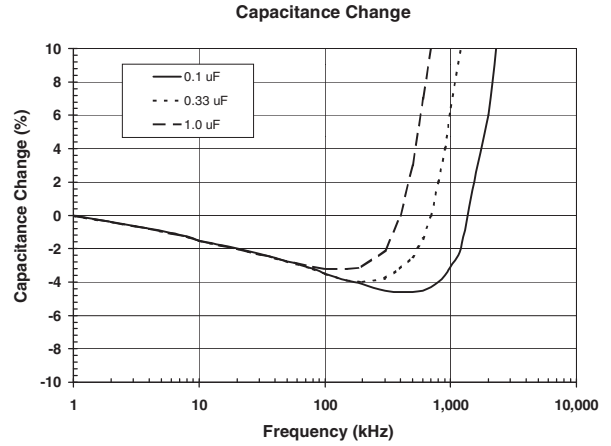
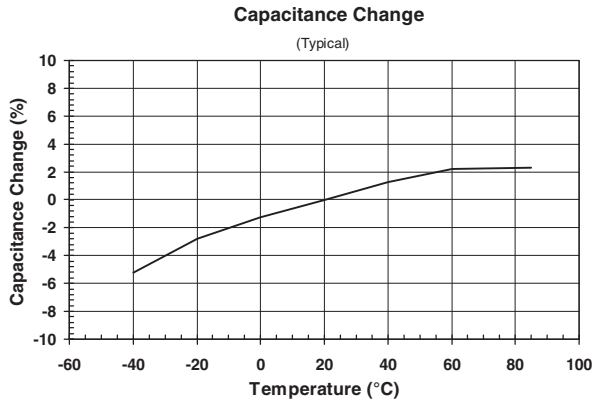

# Type FCA Acrylic Surface Mount Film Capacitors

## Typical Applications

Coupling Capacitor for Audio:

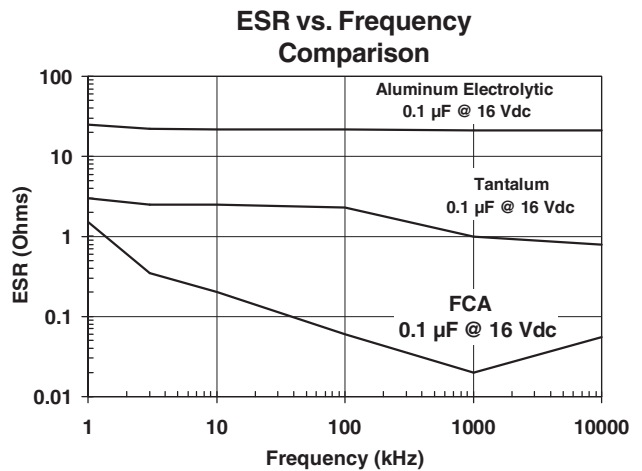
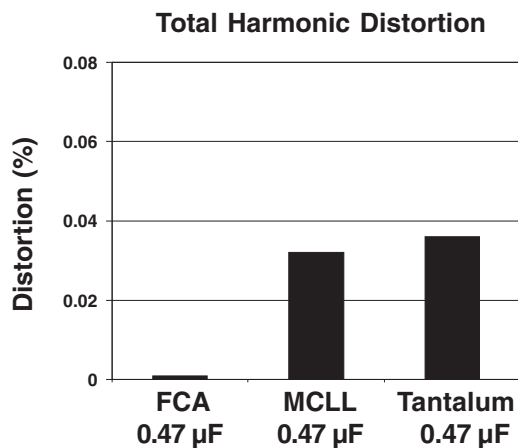
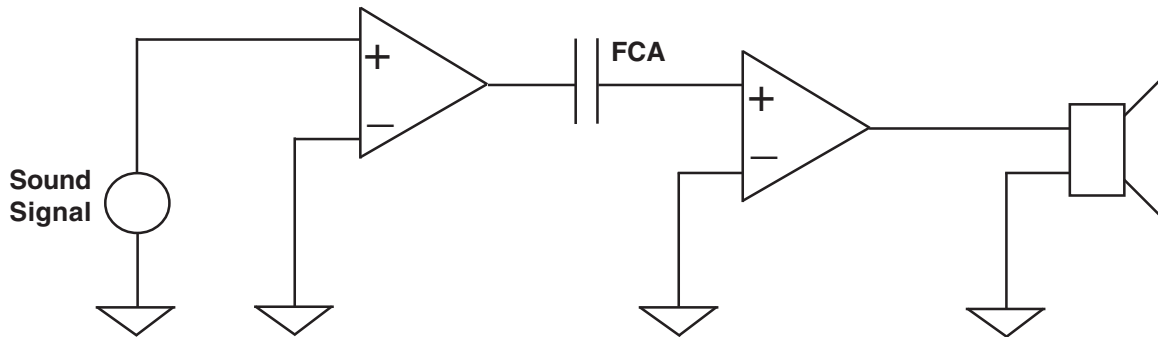

Using FCA capacitors in audio circuits can result in lower sound distortion. The low ESR, the absence of piezoelectric effects, and the non polar nature of the capacitor will eliminate sources of distortion in your audio circuits.

PLL Circuit: Cellular phone, Blue Tooth, Data Communication Card

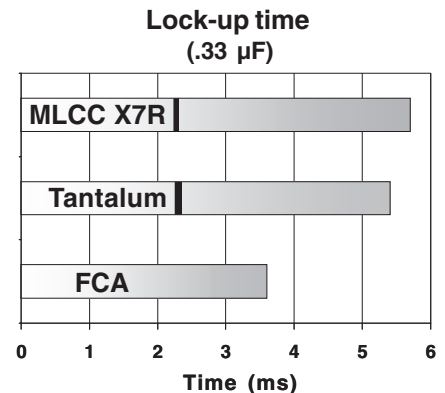
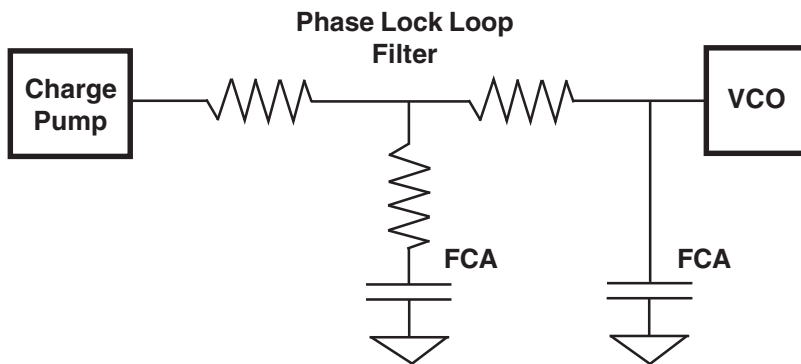

FCA surface mount film capacitors have advantages over tantalum and ceramic capacitors in PLL circuits. There are no piezoelectric effects to create noise, they are not polarized, and they result in faster signal lock-up time.

# Type FCA Acrylic Surface Mount Film Capacitors

## Typical Applications

### Filtering Performance:

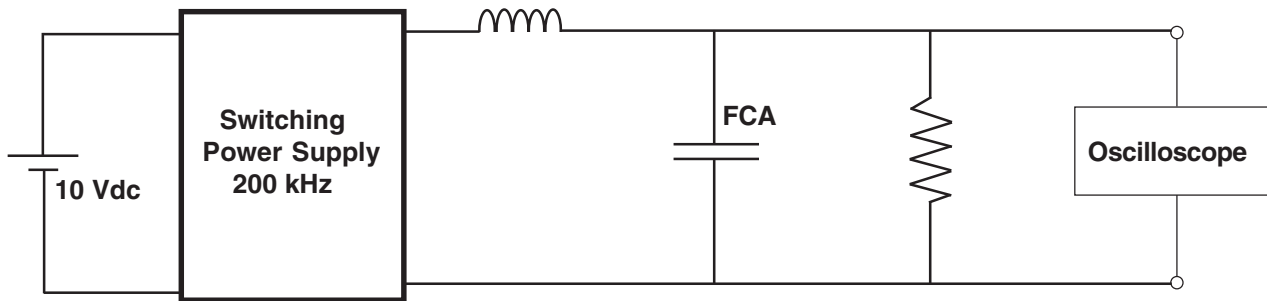

In the above circuit, one 1  $\mu\text{F}$  FCA capacitor results in the same ripple reduction performance as a 10  $\mu\text{F}$  tantalum capacitor at 200 kHz. With a 1  $\mu\text{F}$  tantalum capacitor in the circuit the measured ripple voltage was 70 mVpp, and with a 10  $\mu\text{F}$  tantalum or a 1  $\mu\text{F}$  FCA capacitor the ripple voltage was 8 mVpp.

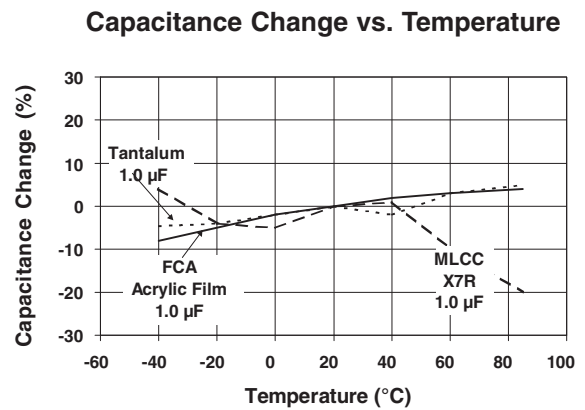
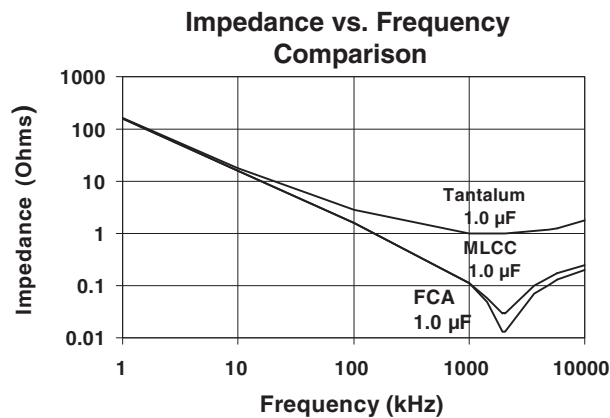

Type FCA capacitors have very low ESR and stable capacitance vs. temperature.

## Design Kits

See the Capacitor Kits section at the end of this catalog for design Kits containing various ratings of FCA, FCN and FCP surface mount film capacitors as well as kits for aluminum electrolytic, polymer aluminum, and mica surface mount capacitors