

MC74LVX574

Octal D-Type Flip-Flop with 3-State Outputs

The MC74LVX574 is an advanced high speed CMOS octal flip-flop with 3-state outputs. The inputs tolerate voltages up to 7.0 V, allowing the interface of 5.0 V systems to 3.0 V systems.

This 8-bit D-type flip-flop is controlled by a clock pulse input and an output enable input. When the output enable input is high, the eight outputs are in a high impedance state.

Features

- High Speed: $t_{PD} = 8.5 \text{ ns}$ (Typ) at $V_{CC} = 3.3 \text{ V}$
- Low Power Dissipation: $I_{CC} = 4 \mu\text{A}$ (Max) at $T_A = 25^\circ\text{C}$
- Power Down Protection Provided on Inputs
- Balanced Propagation Delays
- Low Noise: $V_{OLP} = 0.8 \text{ V}$ (Max)
- Pin and Function Compatible with Other Standard Logic Families
- Latchup Performance Exceeds 300 mA
- ESD Performance:
 - Human Body Model > 2000 V;
 - Machine Model > 200 V
- Pb-Free Packages are Available*

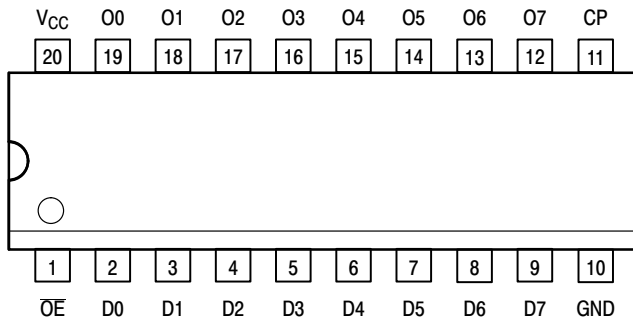

Figure 1. 20-Lead Pinout (Top View)



ON Semiconductor®

<http://onsemi.com>

MARKING DIAGRAMS

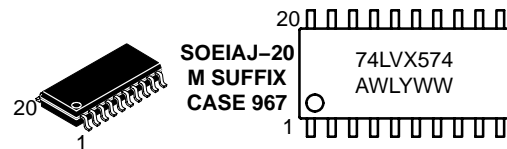
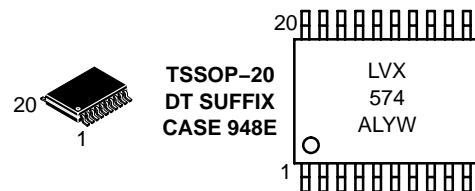
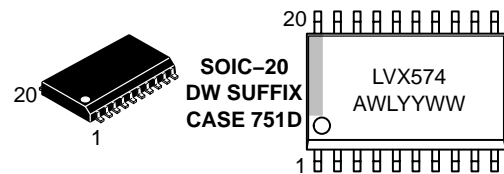

A = Assembly Location
L, WL = Wafer Lot
Y, YY = Year
W, WW = Work Week

ORDERING INFORMATION

See detailed ordering and shipping information in the package dimensions section on page 2 of this data sheet.

*For additional information on our Pb-Free strategy and soldering details, please download the ON Semiconductor Soldering and Mounting Techniques Reference Manual, SOLDERRM/D.

MC74LVX574

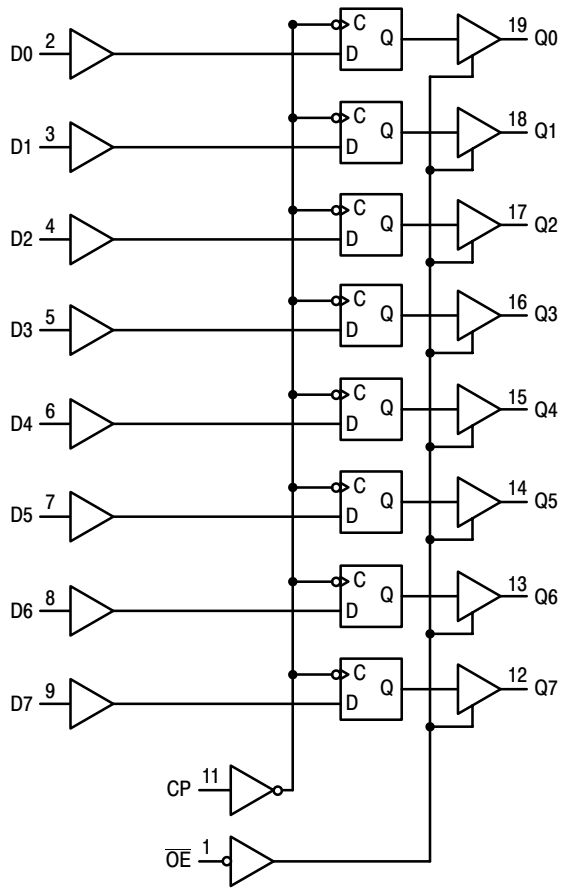

Figure 2. Logic Diagram

PIN NAMES

Pins	Function
\overline{OE}	Output Enable Input
CP	Clock Pulse Input
D0–D7	Data Inputs
O0–O7	3–State Latch Outputs

FUNCTION TABLE

INPUTS			OUTPUT
\overline{OE}	CP	D	Q
L	\nearrow	H	H
L	\searrow	L	L
L	L, H, \searrow	X	No Change
H	X	X	Z

ORDERING INFORMATION

Device	Package	Shipping†
MC74LVX574DWR2	SOIC–20	1000 Tape & Reel
MC74LVX574DWR2G	SOIC–20 (Pb–Free)	1000 Tape & Reel
MC74LVX574DT	TSSOP–20*	75 Units / Rail
MC74LVX574DTR2	TSSOP–20*	2500 Tape & Reel
MC74LVX574M	SOEIAJ–20	40 Units / Rail
MC74LVX574MG	SOEIAJ–20 (Pb–Free)	40 Units / Rail
MC74LVX574MEL	SOEIAJ–20	2000 Tape & Reel
MC74LVX574MELG	SOEIAJ–20 (Pb–Free)	2000 Tape & Reel

†For information on tape and reel specifications, including part orientation and tape sizes, please refer to our Tape and Reel Packaging Specifications Brochure, BRD8011/D.

*This package is inherently Pb–Free.

MC74LVX574

MAXIMUM RATINGS

Symbol	Parameter	Value	Unit
V _{CC}	DC Supply Voltage	-0.5 to +7.0	V
V _{in}	DC Input Voltage	-0.5 to +7.0	V
V _{out}	DC Output Voltage	-0.5 to V _{CC} +0.5	V
I _{IK}	Input Diode Current	-20	mA
I _{OK}	Output Diode Current	±20	mA
I _{out}	DC Output Current, per Pin	±25	mA
I _{CC}	DC Supply Current, V _{CC} and GND Pins	±75	mA
P _D	Power Dissipation	180	mW
T _{stg}	Storage Temperature	-65 to +150	°C

Maximum ratings are those values beyond which device damage can occur. Maximum ratings applied to the device are individual stress limit values (not normal operating conditions) and are not valid simultaneously. If these limits are exceeded, device functional operation is not implied, damage may occur and reliability may be affected.

RECOMMENDED OPERATING CONDITIONS

Symbol	Parameter	Min	Max	Unit
V _{CC}	DC Supply Voltage	2.0	3.6	V
V _{in}	DC Input Voltage	0	5.5	V
V _{out}	DC Output Voltage	0	V _{CC}	V
T _A	Operating Temperature, All Package Types	-40	+85	°C
Δt/ΔV	Input Rise and Fall Time	0	100	ns/V

DC ELECTRICAL CHARACTERISTICS

Symbol	Parameter	Test Conditions	V _{CC} V	T _A = 25°C			T _A = -40 to 85°C		Unit
				Min	Typ	Max	Min	Max	
V _{IH}	High-Level Input Voltage		2.0	1.5			1.5		V
			3.0	2.0			2.0		
			3.6	2.4			2.4		
V _{IL}	Low-Level Input Voltage		2.0			0.5		0.5	V
			3.0			0.8		0.8	
			3.6			0.8		0.8	
V _{OH}	High-Level Output Voltage (V _{in} = V _{IH} or V _{IL})	I _{OH} = -50μA I _{OH} = -50μA I _{OH} = -4mA	2.0	1.9	2.0		1.9		V
			3.0	2.9	3.0		2.9		
			3.0	2.58			2.48		
V _{OL}	Low-Level Output Voltage (V _{in} = V _{IH} or V _{IL})	I _{OL} = 50μA I _{OL} = 50μA I _{OL} = 4mA	2.0		0.0	0.1		0.1	V
			3.0		0.0	0.1		0.1	
			3.0		0.36		0.44		
I _{in}	Input Leakage Current	V _{in} = 5.5V or GND	3.6			±0.1		±1.0	μA
I _{OZ}	Maximum 3-State Leakage Current	V _{in} = V _{IL} or V _{IH} V _{out} = V _{CC} or GND	3.6			±0.2 5		±2.5	μA
I _{CC}	Quiescent Supply Current	V _{in} = V _{CC} or GND	3.6			4.0		40.0	μA

MC74LVX574

AC ELECTRICAL CHARACTERISTICS (Input $t_r = t_f = 3.0\text{ns}$)

Symbol	Parameter	Test Conditions	$T_A = 25^\circ\text{C}$			$T_A = -40 \text{ to } 85^\circ\text{C}$		Unit
			Min	Typ	Max	Min	Max	
f_{max}	Maximum Clock Frequency (50% Duty Cycle)	$V_{\text{CC}} = 2.7\text{V}$ $C_L = 15\text{pF}$ $C_L = 50\text{pF}$	60 45	115 60		50 40		ns
		$V_{\text{CC}} = 3.3 \pm 0.3\text{V}$ $C_L = 15\text{pF}$ $C_L = 50\text{pF}$	80 50	125 75		65 45		
t_{PLH} , t_{PHL}	Propagation Delay CP to O	$V_{\text{CC}} = 2.7\text{V}$ $C_L = 15\text{pF}$ $C_L = 50\text{pF}$		9.2 11.5	14.5 18.0	1.0 1.0	17.5 21.0	ns
		$V_{\text{CC}} = 3.3 \pm 0.3\text{V}$ $C_L = 15\text{pF}$ $C_L = 50\text{pF}$		8.5 11.0	13.2 16.7	1.0 1.0	15.5 19.0	
t_{PZL} , t_{PZH}	Output Enable Time $\overline{\text{OE}}$ to O	$V_{\text{CC}} = 2.7\text{V}$ $R_L = 1\text{k}\Omega$ $C_L = 50\text{pF}$		9.8 11.4	15.0 18.5	1.0 1.0	18.5 22.0	ns
		$V_{\text{CC}} = 3.3 \pm 0.3\text{V}$ $R_L = 1\text{k}\Omega$ $C_L = 50\text{pF}$		8.2 10.7	12.8 16.3	1.0 1.0	15.0 18.5	
t_{PLZ} , t_{PHZ}	Output Disable Time $\overline{\text{OE}}$ to O	$V_{\text{CC}} = 2.7\text{V}$ $R_L = 1\text{k}\Omega$ $C_L = 50\text{pF}$		12.1	19.1	1.0	22.0	ns
		$V_{\text{CC}} = 3.3 \pm 0.3\text{V}$ $R_L = 1\text{k}\Omega$ $C_L = 50\text{pF}$		11.0	15.0	1.0	17.0	
t_{OSHL} , t_{OSLH}	Output-to-Output Skew (Note 1)	$V_{\text{CC}} = 2.7\text{V}$ $C_L = 50\text{pF}$			1.5		1.5	ns
		$V_{\text{CC}} = 3.3 \pm 0.3\text{V}$ $C_L = 50\text{pF}$			1.5		1.5	

1. Skew is defined as the absolute value of the difference between the actual propagation delay for any two separate outputs of the same device. The specification applies to any outputs switching in the same direction, either HIGH-to-LOW (t_{OSHL}) or LOW-to-HIGH (t_{OSLH}); parameter guaranteed by design.

CAPACITIVE CHARACTERISTICS

Symbol	Parameter	$T_A = 25^\circ\text{C}$			$T_A = -40 \text{ to } 85^\circ\text{C}$		Unit
		Min	Typ	Max	Min	Max	
C_{in}	Input Capacitance		4	10		10	pF
C_{out}	Maximum Three-State Output Capacitance		6				pF
C_{PD}	Power Dissipation Capacitance (Note 2)		28				pF

2. C_{PD} is defined as the value of the internal equivalent capacitance which is calculated from the operating current consumption without load. Average operating current can be obtained by the equation: $I_{\text{CC(OPR)}} = C_{\text{PD}} \cdot V_{\text{CC}} \cdot f_{\text{in}} + I_{\text{CC}}/8$ (per latch). C_{PD} is used to determine the no-load dynamic power consumption; $P_{\text{D}} = C_{\text{PD}} \cdot V_{\text{CC}}^2 \cdot f_{\text{in}} + I_{\text{CC}} \cdot V_{\text{CC}}$.

NOISE CHARACTERISTICS (Input $t_r = t_f = 3.0\text{ns}$, $C_L = 50\text{pF}$, $V_{\text{CC}} = 3.3\text{V}$, Measured in SOIC Package)

Symbol	Characteristic	$T_A = 25^\circ\text{C}$		Unit
		Typ	Max	
V_{OLP}	Quiet Output Maximum Dynamic V_{OL}	0.5	0.8	V
V_{OLV}	Quiet Output Minimum Dynamic V_{OL}	-0.5	-0.8	V
V_{IHD}	Minimum High Level Dynamic Input Voltage		2.0	V
V_{ILD}	Maximum Low Level Dynamic Input Voltage		0.8	V

TIMING REQUIREMENTS (Input $t_r = t_f = 3.0\text{ns}$)

Symbol	Parameter	Test Conditions	$T_A = 25^\circ\text{C}$		$T_A = -40 \text{ to } 85^\circ\text{C}$		Unit
			Typ	Limit	Limit		
$t_{\text{w(h)}}$	Minimum Pulse Width, CP	$V_{\text{CC}} = 2.7\text{V}$ $V_{\text{CC}} = 3.3 \pm 0.3\text{V}$		6.5 5.0	7.5 5.0		ns
t_{su}	Minimum Setup Time, D to CP	$V_{\text{CC}} = 2.7\text{V}$ $V_{\text{CC}} = 3.3 \pm 0.3\text{V}$		5.0 3.5	5.0 3.5		ns
t_{h}	Minimum Hold Time, D to CP	$V_{\text{CC}} = 2.7\text{V}$ $V_{\text{CC}} = 3.3 \pm 0.3\text{V}$		1.5 1.5	1.5 1.5		ns

MC74LVX574

SWITCHING WAVEFORMS

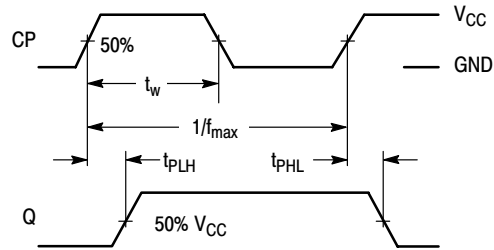

Figure 3.

\overline{OE}

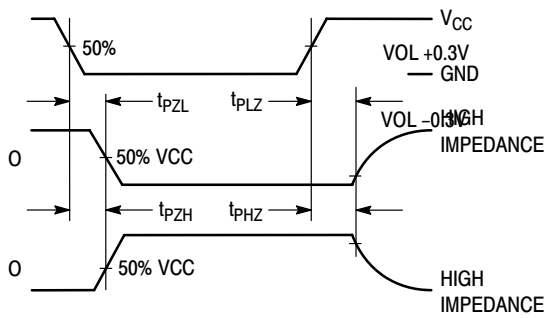

Figure 4.

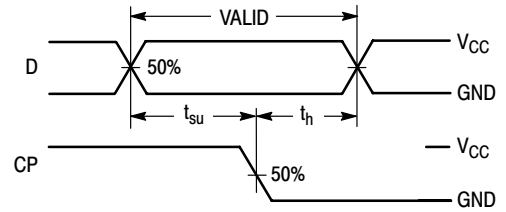
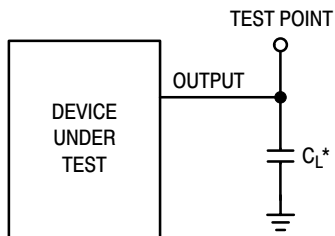

Figure 5.

TEST CIRCUITS



*Includes all probe and jig capacitance

Figure 6. Propagation Delay Test Circuit

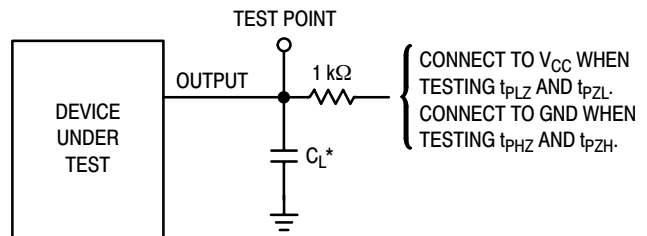

*Includes all probe and jig capacitance

Figure 7. Three-State Test Circuit

MC74LVX574

PACKAGE DIMENSIONS

SOIC-20
DW SUFFIX
CASE 751D-05
ISSUE G

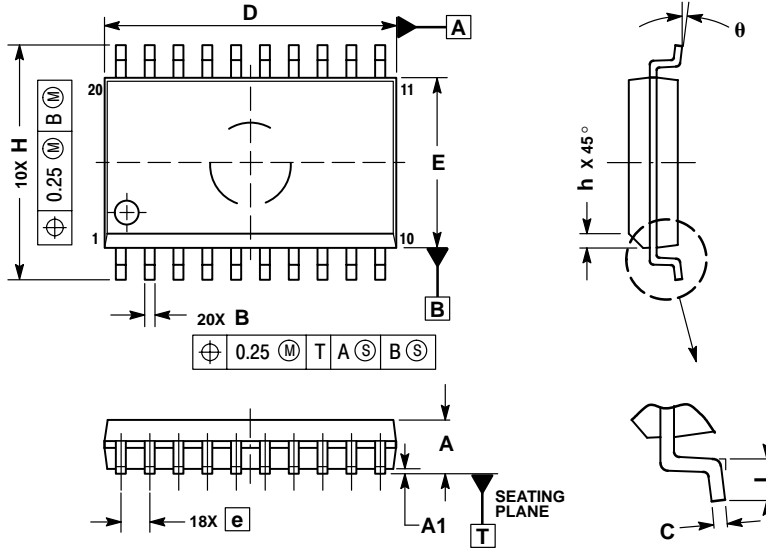

NOTES:

1. DIMENSIONS ARE IN MILLIMETERS.
2. INTERPRET DIMENSIONS AND TOLERANCES PER ASME Y14.5M, 1994.
3. DIMENSIONS D AND E DO NOT INCLUDE MOLD PROTRUSION.
4. MAXIMUM MOLD PROTRUSION 0.15 PER SIDE.
5. DIMENSION B DOES NOT INCLUDE DAMBAR PROTRUSION. ALLOWABLE PROTRUSION SHALL BE 0.13 TOTAL IN EXCESS OF B DIMENSION AT MAXIMUM MATERIAL CONDITION.

DIM	MILLIMETERS	
	MIN	MAX
A	2.35	2.65
A1	0.10	0.25
B	0.35	0.49
C	0.23	0.32
D	12.65	12.95
E	7.40	7.60
e	1.27 BSC	
H	10.05	10.55
h	0.25	0.75
L	0.50	0.90
theta	0°	7°

TSSOP-20
DT SUFFIX
CASE 948E-02
ISSUE B



NOTES:

1. DIMENSIONING AND TOLERANCING PER ANSI Y14.5M, 1982.
2. CONTROLLING DIMENSION: MILLIMETER.
3. DIMENSION A DOES NOT INCLUDE MOLD FLASH, PROTRUSIONS OR GATE BURRS. MOLD FLASH OR GATE BURRS SHALL NOT EXCEED 0.15 (0.006) PER SIDE.
4. DIMENSION B DOES NOT INCLUDE INTERLEAD FLASH OR PROTRUSION. INTERLEAD FLASH OR PROTRUSION SHALL NOT EXCEED 0.25 (0.010) PER SIDE.
5. DIMENSION K DOES NOT INCLUDE DAMBAR PROTRUSION. ALLOWABLE DAMBAR PROTRUSION SHALL BE 0.08 (0.003) TOTAL IN EXCESS OF THE K DIMENSION AT MAXIMUM MATERIAL CONDITION.
6. TERMINAL NUMBERS ARE SHOWN FOR REFERENCE ONLY.
7. DIMENSION A AND B ARE TO BE DETERMINED AT DATUM PLANE -W-.

DIM	MILLIMETERS		INCHES	
	MIN	MAX	MIN	MAX
A	6.40	6.60	0.252	0.260
B	4.30	4.50	0.169	0.177
C	---	1.20	---	0.047
D	0.05	0.15	0.002	0.006
F	0.50	0.75	0.020	0.030
G	0.65 BSC		0.026 BSC	
H	0.27	0.37	0.011	0.015
J	0.09	0.20	0.004	0.008
J1	0.09	0.16	0.004	0.006
K	0.19	0.30	0.007	0.012
K1	0.19	0.25	0.007	0.010
L	6.40 BSC		0.252 BSC	
M	0°	8°	0°	8°

MC74LVX574

PACKAGE DIMENSIONS

SOEIAJ-20
M SUFFIX
CASE 967-01
ISSUE O

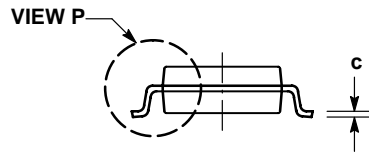
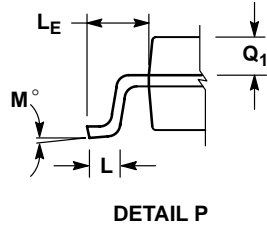
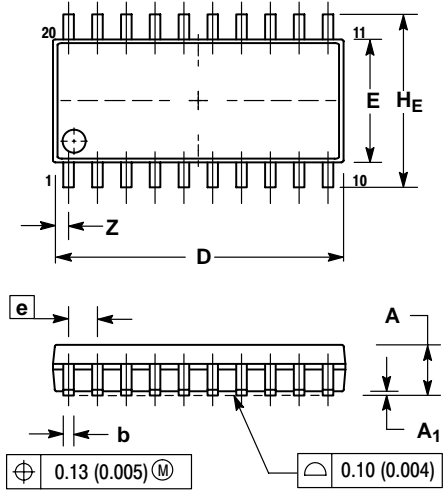

NOTES:

1. DIMENSIONING AND TOLERANCING PER ANSI Y14.5M, 1982.
2. CONTROLLING DIMENSION: MILLIMETER.
3. DIMENSIONS D AND E DO NOT INCLUDE MOLD FLASH OR PROTRUSIONS AND ARE MEASURED AT THE PARTING LINE. MOLD FLASH OR PROTRUSIONS SHALL NOT EXCEED 0.15 (0.006) PER SIDE.
4. TERMINAL NUMBERS ARE SHOWN FOR REFERENCE ONLY.
5. THE LEAD WIDTH DIMENSION (b) DOES NOT INCLUDE DAMBAR PROTRUSION. ALLOWABLE DAMBAR PROTRUSION SHALL BE 0.08 (0.003) TOTAL IN EXCESS OF THE LEAD WIDTH DIMENSION AT MAXIMUM MATERIAL CONDITION. DAMBAR CANNOT BE LOCATED ON THE LOWER RADIUS OR THE FOOT. MINIMUM SPACE BETWEEN PROTRUSIONS AND ADJACENT LEAD TO BE 0.46 (0.018).

DIM	MILLIMETERS		INCHES	
	MIN	MAX	MIN	MAX
A	---	2.05	---	0.081
A ₁	0.05	0.20	0.002	0.008
b	0.35	0.50	0.014	0.020
c	0.18	0.27	0.007	0.011
D	12.35	12.80	0.486	0.504
E	5.10	5.45	0.201	0.215
e	1.27 BSC		0.050 BSC	
HE	7.40	8.20	0.291	0.323
LE	0.50	0.85	0.020	0.033
L	1.10	1.50	0.043	0.059
M	0°	10°	0°	10°
Q ₁	0.70	0.90	0.028	0.035
Z	---	0.81	---	0.032

MC74LVX574

ON Semiconductor and  are registered trademarks of Semiconductor Components Industries, LLC (SCILLC). SCILLC reserves the right to make changes without further notice to any products herein. SCILLC makes no warranty, representation or guarantee regarding the suitability of its products for any particular purpose, nor does SCILLC assume any liability arising out of the application or use of any product or circuit, and specifically disclaims any and all liability, including without limitation special, consequential or incidental damages. "Typical" parameters which may be provided in SCILLC data sheets and/or specifications can and do vary in different applications and actual performance may vary over time. All operating parameters, including "Typicals" must be validated for each customer application by customer's technical experts. SCILLC does not convey any license under its patent rights nor the rights of others. SCILLC products are not designed, intended, or authorized for use as components in systems intended for surgical implant into the body, or other applications intended to support or sustain life, or for any other application in which the failure of the SCILLC product could create a situation where personal injury or death may occur. Should Buyer purchase or use SCILLC products for any such unintended or unauthorized application, Buyer shall indemnify and hold SCILLC and its officers, employees, subsidiaries, affiliates, and distributors harmless against all claims, costs, damages, and expenses, and reasonable attorney fees arising out of, directly or indirectly, any claim of personal injury or death associated with such unintended or unauthorized use, even if such claim alleges that SCILLC was negligent regarding the design or manufacture of the part. SCILLC is an Equal Opportunity/Affirmative Action Employer. This literature is subject to all applicable copyright laws and is not for resale in any manner.

PUBLICATION ORDERING INFORMATION

LITERATURE FULFILLMENT:

Literature Distribution Center for ON Semiconductor
P.O. Box 61312, Phoenix, Arizona 85082-1312 USA
Phone: 480-829-7710 or 800-344-3860 Toll Free USA/Canada
Fax: 480-829-7709 or 800-344-3867 Toll Free USA/Canada
Email: orderlit@onsemi.com

N. American Technical Support: 800-282-9855 Toll Free
USA/Canada

Japan: ON Semiconductor, Japan Customer Focus Center
2-9-1 Kamimeguro, Meguro-ku, Tokyo, Japan 153-0051
Phone: 81-3-5773-3850

ON Semiconductor Website: <http://onsemi.com>

Order Literature: <http://www.onsemi.com/litorder>

For additional information, please contact your
local Sales Representative.