

# Chip Beads(SMD) For Signal Line

Conformity to RoHS Directive

## MMZ Series MMZ2012 Type

### FEATURES

- Chip bead(impeder), MMZ series offers 4 construction materials.
- Size standardized for use by automatic assembly equipment.  
No preferred orientation.
- Either flow or reflow soldering methods can be used due to electroplating of the terminal electrodes.
- High reliability due to an entirely monolithic structure.
- Closed magnetic circuit structure allows high-density installation while preventing crosstalk between circuits.
- Low DC resistance structure of electrode prevents wasteful electric power consumption.
- The products contain no lead and also support lead-free soldering.
- It is a product conforming to RoHS directive.

### APPLICATIONS

Removal of signal line noises of cellular phones, PCs, note PCs, TVs, TV tuners, STBs, audio players, DVDs, DSCs, DVCs, game machines, digital photo frames, car navigation system, PNDs, etc.

### PRODUCT IDENTIFICATION

MMZ	2012	R	121	A	T
(1)	(2)	(3)	(4)	(5)	(6)

- (1) Series name
- (2) Dimensions L×W
- (3) Material code
- (4) Nominal impedance  
121:120Ω at 100MHz
- (5) Characteristic type
- (6) Packaging style  
T:Taping

### HANDLING AND PRECAUTIONS

- Before soldering, be sure to preheat components. The preheating temperature should be set so that the temperature difference between the solder temperature and product temperature does not exceed 150°C.
- After mounting components onto the printed circuit board, do not apply stress through board bending or mishandling.
- Do not expose the inductors to stray magnetic fields.
- Avoid static electricity discharge during handling.
- When hand soldering, apply the soldering iron to the printed circuit board only. Temperature of the iron tip should not exceed 350°C. Soldering time should not exceed 3 seconds.

• Conformity to RoHS Directive: This means that, in conformity with EU Directive 2002/95/EC, lead, cadmium, mercury, hexavalent chromium, and specific bromine-based flame retardants, PBB and PBDE, have not been used, except for exempted applications.

• Please contact our Sales office when your application are considered the following:  
The device's failure or malfunction may directly endanger human life (e.g. application for automobile/aircraft/medical/nuclear power devices, etc.)

• All specifications are subject to change without notice.

### MATERIAL CHARACTERISTICS

**R material:** For wide frequency applications calling for broad impedance characteristics.

For digital signal line applications calling requiring good waveform integrity. Impedance values selected for effectiveness at 10 to 200MHz.

**S material:** Standard type that features impedance characteristics similar to those of a typical ferrite core.

For signal line applications in which the blocking region is near 100MHz. Impedance values selected for effectiveness at 40 to 300MHz.

**Y material:** High frequency range type intended for the 100MHz region and above.

For signal line applications in which the signal frequency is far from the cutoff frequency. Impedance values selected for effectiveness at 80 to 400MHz.

**D material:** For applications calling for low insertion loss at low frequencies and sharply increasing impedance at high frequencies. Designed for high impedance at high frequencies (200 to 500MHz) for signal line applications.

### TYPICAL MATERIAL CHARACTERISTICS

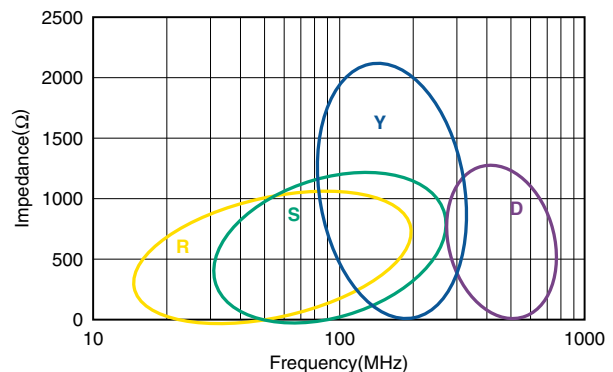

## SHAPES AND DIMENSIONS/RECOMMENDED PC BOARD PATTERN

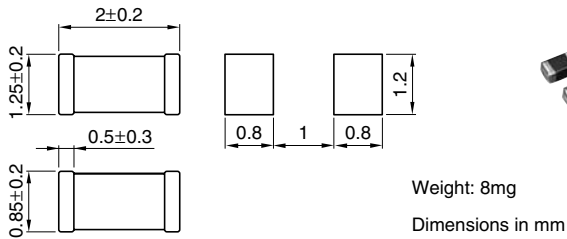

## TEMPERATURE RANGES

Operating/storage -55 to +125°C

## PACKAGING STYLE AND QUANTITIES

Packaging style Quantity  
Taping 4000 pieces/reel

## RECOMMENDED SOLDERING CONDITION REFLOW SOLDERING

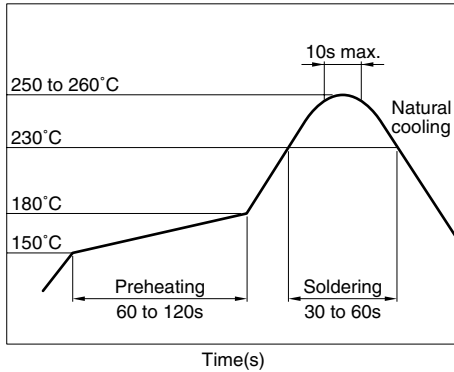

## ELECTRICAL CHARACTERISTICS

Part No.	Impedance ( $\Omega$ ) $\pm$ 25% [100MHz]*	DC resistance ( $\Omega$ )max.	Rated current (mA)max.
MMZ2012R150A	15	0.05	1500
MMZ2012R300A	30	0.05	1500
MMZ2012R600A	60	0.1	1000
MMZ2012R121A	120	0.12	800
MMZ2012R301A	300	0.15	600
MMZ2012R601A	600	0.2	500
MMZ2012R102A	1000	0.3	500
MMZ2012S400A	40	0.1	1000
MMZ2012S800A	80	0.1	800
MMZ2012S121A	120	0.15	800
MMZ2012S181A	180	0.15	600
MMZ2012S301A	300	0.2	600
MMZ2012S601A	600	0.3	500
MMZ2012S102A	1000	0.35	500
MMZ2012Y150B	15	0.05	1500
MMZ2012Y300B	30	0.05	1500
MMZ2012Y600B	60	0.1	1000
MMZ2012Y121B	120	0.12	800
MMZ2012Y301B	300	0.15	600
MMZ2012Y601B	600	0.2	500
MMZ2012Y102B	1000	0.3	500
MMZ2012Y152B	1500	0.4	500
MMZ2012Y202B	2000	0.5	400
MMZ2012D800B	80	0.3	500
MMZ2012D121B	120	0.3	500
MMZ2012D301B	300	0.5	400

\* Test equipment: E4991A or equivalent  
Test tool: 16192A or equivalent  
Test temperature: 25 $\pm$ 10°C

## TYPICAL ELECTRICAL CHARACTERISTICS Z, X, R vs. FREQUENCY CHARACTERISTICS

### MMZ2012R150A

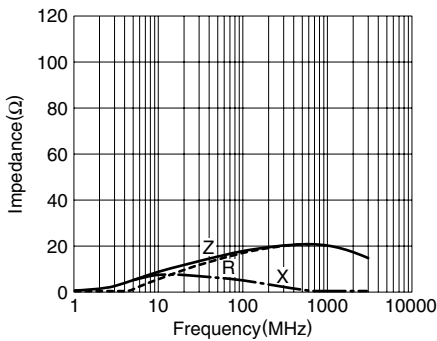

### MMZ2012R300A

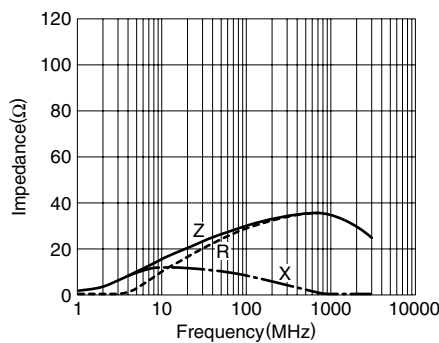

### MMZ2012R600A

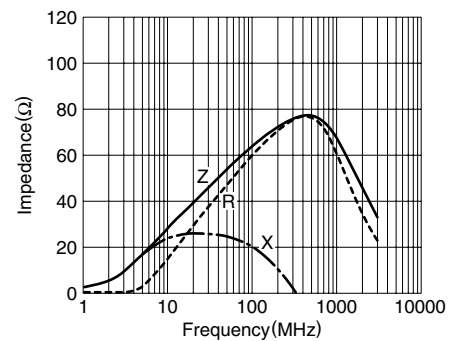

### MMZ2012R121A

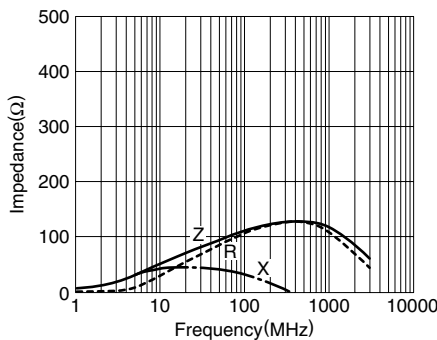

### MMZ2012R301A

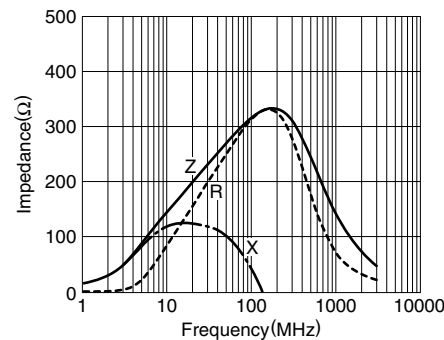

### MMZ2012R601A

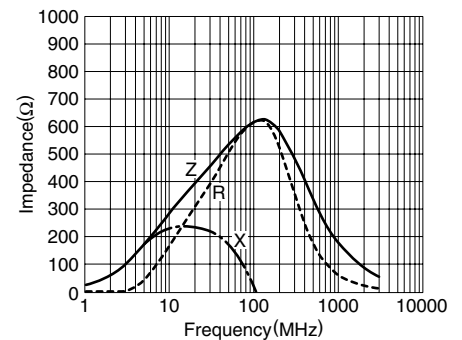

• All specifications are subject to change without notice.

### TYPICAL ELECTRICAL CHARACTERISTICS

#### Z, X, R vs. FREQUENCY CHARACTERISTICS

**MMZ2012R102A**

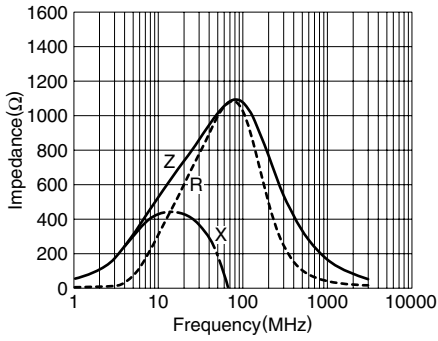

**MMZ2012S400A**

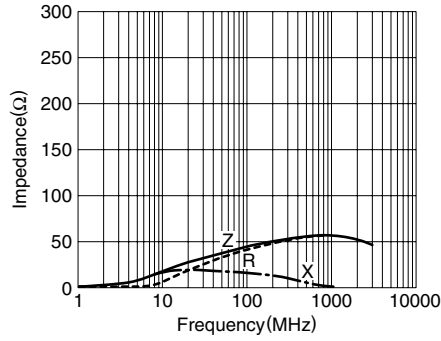

**MMZ2012S800A**

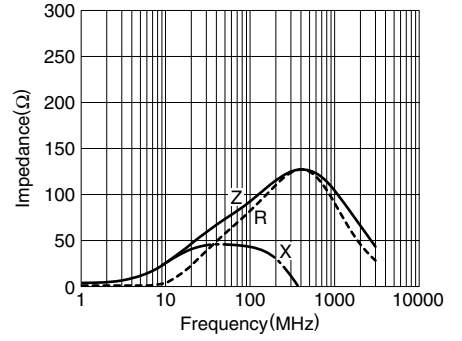

**MMZ2012S121A**

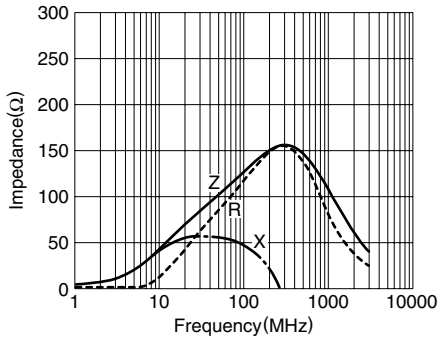

**MMZ2012S181A**

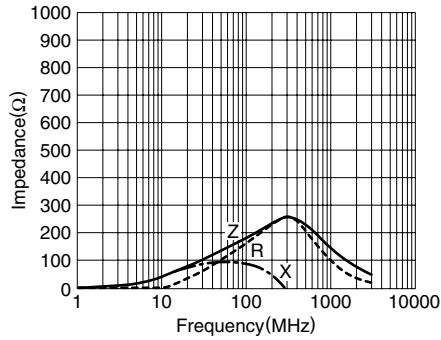

**MMZ2012S301A**

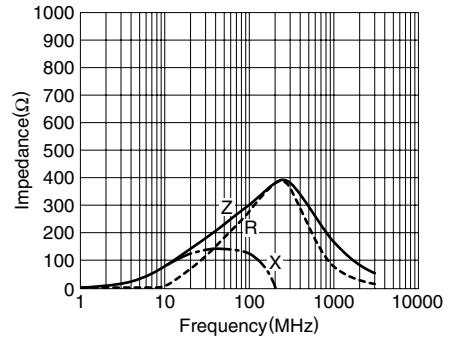

**MMZ2012S601A**

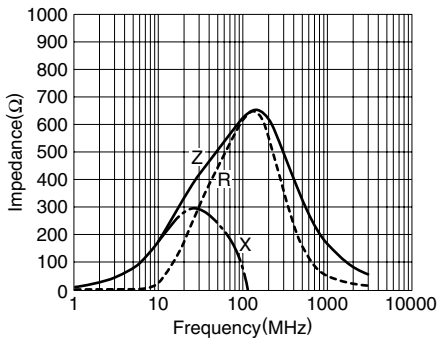

**MMZ2012S102A**

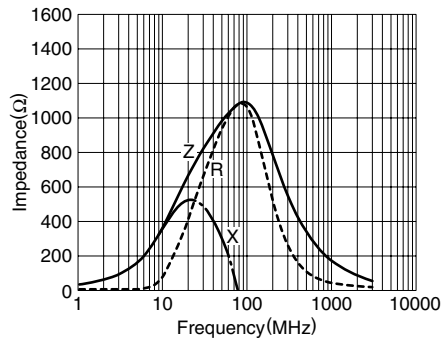

**MMZ2012Y150B**

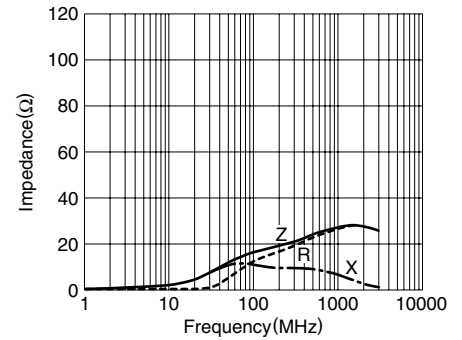

**MMZ2012Y300B**

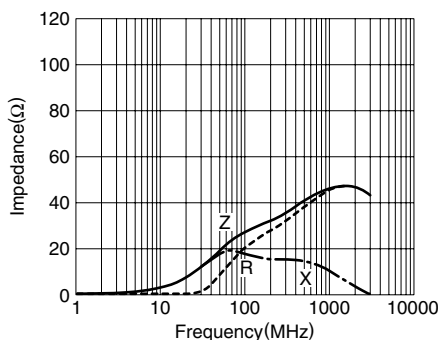

**MMZ2012Y600B**

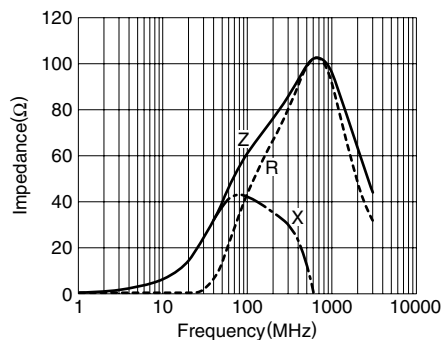

**MMZ2012Y121B**

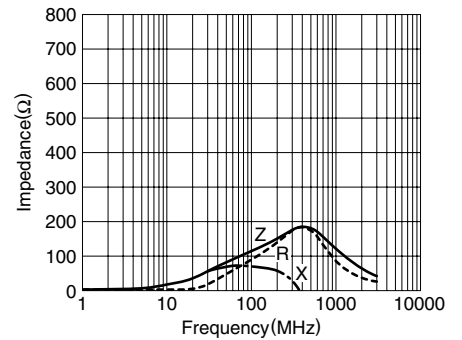

• All specifications are subject to change without notice.

### TYPICAL ELECTRICAL CHARACTERISTICS

#### Z, X, R vs. FREQUENCY CHARACTERISTICS

MMZ2012Y301B

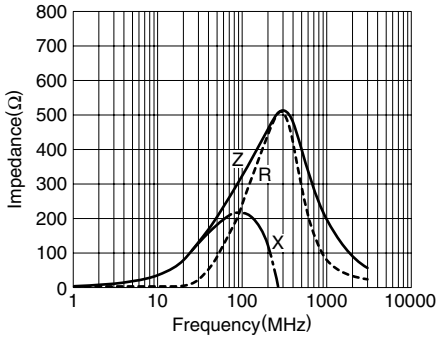

MMZ2012Y601B

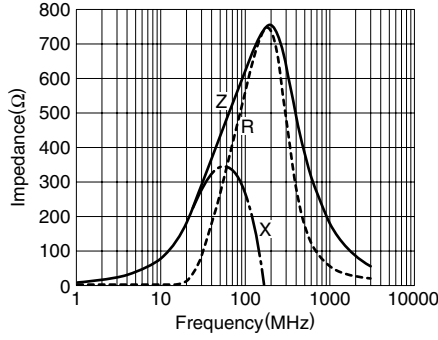

MMZ2012Y102B

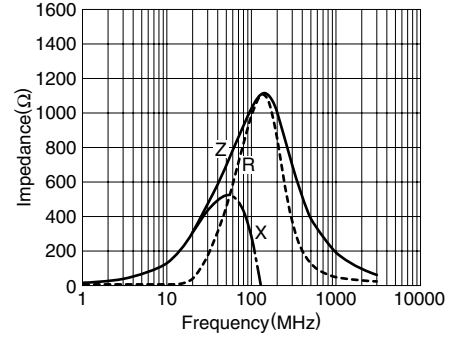

MMZ2012Y152B

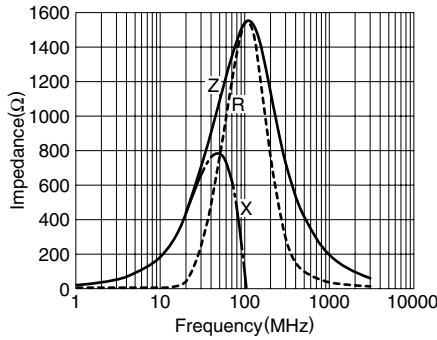

MMZ2012Y202B

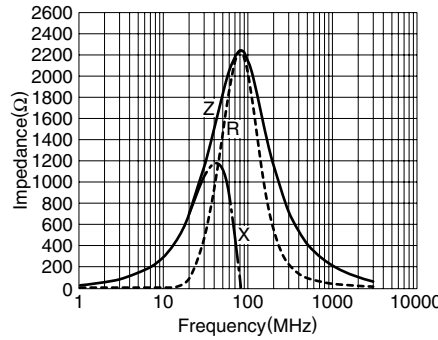

MMZ2012D800B

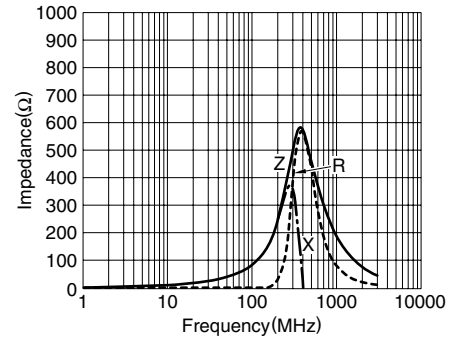

MMZ2012D121B

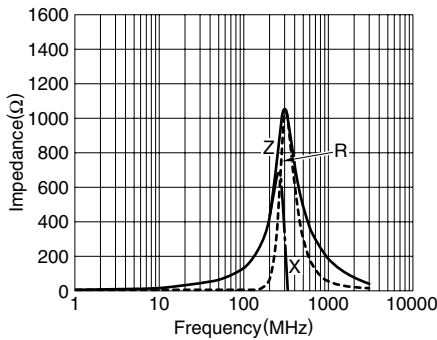

MMZ2012D301B

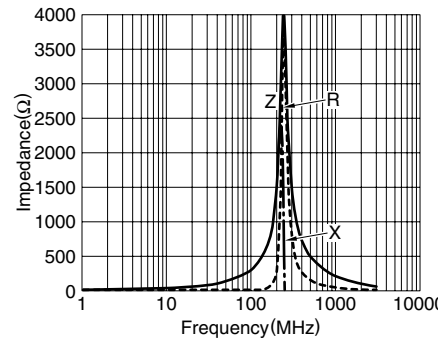

### PACKAGING STYLES

#### REEL DIMENSIONS

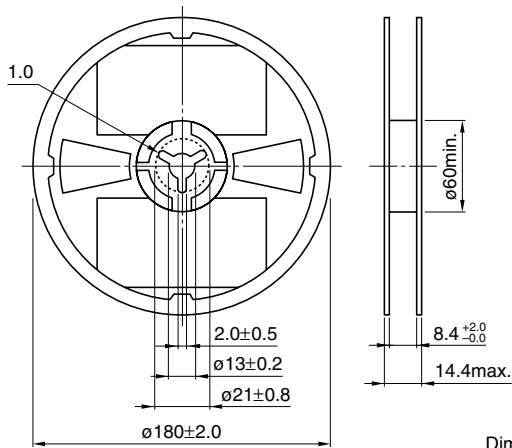

Dimensions in mm

#### TAPE DIMENSIONS

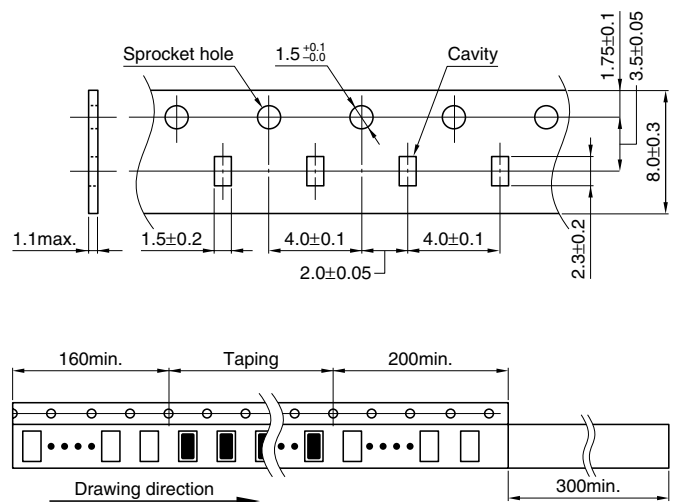

Dimensions in mm

• All specifications are subject to change without notice.