

TRISIL™ FOR TELECOM EQUIPMENT PROTECTION

FEATURES

- Bidirectional crowbar protection
- Voltage range from 62V to 270V
- Low capacitance from 10pF to 20pF typ. @ 50V
- Low leakage current: $I_R = 2\mu\text{A}$ max.
- Holding current: $I_H = 150$ mA min.
- Repetitive peak pulse current:
 $I_{PP} = 30$ A (10/1000 μs)

MAIN APPLICATIONS

Telecommunication equipment such as:

- Analog and digital line cards (xDSL, T1/E1, ISDN...).
- Terminals (phone, fax, modem...) and central office equipment.

DESCRIPTION

The SMP30-xxx series has been designed to protect telecommunication equipment against lightning and transient induced by AC power lines. The package / die size ratio has been optimized by using the SMA package.

BENEFITS

Trisils are not subject to ageing and provide a fail safe mode in short circuit for a better protection. They are used to help equipment to meet various standards such as UL1950, IEC950 / CSA C22.2, UL1459 and FCC part 68.

Trisils have UL94 V0 approved resin.

SMA package is JEDEC registered (DO-214AC).

Trisils are UL497B approved (file: E136224).

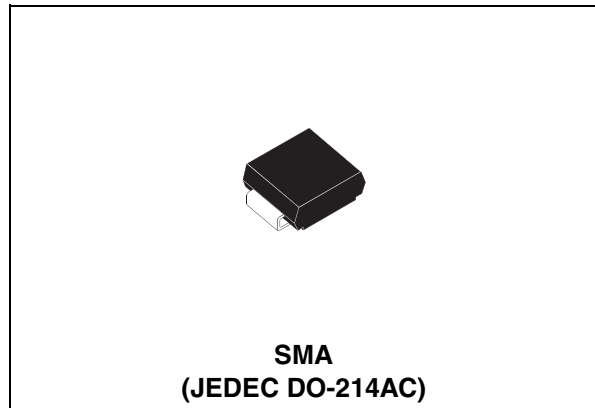


Table 1: Order Codes

Part Number	Marking
SMP30-62	QAA
SMP30-68	QAB
SMP30-100	QAC
SMP30-120	QAD
SMP30-130	QAE
SMP30-180	QAF
SMP30-200	QAG
SMP30-220	QAH
SMP30-240	QAI
SMP30-270	QAJ

Figure 1: Schematic Diagram

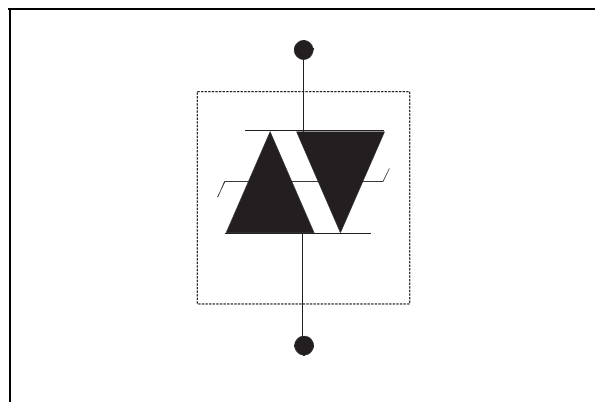


Table 2: In compliance with the following standards

STANDARD	Peak Surge Voltage (V)	Waveform Voltage	Required peak current (A)	Current waveform	Minimum serial resistor to meet standard (Ω)
GR-1089 Core First level	2500	2/10 μ s	500	2/10 μ s	20
	1000	10/1000 μ s	100	10/1000 μ s	24
GR-1089 Core Second level	5000	2/10 μ s	500	2/10 μ s	40
GR-1089 Core Intra-building	1500	2/10 μ s	100	2/10 μ s	0
ITU-T-K20/K21	6000 1500	10/700 μ s	150 37.5	5/310 μ s	110 0
ITU-T-K20 (IEC61000-4-2)	8000 15000	1/60 ns	ESD contact discharge ESD air discharge		0 0
VDE0433	4000	10/700 μ s	100	5/310 μ s	60
	2000		50		10
VDE0878	4000	1.2/50 μ s	100	1/20 μ s	18
	2000		50		0
IEC61000-4-5	4000	10/700 μ s	100	5/310 μ s	60
	4000	1.2/50 μ s	100	8/20 μ s	18
FCC Part 68, lightning surge type A	1500	10/160 μ s	200	10/160 μ s	26
	800	10/560 μ s	100	10/560 μ s	15
FCC Part 68, lightning surge type B	1000	9/720 μ s	25	5/320 μ s	0

Table 3: Absolute Ratings ($T_{amb} = 25^{\circ}\text{C}$)

Symbol	Parameter		Value	Unit
I_{PP}	Repetitive peak pulse current (see figure 2)	10/1000 μ s	30	A
		8/20 μ s	70	
		10/560 μ s	35	
		5/310 μ s	40	
		10/160 μ s	45	
		1/20 μ s	70	
		2/10 μ s	100	
I_{FS}	Fail-safe mode : maximum current (note 1)	8/20 μ s	2.5	kA
I_{TSM}	Non repetitive surge peak on-state current (sinusoidal)	t = 0.2 s	14	A
		t = 1 s	10.5	
		t = 2 s	9	
		t = 15 mn	3	
I^2t	I^2t value for fusing	t = 16.6 ms	5.7	A^2s
		t = 20 ms	4.9	
T_{stg}	Storage temperature range		-55 to 150	$^{\circ}\text{C}$
T_j	Maximum junction temperature		150	
T_L	Maximum lead temperature for soldering during 10 s.		260	$^{\circ}\text{C}$

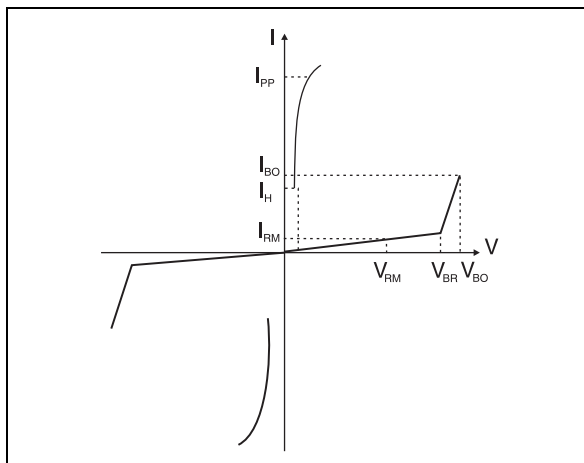
Note 1: in fail safe mode, the device acts as a short circuit.

Table 4: Thermal Resistances

Symbol	Parameter	Value	Unit
$R_{th(j-a)}$	Junction to ambient (with recommended footprint)	120	$^{\circ}\text{C}/\text{W}$
$R_{th(j-l)}$	Junction to leads	30	$^{\circ}\text{C}/\text{W}$

Table 5: Electrical Characteristics ($T_{amb} = 25^{\circ}\text{C}$)

Symbol	Parameter
V_{RM}	Stand-off voltage
V_{BR}	Breakdown voltage
V_{BO}	Breakover voltage
I_{RM}	Leakage current
I_{PP}	Peak pulse current
I_{BO}	Breakover current
I_H	Holding current
V_R	Continuous reverse voltage
I_R	Leakage current at V_R
C	Capacitance



Types	$I_{RM} @ V_{RM}$		$I_R @ V_R$		Dynamic	Static		I_H	C	C
	max.		max.		V_{BO}	$V_{BO} @ I_{BO}$	I_{BO}	min.	typ.	typ.
	μA	V	μA	V	max.	max.	max.	note 4	note 5	note 6
			note 1		note 2	note 3				
	μA	V	μA	V	V	V	mA	mA	pF	pF
SMP30-62	2	56	5	62	85	82	800	150	20	40
SMP30-68		61		68	93	90			20	40
SMP30-100		90		100	135	133			16	35
SMP30-120		108		120	160	160			16	30
SMP30-130		117		130	173	173			14	30
SMP30-180		162		180	235	240			12	25
SMP30-200		180		200	262	267			12	25
SMP30-220		198		220	285	293			10	20
SMP30-240		216		240	300	320			10	20
SMP30-270		243		270	350	360			10	20

Note 1: I_R measured at V_R guarantee $V_{BR} \min \geq V_R$

Note 2: see functional test circuit 1

Note 3: see test circuit 2

Note 4: see functional holding current test circuit 3

Note 5: $V_R = 50\text{V}$ bias, $V_{RMS}=1\text{V}$, $F=1\text{MHz}$

Note 6: $V_R = 2\text{V}$ bias, $V_{RMS}=1\text{V}$, $F=1\text{MHz}$

Figure 2: Pulse waveform

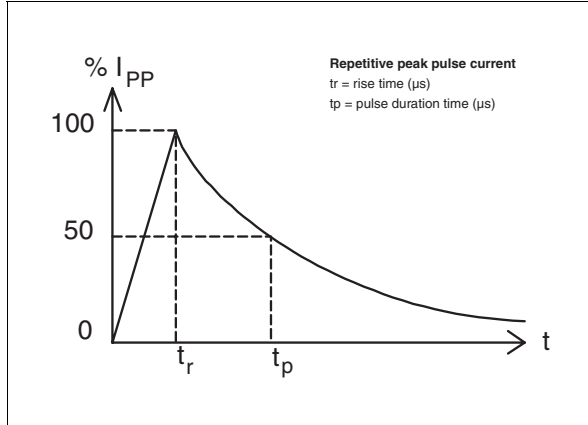


Figure 4: On-state voltage versus on-state current (typical values)

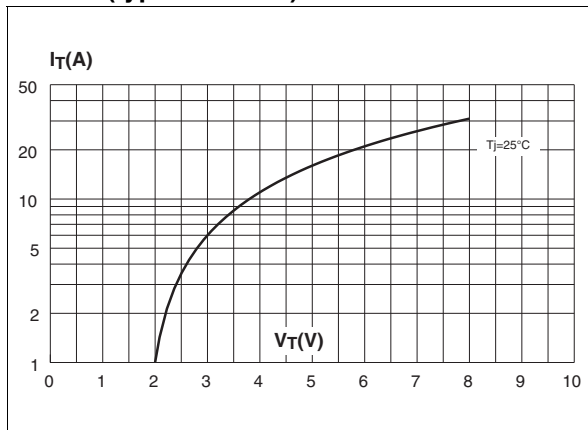


Figure 6: Relative variation of breakover voltage versus junction temperature

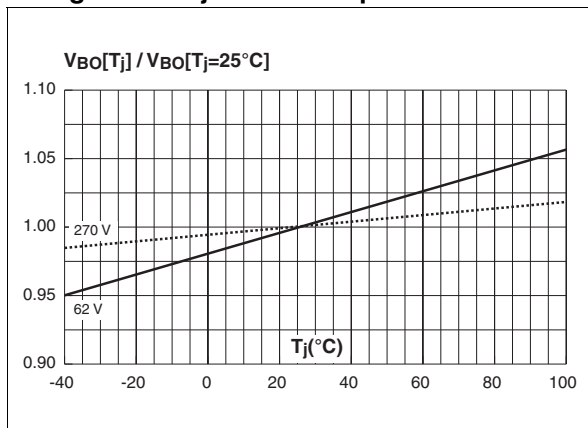


Figure 3: Non repetitive surge peak on-state current versus overload duration

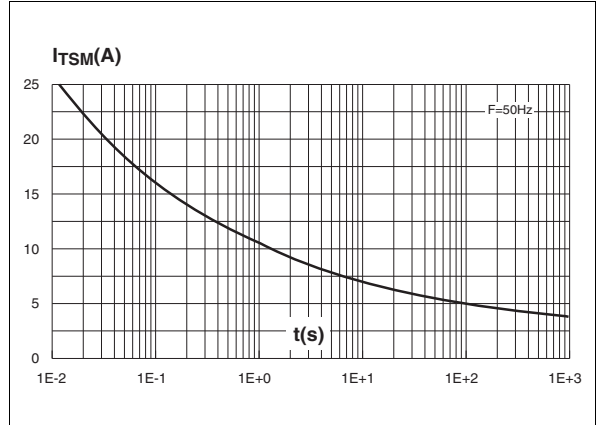


Figure 5: Relative variation of holding current versus junction temperature

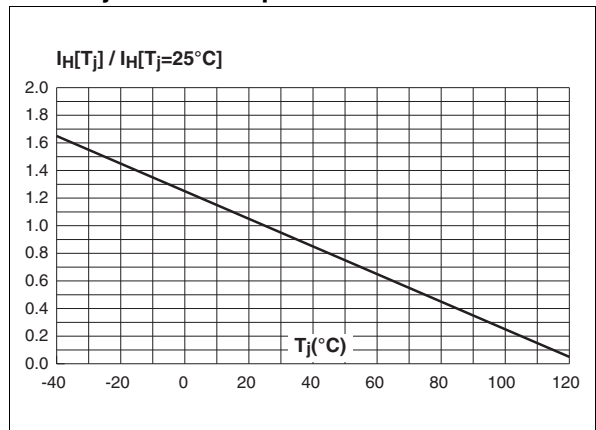


Figure 7: Relative variation of leakage current versus junction temperature (typical values)

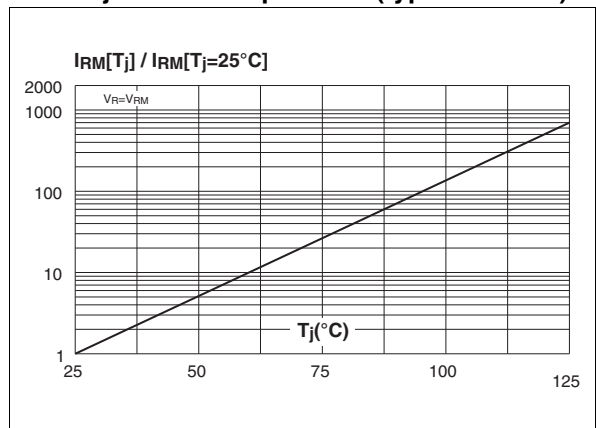


Figure 8: Variation of thermal impedance junction to ambient versus pulse duration (Printed circuit board FR4, SCu=35μm, recommended pad layout)

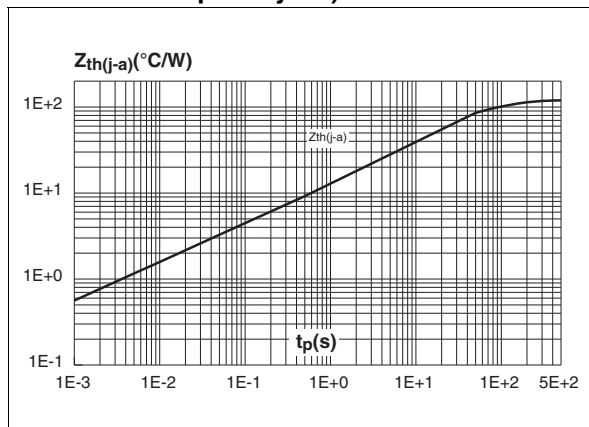


Figure 9: Relative variation of junction capacitance versus reverse voltage applied (typical values)

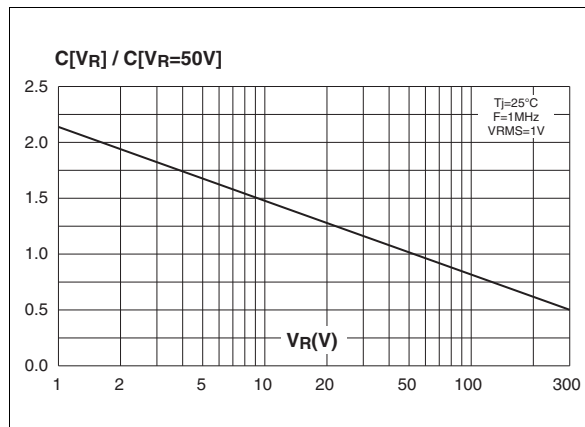


Figure 10: Test circuit 1 for dynamic I_{BO} and V_{BO} parameters

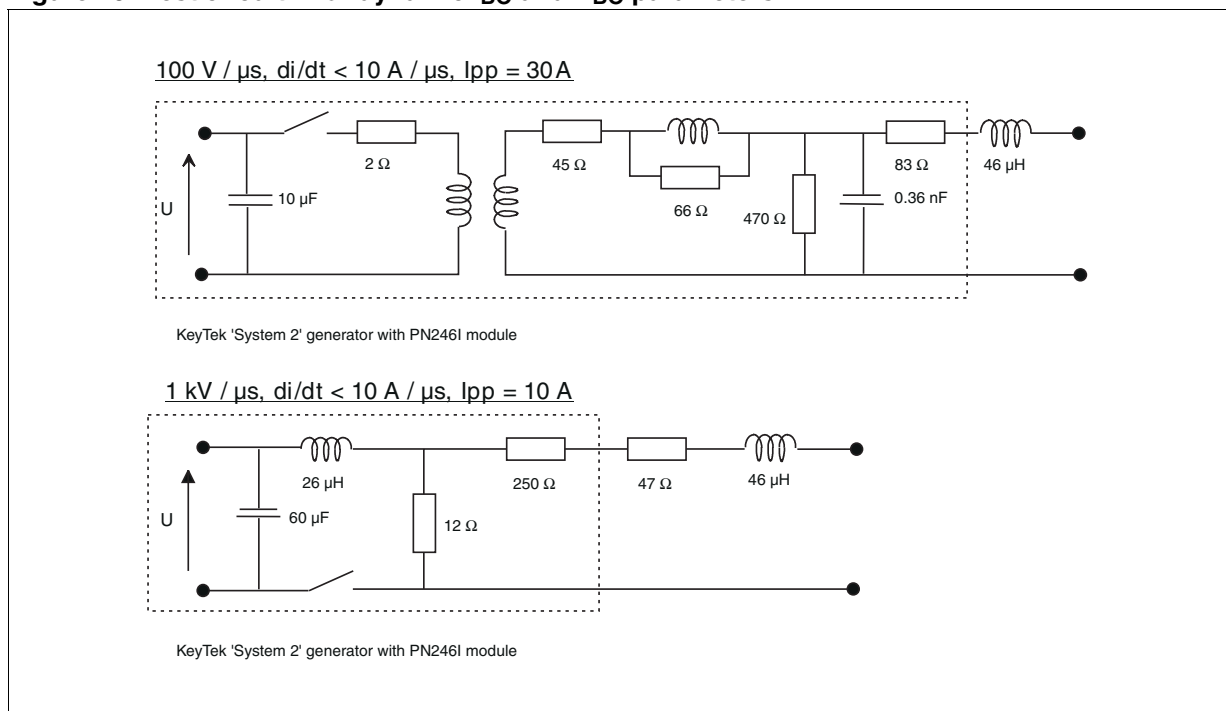


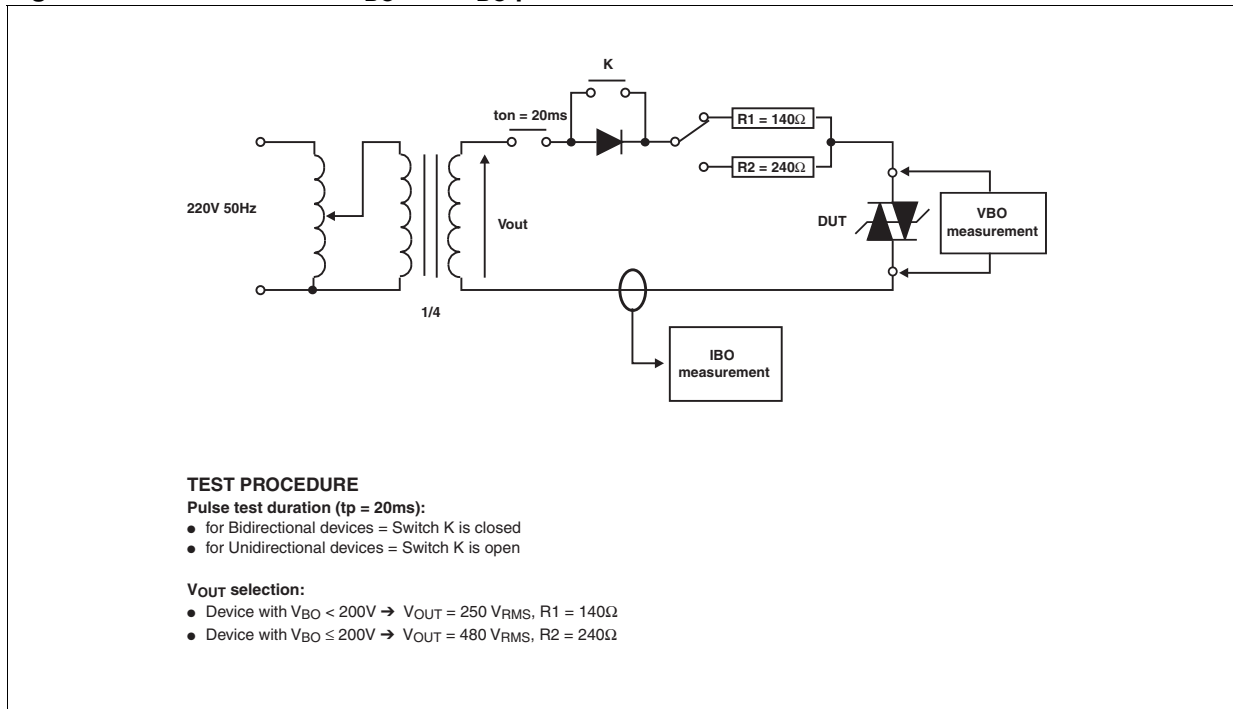
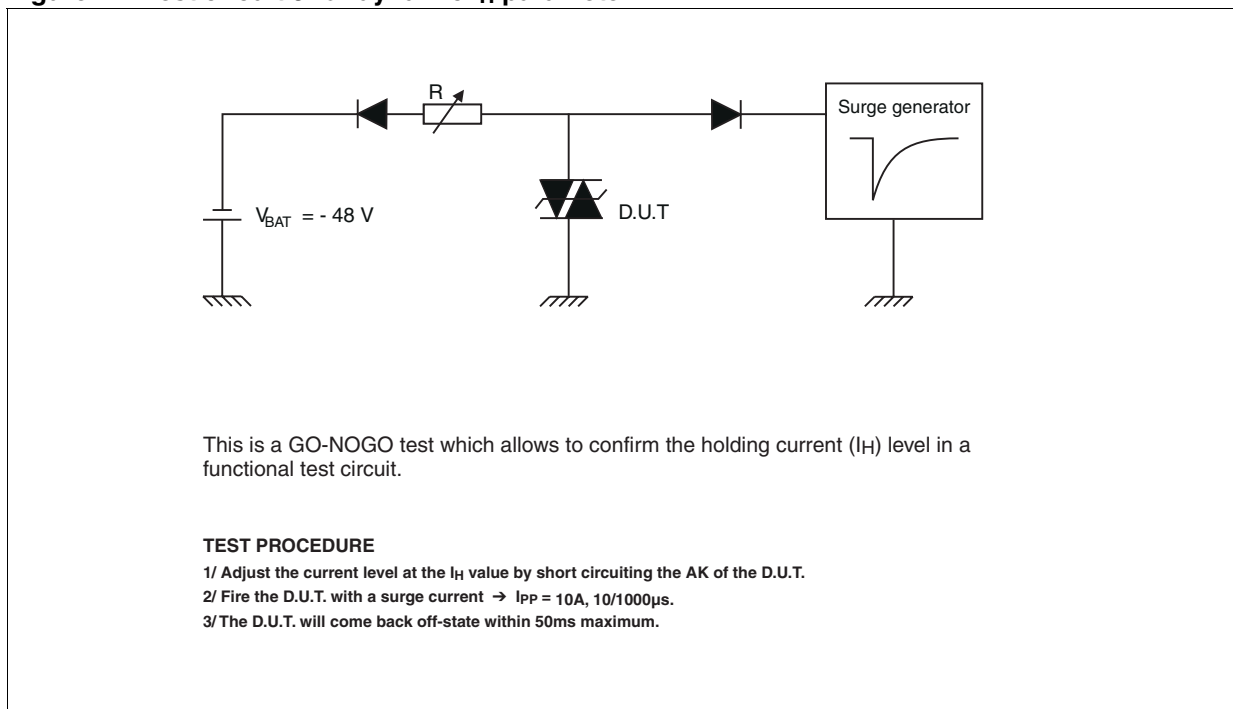
Figure 11: Test circuit 2 for I_{BO} and V_{BO} parametersFigure 12: Test circuit 3 for dynamic I_H parameter

Figure 13: Ordering Information Scheme

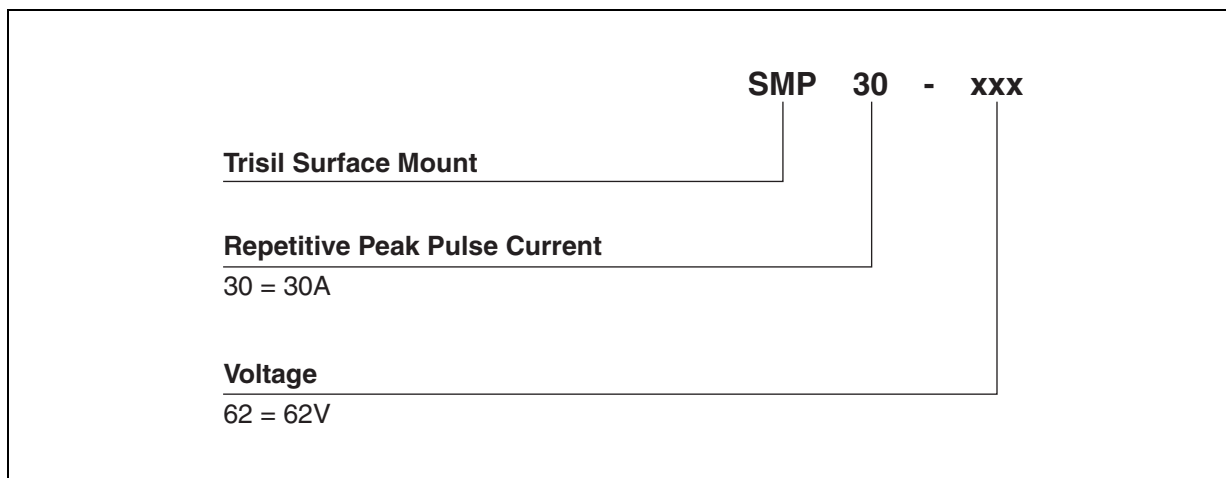


Figure 14: SMA Package Mechanical data

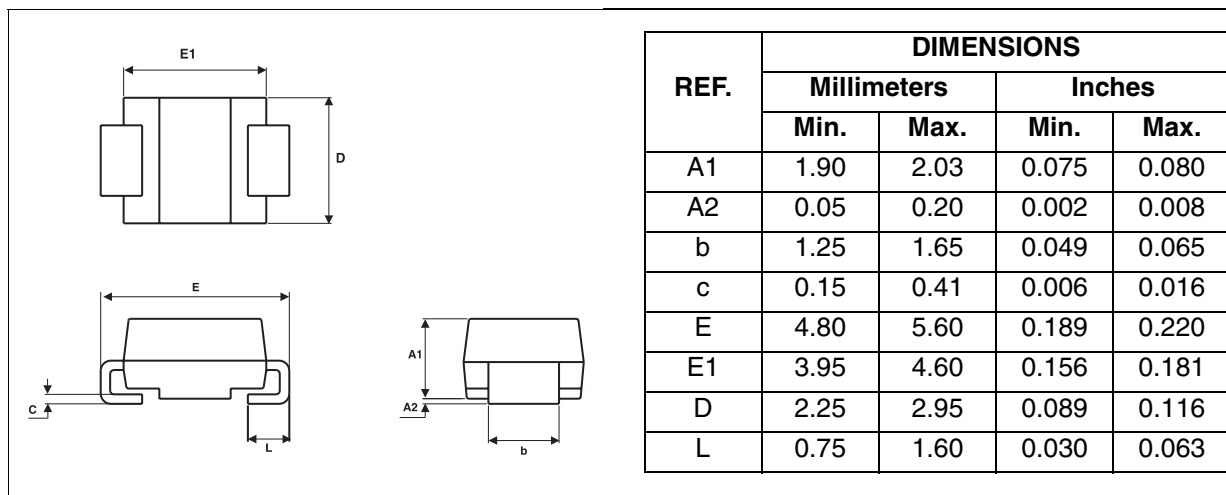
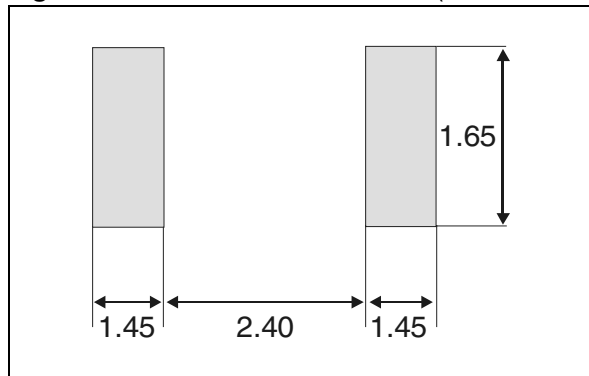


Figure 15: Foot Print Dimensions (in millimeters)



SMP30

Table 6: Ordering Information

Part Number	Marking	Package	Weight	Base qty	Delivery mode
SMP30-62	QAA	SMA	0.06 g	5000	Tape & reel
SMP30-68	QAB				
SMP30-100	QAC				
SMP30-120	QAD				
SMP30-130	QAE				
SMP30-180	QAF				
SMP30-200	QAG				
SMP30-220	QAH				
SMP30-240	QAI				
SMP30-270	QAJ				

Table 7: Revision History

Date	Revision	Description of Changes
November-2002	4B	Last update.
10-Nov-2004	5	SMA package dimensions update. Reference A1 max. changed from 2.70mm (0.106 inc.) to 2.03mm (0.080 inc.).
13-Dec-2004	6	Figure 7 text legend corrected from "... reverse voltage applied" to "... junction capacitance".

Information furnished is believed to be accurate and reliable. However, STMicroelectronics assumes no responsibility for the consequences of use of such information nor for any infringement of patents or other rights of third parties which may result from its use. No license is granted by implication or otherwise under any patent or patent rights of STMicroelectronics. Specifications mentioned in this publication are subject to change without notice. This publication supersedes and replaces all information previously supplied. STMicroelectronics products are not authorized for use as critical components in life support devices or systems without express written approval of STMicroelectronics.

The ST logo is a registered trademark of STMicroelectronics.
All other names are the property of their respective owners

© 2004 STMicroelectronics - All rights reserved

STMicroelectronics group of companies

Australia - Belgium - Brazil - Canada - China - Czech Republic - Finland - France - Germany - Hong Kong - India - Israel - Italy - Japan -
Malaysia - Malta - Morocco - Singapore - Spain - Sweden - Switzerland - United Kingdom - United States of America
www.st.com

