

# SN54CBT16212A, SN74CBT16212A 24-BIT FET BUS-EXCHANGE SWITCHES

SCDS007U – NOVEMBER 1992 – REVISED JUNE 2005

- Members of the Texas Instruments Widebus™ Family
- 5-Ω Switch Connection Between Two Ports
- TTL-Compatible Input Levels
- Latch-Up Performance Exceeds 250 mA Per JESD 17
- ESD Protection Exceeds JESD 22 – 200-V Machine Model (A115-A)

SN54CBT16212A . . . WD PACKAGE  
SN74CBT16212A . . . DGG, DGV, OR DL PACKAGE  
(TOP VIEW)

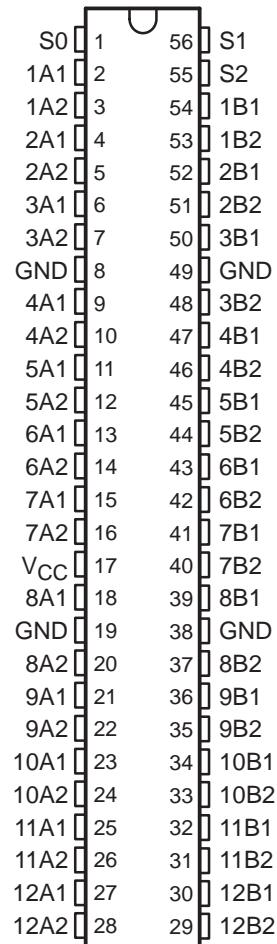

## description/ordering information

The 'CBT16212A devices provide 24 bits of high-speed TTL-compatible bus switching or exchanging. The low on-state resistance of the switch allows connections to be made with minimal propagation delay.

Each device operates as a 24-bit bus switch or a 12-bit bus exchanger that provides data exchanging between the four signal ports via the data-select (S0, S1, S2) terminals.

## ORDERING INFORMATION

T <sub>A</sub>	PACKAGE†		ORDERABLE PART NUMBER	TOP-SIDE MARKING
-40°C to 85°C	SSOP – DL	Tube	SN74CBT16212ADL	CBT16212A
		Tape and reel	SN74CBT16212ADLR	
	TSSOP – DGG	Tape and reel	SN74CBT16212ADGGR	CBT16212A
	TVSOP – DGV	Tape and reel	SN74CBT16212ADGVR	CY212A
	VFBGA – GQL	Tape and reel	SN74CBT16212AGQLR	CY212A
VFBGA – ZQL (Pb-free)			SN74CBT16212AZQLR	
-55°C to 125°C	CFP – WD	Tube	SNJ54CBT16212AWD	SNJ54CBT16212AWD

† Package drawings, standard packing quantities, thermal data, symbolization, and PCB design guidelines are available at [www.ti.com/sc/package](http://www.ti.com/sc/package).



Please be aware that an important notice concerning availability, standard warranty, and use in critical applications of Texas Instruments semiconductor products and disclaimers thereto appears at the end of this data sheet.

Widebus is a trademark of Texas Instruments.

PRODUCTION DATA information is current as of publication date. Products conform to specifications per the terms of Texas Instruments standard warranty. Production processing does not necessarily include testing of all parameters.



POST OFFICE BOX 655303 • DALLAS, TEXAS 75265

Copyright © 2005, Texas Instruments Incorporated  
On products compliant to MIL-PRF-38535, all parameters are tested unless otherwise noted. On all other products, production processing does not necessarily include testing of all parameters.

# SN54CBT16212A, SN74CBT16212A 24-BIT FET BUS-EXCHANGE SWITCHES

SCDS007U – NOVEMBER 1992 – REVISED JUNE 2005

GQL OR ZQL PACKAGE  
(TOP VIEW)

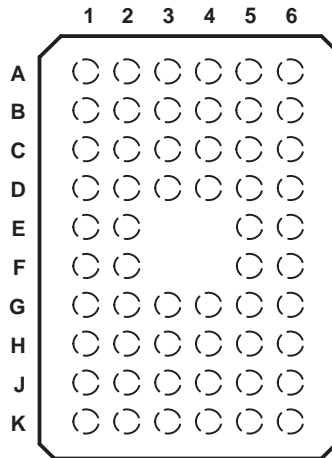

terminal assignments

	1	2	3	4	5	6
A	1A2	1A1	S0	S1	S2	1B1
B	3A1	2A2	2A1	1B2	2B1	2B2
C	4A1	GND	3A2	3B1	GND	3B2
D	5A2	4A2	5A1	4B2	4B1	5B1
E	6A2	6A1			5B2	6B1
F	7A1	7A2			7B1	6B2
G	VCC	GND	8A1	8B1	GND	7B2
H	8A2	9A1	9A2	9B2	9B1	8B2
J	10A1	10A2	11A1	11B1	10B2	10B1
K	11A2	12A1	12A2	12B2	12B1	11B2

FUNCTION TABLE

INPUTS			INPUTS/OUTPUTS		FUNCTION
S2	S1	S0	A1	A2	
L	L	L	Z	Z	Disconnect
L	L	H	B1 port	Z	A1 port = B1 port
L	H	L	B2 port	Z	A1 port = B2 port
L	H	H	Z	B1 port	A2 port = B1 port
H	L	L	Z	B2 port	A2 port = B2 port
H	L	H	Z	Z	Disconnect
H	H	L	B1 port	B2 port	A1 port = B1 port A2 port = B2 port
H	H	H	B2 port	B1 port	A1 port = B2 port A2 port = B1 port

# SN54CBT16212A, SN74CBT16212A 24-BIT FET BUS-EXCHANGE SWITCHES

SCDS007U – NOVEMBER 1992 – REVISED JUNE 2005

## logic diagram (positive logic)

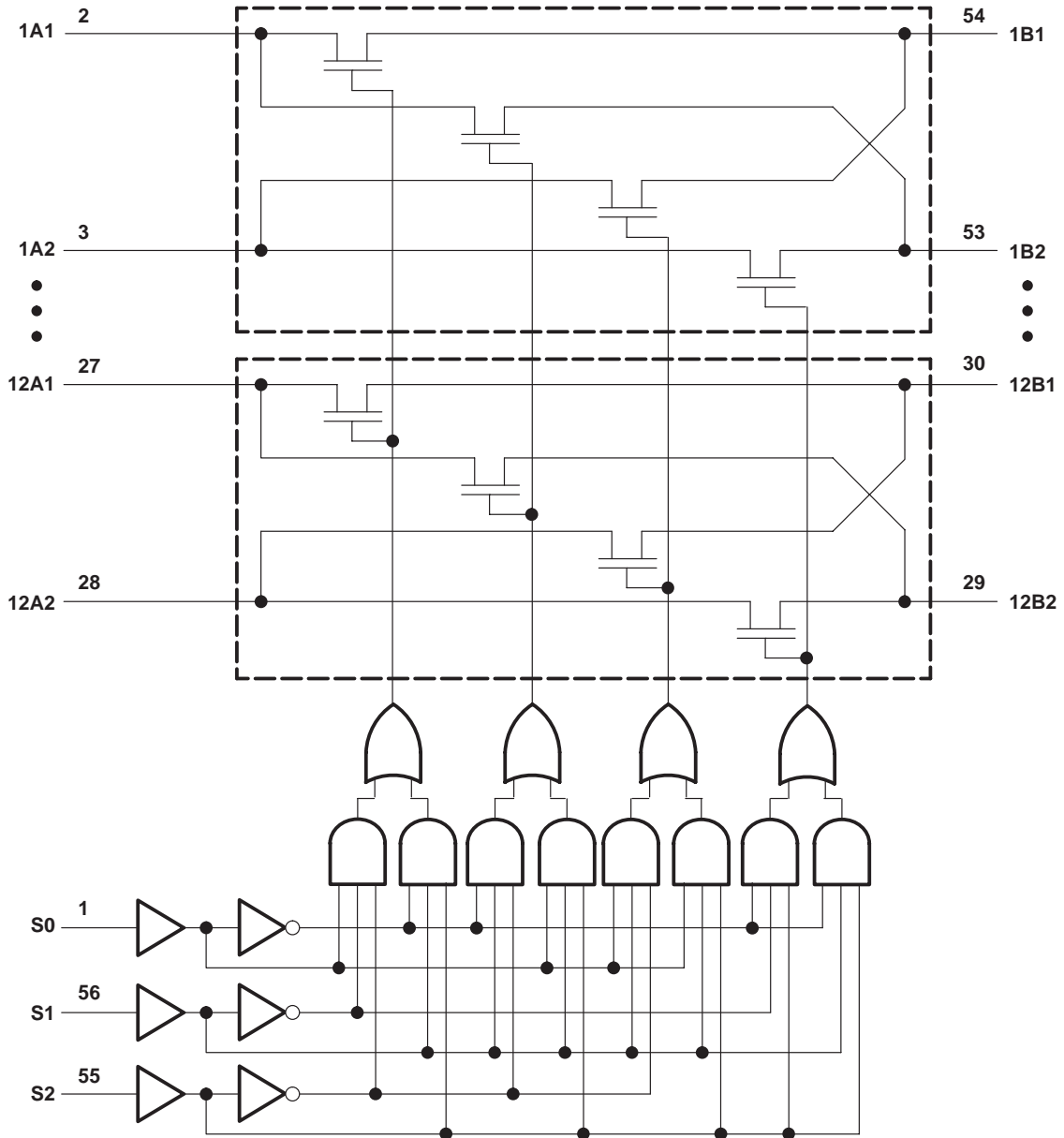

Pin numbers shown are for the DGG, DGV, DL, and WD packages.

# SN54CBT16212A, SN74CBT16212A 24-BIT FET BUS-EXCHANGE SWITCHES

SCDS007U – NOVEMBER 1992 – REVISED JUNE 2005

## absolute maximum ratings over operating free-air temperature range (unless otherwise noted)†

Supply voltage range, $V_{CC}$	–0.5 V to 7 V
Input voltage range, $V_I$ (see Note 1)	–0.5 V to 7 V
Continuous channel current	128 mA
Input clamp current, $I_{IK}$ ( $V_I < 0$ )	–50 mA
Package thermal impedance, $\theta_{JA}$ (see Note 2): DGG package	64°C/W
DGV package	48°C/W
DL package	56°C/W
GQL/ZQL package	42°C/W
Storage temperature range, $T_{stg}$	–65°C to 150°C

† Stresses beyond those listed under “absolute maximum ratings” may cause permanent damage to the device. These are stress ratings only, and functional operation of the device at these or any other conditions beyond those indicated under “recommended operating conditions” is not implied. Exposure to absolute-maximum-rated conditions for extended periods may affect device reliability.

- NOTES: 1. The input and output negative-voltage ratings may be exceeded if the input and output clamp-current ratings are observed.  
2. The package thermal impedance is calculated in accordance with JESD 51-7.

## recommended operating conditions (see Note 3)

	SN54CBT16212A		SN74CBT16212A		UNIT
	MIN	MAX	MIN	MAX	
$V_{CC}$ Supply voltage	4	5.5	4	5.5	V
$V_{IH}$ High-level control input voltage	2		2		V
$V_{IL}$ Low-level control input voltage		0.8		0.8	V
$T_A$ Operating free-air temperature	–55	125	–40	85	°C

NOTE 3: All unused control inputs of the device must be held at  $V_{CC}$  or GND to ensure proper device operation. Refer to the TI application report, *Implications of Slow or Floating CMOS Inputs*, literature number SCBA004.

## electrical characteristics over recommended operating free-air temperature range (unless otherwise noted)

PARAMETER	TEST CONDITIONS	SN54CBT16212A		SN74CBT16212A		UNIT		
		MIN	TYP‡	MAX	MIN		TYP‡	MAX
$V_{IK}$	$V_{CC} = 4.5$ V, $I_I = -18$ mA			–1.2		–1.2	V	
$I_I$	$V_{CC} = 0$ , $V_I = 5.5$ V			10		10	μA	
	$V_{CC} = 5.5$ V, $V_I = 5.5$ V or GND			±1		±1		
$I_{CC}$	$V_{CC} = 5.5$ V, $I_O = 0$ , $V_I = V_{CC}$ or GND			3.2		3	μA	
$\Delta I_{CC}$ §	Control inputs $V_{CC} = 5.5$ V, One input at 3.4 V, Other inputs at $V_{CC}$ or GND			2.5		2.5	mA	
$C_i$	Control inputs $V_I = 3$ V or 0			2.5		2.5	pF	
$C_{io(off)}$	$V_O = 3$ V or 0, $S_0, S_1,$ and $S_2 =$ GND			7.5		7.5	pF	
$r_{on}$ ¶	$V_{CC} = 4$ V, TYP at $V_{CC} = 4$ V	$V_I = 2.4$ V,	$I_I = 15$ mA	14	20	14	20	Ω
	$V_{CC} = 4.5$ V	$V_I = 0$	$I_I = 64$ mA	4	10	4	7	
			$I_I = 30$ mA	4	10	4	7	
		$V_I = 2.4$ V,	$I_I = 15$ mA	6	14	6	12	

‡ All typical values are at  $V_{CC} = 5$  V (unless otherwise noted),  $T_A = 25^\circ\text{C}$ .

§ This is the increase in supply current for each input that is at the specified TTL voltage level, rather than  $V_{CC}$  or GND.

¶ Measured by the voltage drop between the A and B terminals at the indicated current through the switch. On-state resistance is determined by the lower of the voltages of the two (A or B) terminals.



# SN54CBT16212A, SN74CBT16212A 24-BIT FET BUS-EXCHANGE SWITCHES

SCDS007U – NOVEMBER 1992 – REVISED JUNE 2005

switching characteristics over recommended operating free-air temperature range,  $C_L = 50$  pF (unless otherwise noted) (see Figure 1)

PARAMETER	FROM (INPUT)	TO (OUTPUT)	SN54CBT16212A				SN74CBT16212A				UNIT
			$V_{CC} = 4$ V		$V_{CC} = 5$ V $\pm 0.5$ V		$V_{CC} = 4$ V		$V_{CC} = 5$ V $\pm 0.5$ V		
			MIN	MAX	MIN	MAX	MIN	MAX	MIN	MAX	
$t_{pd}^\dagger$	A or B	B or A				0.8*		0.35		0.25	ns
$t_{pd}$	S	A or B		14	1.5	13		10	1.5	9.1	ns
$t_{en}$	S	A or B		15	1.5	13.7		10.4	1.5	9.7	ns
$t_{dis}$	S	A or B		14.2	1.5	13.5		9.2	1.5	8.8	ns

\* On products compliant to MIL-PRF-38535, this parameter is not production tested.

† The propagation delay is the calculated RC time constant of the typical on-state resistance of the switch and the specified load capacitance, when driven by an ideal voltage source (zero output impedance).

## PARAMETER MEASUREMENT INFORMATION

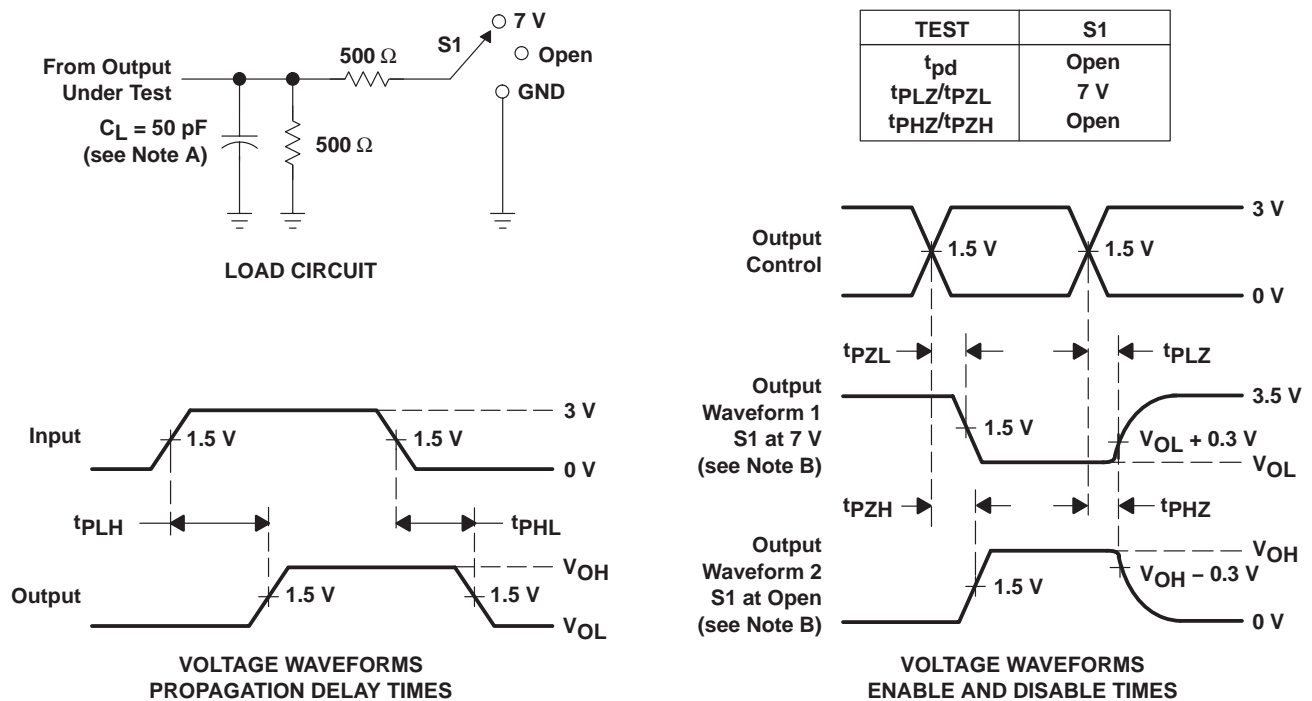

- NOTES:
- $C_L$  includes probe and jig capacitance.
  - Waveform 1 is for an output with internal conditions such that the output is low, except when disabled by the output control. Waveform 2 is for an output with internal conditions such that the output is high, except when disabled by the output control.
  - All input pulses are supplied by generators having the following characteristics: PRR  $\leq 10$  MHz,  $Z_O = 50$   $\Omega$ ,  $t_r \leq 2.5$  ns,  $t_f \leq 2.5$  ns.
  - The outputs are measured one at a time, with one transition per measurement.
  - $t_{PLZ}$  and  $t_{PHZ}$  are the same as  $t_{dis}$ .
  - $t_{PZL}$  and  $t_{PZH}$  are the same as  $t_{en}$ .
  - $t_{PLH}$  and  $t_{PHL}$  are the same as  $t_{pd}$ .
  - All parameters and waveforms are not applicable to all devices.

Figure 1. Load Circuit and Voltage Waveforms

**PACKAGING INFORMATION**

Orderable Device	Status <sup>(1)</sup>	Package Type	Package Drawing	Pins	Package Qty	Eco Plan <sup>(2)</sup>	Lead/Ball Finish	MSL Peak Temp <sup>(3)</sup>
5962-9852101QXA	ACTIVE	CFP	WD	56	1	TBD	A42	N / A for Pkg Type
74CBT16212ADGGRE4	ACTIVE	TSSOP	DGG	56	2000	Green (RoHS & no Sb/Br)	CU NIPDAU	Level-1-260C-UNLIM
74CBT16212ADGGRG4	ACTIVE	TSSOP	DGG	56	2000	Green (RoHS & no Sb/Br)	CU NIPDAU	Level-1-260C-UNLIM
74CBT16212ADGVRE4	ACTIVE	TVSOP	DGV	56	2000	Green (RoHS & no Sb/Br)	CU NIPDAU	Level-1-260C-UNLIM
74CBT16212ADGVRG4	ACTIVE	TVSOP	DGV	56	2000	Green (RoHS & no Sb/Br)	CU NIPDAU	Level-1-260C-UNLIM
SN74CBT16212ADGGR	ACTIVE	TSSOP	DGG	56	2000	Green (RoHS & no Sb/Br)	CU NIPDAU	Level-1-260C-UNLIM
SN74CBT16212ADGVR	ACTIVE	TVSOP	DGV	56	2000	Green (RoHS & no Sb/Br)	CU NIPDAU	Level-1-260C-UNLIM
SN74CBT16212ADL	ACTIVE	SSOP	DL	56	20	Green (RoHS & no Sb/Br)	CU NIPDAU	Level-1-260C-UNLIM
SN74CBT16212ADLG4	ACTIVE	SSOP	DL	56	20	Green (RoHS & no Sb/Br)	CU NIPDAU	Level-1-260C-UNLIM
SN74CBT16212ADLR	ACTIVE	SSOP	DL	56	1000	Green (RoHS & no Sb/Br)	CU NIPDAU	Level-1-260C-UNLIM
SN74CBT16212ADLRG4	ACTIVE	SSOP	DL	56	1000	Green (RoHS & no Sb/Br)	CU NIPDAU	Level-1-260C-UNLIM
SN74CBT16212AGQLR	NRND	BGA MICROSTAR JUNIOR	GQL	56	1000	TBD	SNPB	Level-1-240C-UNLIM
SN74CBT16212AZQLR	ACTIVE	BGA MICROSTAR JUNIOR	ZQL	56	1000	Green (RoHS & no Sb/Br)	SNAGCU	Level-1-260C-UNLIM
SNJ54CBT16212AWD	ACTIVE	CFP	WD	56	1	TBD	A42	N / A for Pkg Type

<sup>(1)</sup> The marketing status values are defined as follows:

**ACTIVE:** Product device recommended for new designs.

**LIFEBUY:** TI has announced that the device will be discontinued, and a lifetime-buy period is in effect.

**NRND:** Not recommended for new designs. Device is in production to support existing customers, but TI does not recommend using this part in a new design.

**PREVIEW:** Device has been announced but is not in production. Samples may or may not be available.

**OBsolete:** TI has discontinued the production of the device.

<sup>(2)</sup> Eco Plan - The planned eco-friendly classification: Pb-Free (RoHS), Pb-Free (RoHS Exempt), or Green (RoHS & no Sb/Br) - please check <http://www.ti.com/productcontent> for the latest availability information and additional product content details.

**TBD:** The Pb-Free/Green conversion plan has not been defined.

**Pb-Free (RoHS):** TI's terms "Lead-Free" or "Pb-Free" mean semiconductor products that are compatible with the current RoHS requirements for all 6 substances, including the requirement that lead not exceed 0.1% by weight in homogeneous materials. Where designed to be soldered at high temperatures, TI Pb-Free products are suitable for use in specified lead-free processes.

**Pb-Free (RoHS Exempt):** This component has a RoHS exemption for either 1) lead-based flip-chip solder bumps used between the die and package, or 2) lead-based die adhesive used between the die and leadframe. The component is otherwise considered Pb-Free (RoHS compatible) as defined above.

**Green (RoHS & no Sb/Br):** TI defines "Green" to mean Pb-Free (RoHS compatible), and free of Bromine (Br) and Antimony (Sb) based flame retardants (Br or Sb do not exceed 0.1% by weight in homogeneous material)

<sup>(3)</sup> MSL, Peak Temp. -- The Moisture Sensitivity Level rating according to the JEDEC industry standard classifications, and peak solder temperature.

**Important Information and Disclaimer:**The information provided on this page represents TI's knowledge and belief as of the date that it is provided. TI bases its knowledge and belief on information provided by third parties, and makes no representation or warranty as to the accuracy of such information. Efforts are underway to better integrate information from third parties. TI has taken and continues to take reasonable steps to provide representative and accurate information but may not have conducted destructive testing or chemical analysis on incoming materials and chemicals. TI and TI suppliers consider certain information to be proprietary, and thus CAS numbers and other limited information may not be available for release.

In no event shall TI's liability arising out of such information exceed the total purchase price of the TI part(s) at issue in this document sold by TI to Customer on an annual basis.

**TAPE AND REEL INFORMATION**



**QUADRANT ASSIGNMENTS FOR PIN 1 ORIENTATION IN TAPE**



\*All dimensions are nominal

Device	Package Type	Package Drawing	Pins	SPQ	Reel Diameter (mm)	Reel Width W1 (mm)	A0 (mm)	B0 (mm)	K0 (mm)	P1 (mm)	W (mm)	Pin1 Quadrant
SN74CBT16212ADGGR	TSSOP	DGG	56	2000	330.0	24.4	8.6	15.6	1.8	12.0	24.0	Q1
SN74CBT16212ADGVR	TVSOP	DGV	56	2000	330.0	24.4	6.8	11.7	1.6	12.0	24.0	Q1
SN74CBT16212ADLR	SSOP	DL	56	1000	330.0	32.4	11.35	18.67	3.1	16.0	32.0	Q1
SN74CBT16212AGQLR	BGA MICROSTAR JUNIOR	GQL	56	1000	330.0	16.4	4.8	7.3	1.45	8.0	16.0	Q1
SN74CBT16212AZQLR	BGA MICROSTAR JUNIOR	ZQL	56	1000	330.0	16.4	4.8	7.3	1.45	8.0	16.0	Q1



**TAPE AND REEL BOX DIMENSIONS**



\*All dimensions are nominal

Device	Package Type	Package Drawing	Pins	SPQ	Length (mm)	Width (mm)	Height (mm)
SN74CBT16212ADGGR	TSSOP	DGG	56	2000	346.0	346.0	41.0
SN74CBT16212ADGVR	TVSOP	DGV	56	2000	346.0	346.0	41.0
SN74CBT16212ADLR	SSOP	DL	56	1000	346.0	346.0	49.0
SN74CBT16212AGQLR	BGA MICROSTAR JUNIOR	GQL	56	1000	346.0	346.0	33.0
SN74CBT16212AZQLR	BGA MICROSTAR JUNIOR	ZQL	56	1000	346.0	346.0	33.0

ZQL (R-PBGA-N56)

PLASTIC BALL GRID ARRAY

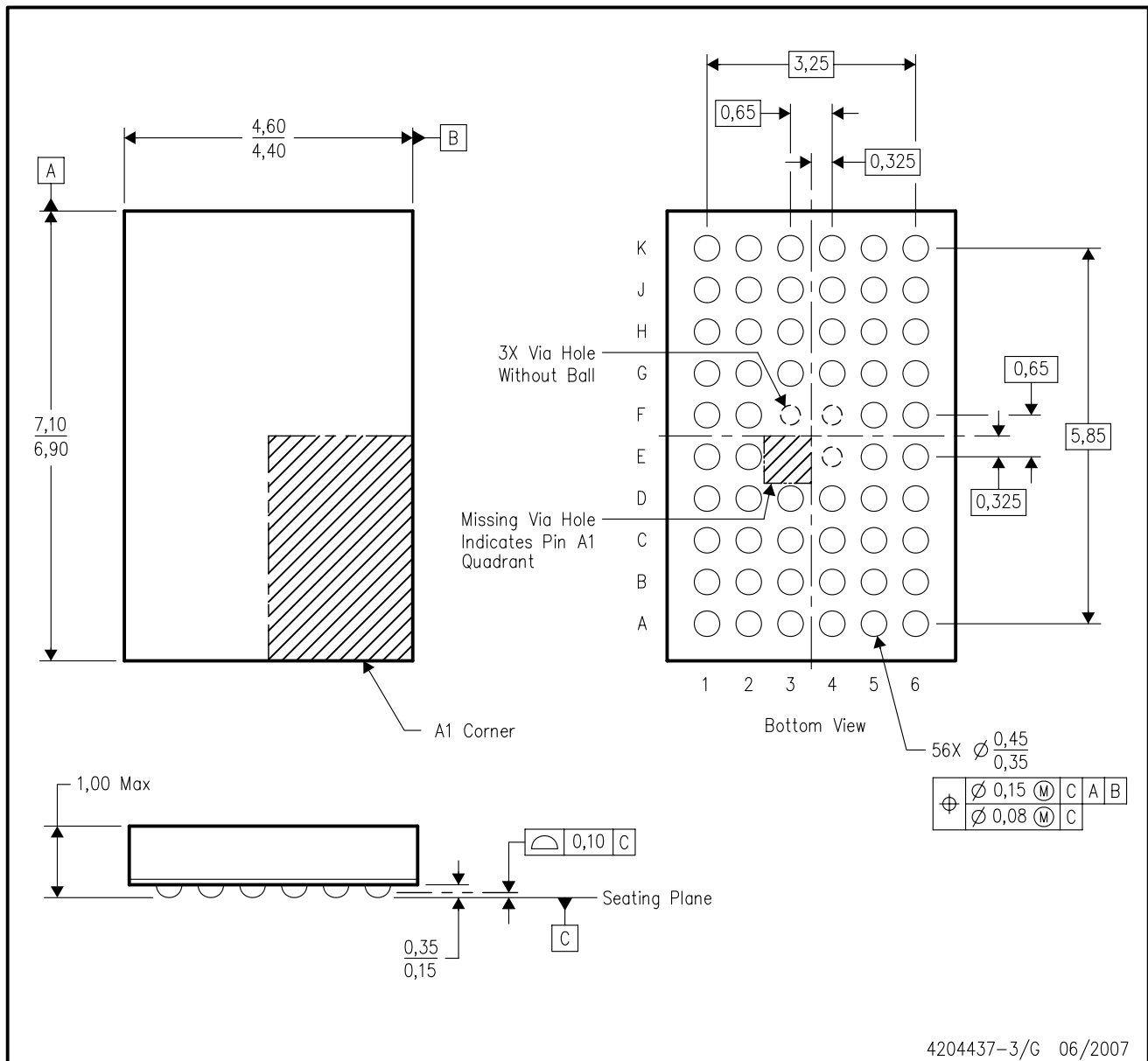

- NOTES:
- A. All linear dimensions are in millimeters. Dimensioning and tolerancing per ASME Y14.5M-1994.
  - B. This drawing is subject to change without notice.
  - C. Falls within JEDEC MO-285 variation BA-2.
  - D. This package is lead-free. Refer to the 56 GQL package (drawing 4200583) for tin-lead (SnPb).

GQL (R-PBGA-N56)

PLASTIC BALL GRID ARRAY

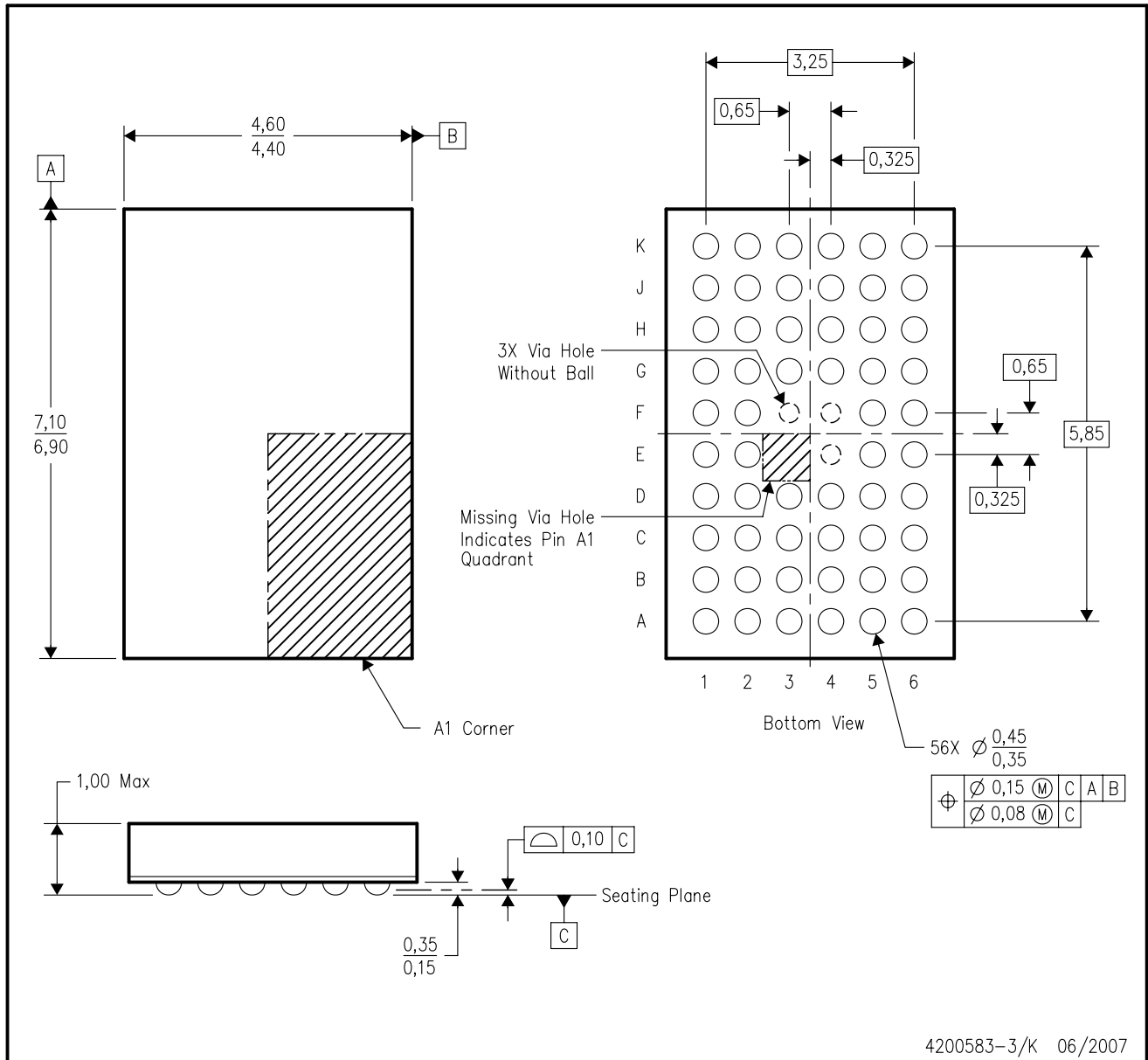

- NOTES:
- A. All linear dimensions are in millimeters. Dimensioning and tolerancing per ASME Y14.5M-1994.
  - B. This drawing is subject to change without notice.
  - C. Falls within JEDEC MO-285 variation BA-2.
  - D. This package is tin-lead (SnPb). Refer to the 56 ZQL package (drawing 4204437) for lead-free.

DGG (R-PDSO-G\*\*)

PLASTIC SMALL-OUTLINE PACKAGE

48 PINS SHOWN



- NOTES: A. All linear dimensions are in millimeters.  
 B. This drawing is subject to change without notice.  
 C. Body dimensions do not include mold protrusion not to exceed 0,15.  
 D. Falls within JEDEC MO-153

DL (R-PDSO-G\*\*)

PLASTIC SMALL-OUTLINE PACKAGE

48 PINS SHOWN



- NOTES: A. All linear dimensions are in inches (millimeters).  
 B. This drawing is subject to change without notice.  
 C. Body dimensions do not include mold flash or protrusion not to exceed 0.006 (0,15).  
 D. Falls within JEDEC MO-118

DGV (R-PDSO-G\*\*)

PLASTIC SMALL-OUTLINE

24 PINS SHOWN



- NOTES: A. All linear dimensions are in millimeters.  
 B. This drawing is subject to change without notice.  
 C. Body dimensions do not include mold flash or protrusion, not to exceed 0,15 per side.  
 D. Falls within JEDEC: 24/48 Pins – MO-153  
 14/16/20/56 Pins – MO-194

WD (R-GDFP-F\*\*)

CERAMIC DUAL FLATPACK

48 LEADS SHOWN

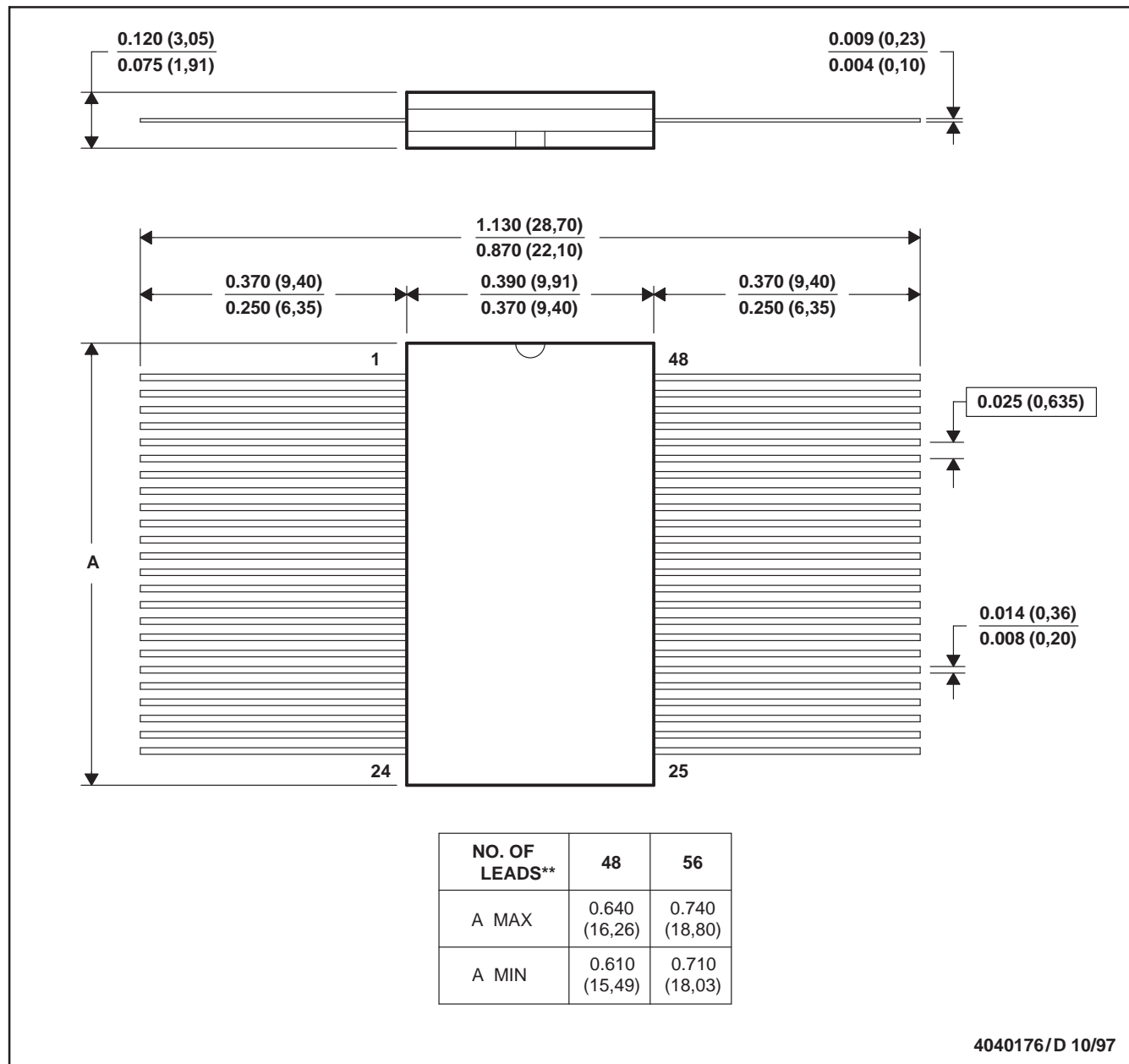

- NOTES: A. All linear dimensions are in inches (millimeters).  
 B. This drawing is subject to change without notice.  
 C. This package can be hermetically sealed with a ceramic lid using glass frit.  
 D. Index point is provided on cap for terminal identification only  
 E. Falls within MIL STD 1835: GDFP1-F48 and JEDEC MO-146AA  
 GDFP1-F56 and JEDEC MO-146AB

## IMPORTANT NOTICE

Texas Instruments Incorporated and its subsidiaries (TI) reserve the right to make corrections, modifications, enhancements, improvements, and other changes to its products and services at any time and to discontinue any product or service without notice. Customers should obtain the latest relevant information before placing orders and should verify that such information is current and complete. All products are sold subject to TI's terms and conditions of sale supplied at the time of order acknowledgment.

TI warrants performance of its hardware products to the specifications applicable at the time of sale in accordance with TI's standard warranty. Testing and other quality control techniques are used to the extent TI deems necessary to support this warranty. Except where mandated by government requirements, testing of all parameters of each product is not necessarily performed.

TI assumes no liability for applications assistance or customer product design. Customers are responsible for their products and applications using TI components. To minimize the risks associated with customer products and applications, customers should provide adequate design and operating safeguards.

TI does not warrant or represent that any license, either express or implied, is granted under any TI patent right, copyright, mask work right, or other TI intellectual property right relating to any combination, machine, or process in which TI products or services are used. Information published by TI regarding third-party products or services does not constitute a license from TI to use such products or services or a warranty or endorsement thereof. Use of such information may require a license from a third party under the patents or other intellectual property of the third party, or a license from TI under the patents or other intellectual property of TI.

Reproduction of TI information in TI data books or data sheets is permissible only if reproduction is without alteration and is accompanied by all associated warranties, conditions, limitations, and notices. Reproduction of this information with alteration is an unfair and deceptive business practice. TI is not responsible or liable for such altered documentation. Information of third parties may be subject to additional restrictions.

Resale of TI products or services with statements different from or beyond the parameters stated by TI for that product or service voids all express and any implied warranties for the associated TI product or service and is an unfair and deceptive business practice. TI is not responsible or liable for any such statements.

TI products are not authorized for use in safety-critical applications (such as life support) where a failure of the TI product would reasonably be expected to cause severe personal injury or death, unless officers of the parties have executed an agreement specifically governing such use. Buyers represent that they have all necessary expertise in the safety and regulatory ramifications of their applications, and acknowledge and agree that they are solely responsible for all legal, regulatory and safety-related requirements concerning their products and any use of TI products in such safety-critical applications, notwithstanding any applications-related information or support that may be provided by TI. Further, Buyers must fully indemnify TI and its representatives against any damages arising out of the use of TI products in such safety-critical applications.

TI products are neither designed nor intended for use in military/aerospace applications or environments unless the TI products are specifically designated by TI as military-grade or "enhanced plastic." Only products designated by TI as military-grade meet military specifications. Buyers acknowledge and agree that any such use of TI products which TI has not designated as military-grade is solely at the Buyer's risk, and that they are solely responsible for compliance with all legal and regulatory requirements in connection with such use.

TI products are neither designed nor intended for use in automotive applications or environments unless the specific TI products are designated by TI as compliant with ISO/TS 16949 requirements. Buyers acknowledge and agree that, if they use any non-designated products in automotive applications, TI will not be responsible for any failure to meet such requirements.

Following are URLs where you can obtain information on other Texas Instruments products and application solutions:

### Products

Amplifiers	<a href="http://amplifier.ti.com">amplifier.ti.com</a>
Data Converters	<a href="http://dataconverter.ti.com">dataconverter.ti.com</a>
DLP® Products	<a href="http://www.dlp.com">www.dlp.com</a>
DSP	<a href="http://dsp.ti.com">dsp.ti.com</a>
Clocks and Timers	<a href="http://www.ti.com/clocks">www.ti.com/clocks</a>
Interface	<a href="http://interface.ti.com">interface.ti.com</a>
Logic	<a href="http://logic.ti.com">logic.ti.com</a>
Power Mgmt	<a href="http://power.ti.com">power.ti.com</a>
Microcontrollers	<a href="http://microcontroller.ti.com">microcontroller.ti.com</a>
RFID	<a href="http://www.ti-rfid.com">www.ti-rfid.com</a>
RF/IF and ZigBee® Solutions	<a href="http://www.ti.com/lprf">www.ti.com/lprf</a>

### Applications

Audio	<a href="http://www.ti.com/audio">www.ti.com/audio</a>
Automotive	<a href="http://www.ti.com/automotive">www.ti.com/automotive</a>
Broadband	<a href="http://www.ti.com/broadband">www.ti.com/broadband</a>
Digital Control	<a href="http://www.ti.com/digitalcontrol">www.ti.com/digitalcontrol</a>
Medical	<a href="http://www.ti.com/medical">www.ti.com/medical</a>
Military	<a href="http://www.ti.com/military">www.ti.com/military</a>
Optical Networking	<a href="http://www.ti.com/opticalnetwork">www.ti.com/opticalnetwork</a>
Security	<a href="http://www.ti.com/security">www.ti.com/security</a>
Telephony	<a href="http://www.ti.com/telephony">www.ti.com/telephony</a>
Video & Imaging	<a href="http://www.ti.com/video">www.ti.com/video</a>
Wireless	<a href="http://www.ti.com/wireless">www.ti.com/wireless</a>

Mailing Address: Texas Instruments, Post Office Box 655303, Dallas, Texas 75265  
Copyright © 2009, Texas Instruments Incorporated