

With fuseholder 5x20 mm, with or without voltage selector (step switch)

Plug removal necessary for fuse replacement



Screw-on mounting  
from front side  
with voltage selector



Screw-on mounting  
from rear side  
without voltage selector



Screw-on mounting  
from front side  
without voltage selector

C14



70° C



### Description

- Panel Mount:
- Screw-on version from front or rear side, snap-in version from front side
- 4 Functions:  
Inlet Protection class I, Fuseholder for fuse-links 5 x 20 mm 1- or 2-pole, with or without voltage selector (step switch), Line filter in standard and medical version
- Quick connect terminals or wires
- Alternative: version without line filter KEA

### Approvals

- VDE License Number: 40004665
- UL License Number: E76360

### Characteristics

- Rear side mounting for efficient cost-saving assembly
- Suitable for assembly in metal plated plastic housings
- All single elements are already wired
- Plug removal necessary for fuse-link replacement
- The fuse drawer "Fingergrip" can be removed by hand
- For added safety "Extra-Safe" fuse drawers are available
- Fuse drawer meets requirements of medical standard IEC/EN 60601-1
- The fuseholder is accessible from the equipment front
- Qualified for use in equipment according IEC/EN 60950

### Other versions on request

- Capacity CX 100 nF

### References

General Product Information see page 282

### Weblinks

Approvals:  
RoHS:

### Technical Data

Ratings IEC	1 - 10 A @ Ta 40 °C / 250 VAC; 50 Hz
Ratings UL/CSA	1 - 10 A @ Ta 40 °C / 125 VAC; 60 Hz
Leakage Current	standard < 0.5 mA (250 V / 60 Hz) medical < 5 µA (250 V / 60 Hz)
Dielectric Strength	> 1.7 kVDC between L-N > 2.7 kVDC between L/N-PE Test voltage (2 sec)
Allowable Operation Temp.	-25 °C to 85 °C
Climatic Category	25/085/21 acc. to IEC 60068-1
Degree of Protection	from front side IP 40 acc. to IEC 60529
Protection Class	Suitable for appliances with protection class I acc. to IEC 61140
Terminals	Quick connect terminals or wires
Panel Thickness s	Screw-on: max 8 mm Mounting screw torque max 0.5 Nm Snap-in: 0.8 mm to 3 mm
Material: Housing	Thermoplastic, Black, UL 94V-0

Appliance-Inlet /-Outlet	C14 acc. to IEC/EN 60320-1, UL 498, CSA C22.2 no. 42 (for cold condition) pin-temperature 70 °C, 10 A, Protection class I
Fuseholder	1- or 2-pole, Shocksafe category PC2 acc. to IEC 60127-6, for fuse-links 5 x 20 mm
Rated Power Acceptance @ Ta 23 °C	5 x 20: 2 W (1-pole)/ 1.6 W (2-pole) per pole
Power Acceptance @ Ta > 23°C	Admissible power acceptance at higher ambient temperature see derating curves
Voltage selector	optional, step, 3 digits
Line Filter	Standard and Medical Version, IEC 60939, IEC 60601-1, UL 1283, UL 544, EN 133 200, CSA C22.2 no. 8 Technical details see WEBXXX
MTBF	> 1'700'000 h acc. to MIL-HB-217 F

Dimensions

Screw-on mounting from front side

Length |-----| 69 mm

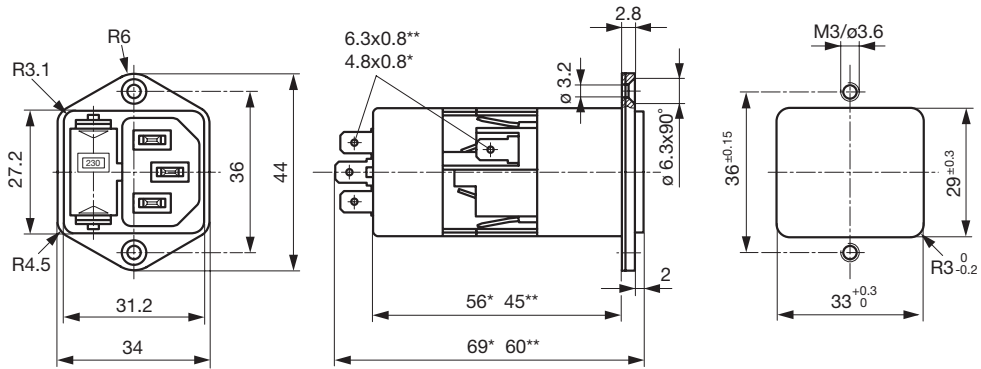

\* with voltage selector

\*\* without voltage selector

Screw-on mounting from rear side

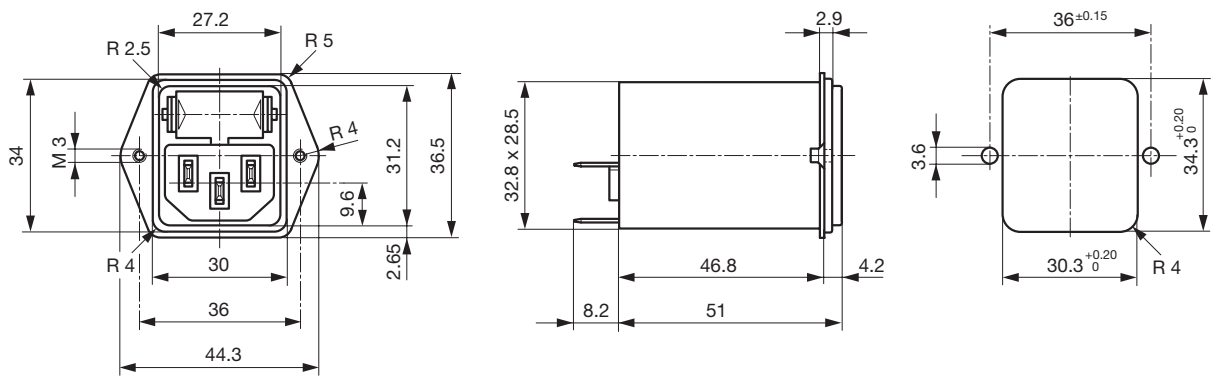

Snap-in mounting

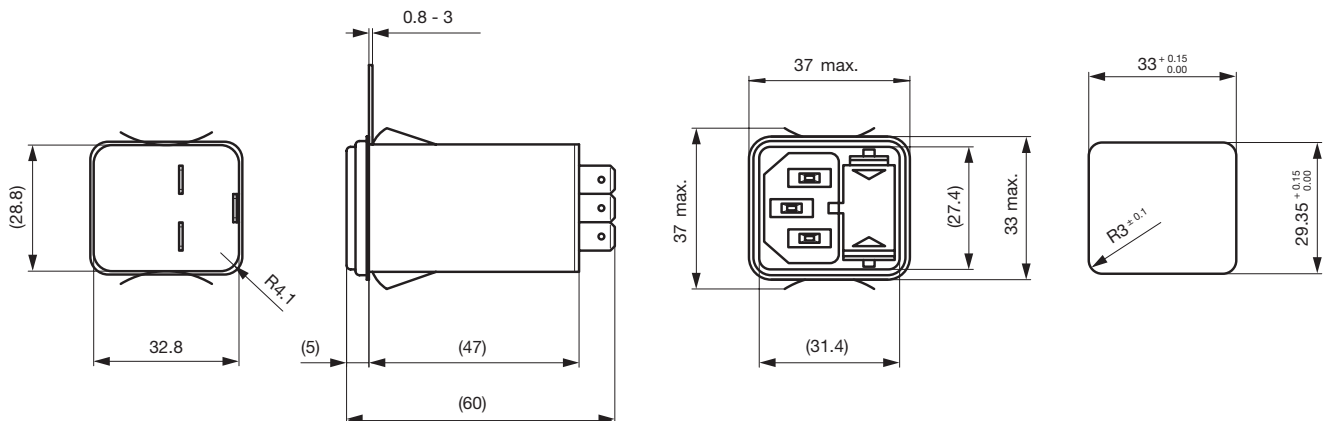

Technical Data of Filter-Components

Rated Current [A]	Filter-Type	Inductances	Capacitance	Capacitance	R [MΩ]
		L [mH]	CX [nF]	CY [nF]	
1	Standard Version	2 x 10	68	2.2	
2	Standard Version	2 x 4	68	2.2	
4	Standard Version	2 x 1.5	68	2.2	
6	Standard Version	2 x 0.8	68	2.2	
10	Standard Version	2 x 0.3	68	2.2	
1	Medical Version (M5)	2 x 10	68		1
2	Medical Version (M5)	2 x 4	68		1
2	Medical Version (M5)	2 x 4	68	0.47	1
4	Medical Version (M5)	2 x 1.5	68		1
4	Medical Version (M5)	2 x 1.5	68	0.47	1
6	Medical Version (M5)	2 x 0.8	68		1
6	Medical Version (M5)	2 x 1.5	68		1
10	Medical Version (M5)	2 x 0.3	68		1

Diagrams

Standard version with fuseholder 1- or 2-pole

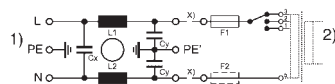

Medical version (M5) with fuseholder 2-pole

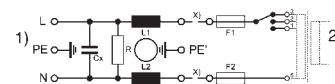

Standard version without voltage selector

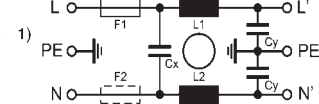

Medical version (M5) without voltage selector

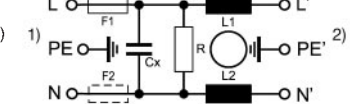

1) Line; 2) Load; x) external connection to be made by the customer

1) Line  
2) Load

Medical version (M80) with voltage selector

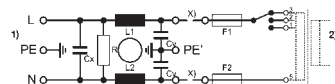

Medical version (M80) without voltage selector

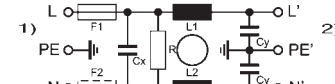

1) Line; 2) Load; x) external connection to be made by customer

1) Line  
2) Load

Derating curves

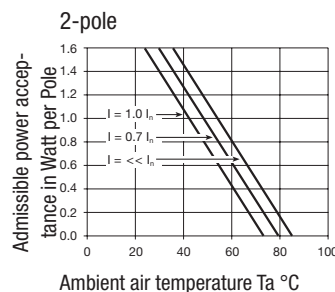
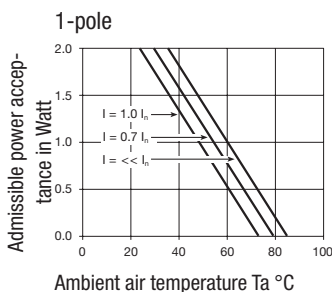

**Attenuation loss**

--- differential mode \_\_\_\_ common mode

Standard version

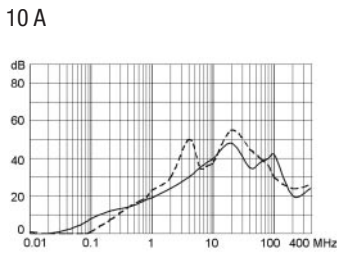
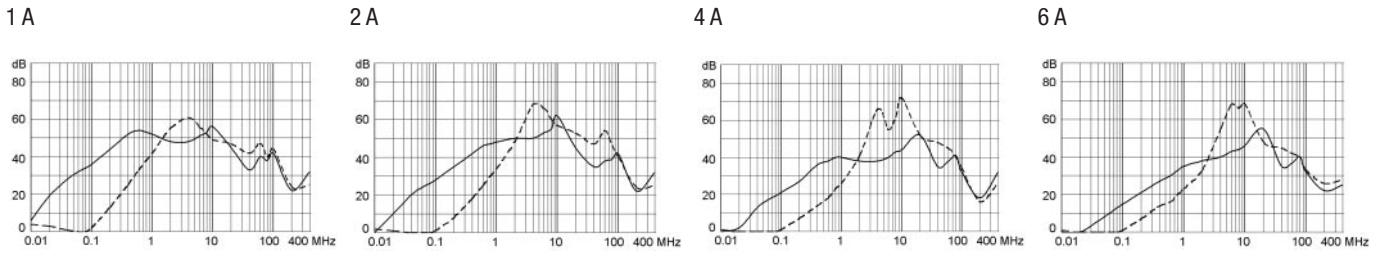

Medical version (M5)

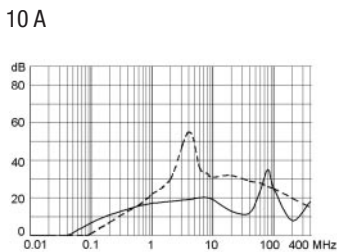
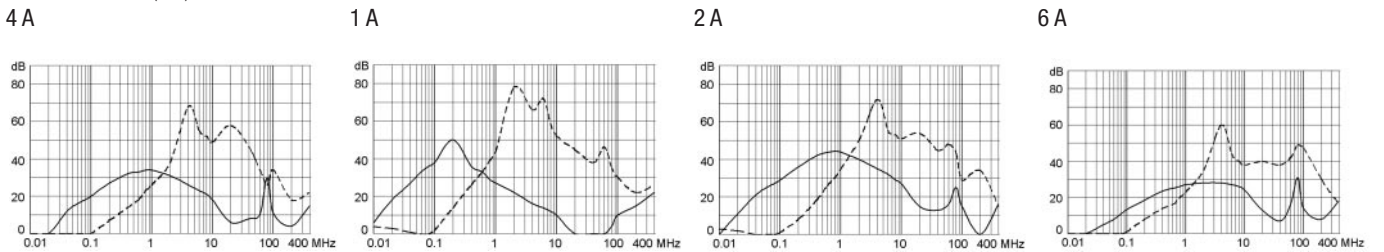

**Variants**

Fuse drawer must be ordered separately (See accessories).

Rated Current [A]	Filter-Type	Panel mounting	Mounting side	Fuseholder	Terminals	Voltage selector	Order Number
1	Standard Version	Snap-in	Front-Side	1-pole	Quick connect terminals		4301.6011
1	Standard Version	Snap-in	Front-Side	2-pole	Quick connect terminals		4301.6001
2	Standard Version	Snap-in	Front-Side	1-pole	Quick connect terminals		4301.6012
2	Standard Version	Snap-in	Front-Side	2-pole	Quick connect terminals		4301.6002
4	Standard Version	Snap-in	Front-Side	1-pole	Quick connect terminals		4301.6013
4	Standard Version	Snap-in	Front-Side	2-pole	Quick connect terminals		4301.6003
6	Standard Version	Snap-in	Front-Side	1-pole	Quick connect terminals		4301.6014
6	Standard Version	Snap-in	Front-Side	2-pole	Quick connect terminals		4301.6004
10	Standard Version	Snap-in	Front-Side	1-pole	Quick connect terminals		4301.6015
10	Standard Version	Snap-in	Front-Side	2-pole	Quick connect terminals		4301.6005
1	Standard Version	Screw-on	Front-Side	1-pole	Quick connect terminals		4301.5011
1	Standard Version	Screw-on	Front-Side	1-pole	Quick connect terminals 4.8 x 0.8	3 digits	4301.5051
1	Standard Version	Screw-on	Front-Side	2-pole	Quick connect terminals		4301.5001
1	Standard Version	Screw-on	Front-Side	2-pole	Quick connect terminals 4.8 x 0.8	3 digits	4301.5041
1	Standard Version	Screw-on	Rear-Side	1-pole	Flexible wire 18 AWG		4301.7311
1	Standard Version	Screw-on	Rear-Side	1-pole	Quick connect terminals		4301.7011
1	Standard Version	Screw-on	Rear-Side	2-pole	Flexible wire 18 AWG		4301.7301

Rated Current [A]	Filter-Type	Panel mounting	Mounting side	Fuseholder	Terminals	Voltage selector	Order Number
1	Standard Version	Screw-on	Rear-Side	2-pole	Quick connect terminals		4301.7001
1	Standard Version	Screw-on	Rear-Side	2-pole	Quick connect terminals		4301.7002
2	Standard Version	Screw-on	Front-Side	1-pole	Quick connect terminals		4301.5012
2	Standard Version	Screw-on	Front-Side	1-pole	Quick connect terminals 4.8 x 0.8	3 digits	4301.5052
2	Standard Version	Screw-on	Front-Side	2-pole	Quick connect terminals		4301.5002
2	Standard Version	Screw-on	Front-Side	2-pole	Quick connect terminals 4.8 x 0.8	3 digits	4301.5042
2	Standard Version	Screw-on	Rear-Side	1-pole	Quick connect terminals		4301.7012
2	Standard Version	Screw-on	Rear-Side	2-pole	Quick connect terminals		4301.7002
2	Standard Version	Screw-on	Rear-Side	2-pole	Quick connect terminals		4301.7004
4	Standard Version	Screw-on	Front-Side	1-pole	Quick connect terminals		4301.5013
4	Standard Version	Screw-on	Front-Side	1-pole	Quick connect terminals 4.8 x 0.8	3 digits	4301.5053
4	Standard Version	Screw-on	Front-Side	2-pole	Quick connect terminals		4301.5003
4	Standard Version	Screw-on	Front-Side	2-pole	Quick connect terminals 4.8 x 0.8	3 digits	4301.5043
4	Standard Version	Screw-on	Rear-Side	1-pole	Quick connect terminals		4301.7013
4	Standard Version	Screw-on	Rear-Side	2-pole	Quick connect terminals		4301.7003
4	Standard Version	Screw-on	Rear-Side	2-pole	Quick connect terminals		4301.7006
6	Standard Version	Screw-on	Front-Side	1-pole	Quick connect terminals		4301.5014
6	Standard Version	Screw-on	Front-Side	1-pole	Quick connect terminals 4.8 x 0.8	3 digits	4301.5054
6	Standard Version	Screw-on	Front-Side	2-pole	Quick connect terminals		4301.5004
6	Standard Version	Screw-on	Front-Side	2-pole	Quick connect terminals 4.8 x 0.8	3 digits	4301.5044
6	Standard Version	Screw-on	Rear-Side	1-pole	Quick connect terminals		4301.7014
6	Standard Version	Screw-on	Rear-Side	2-pole	Quick connect terminals		4301.7004
6	Standard Version	Screw-on	Rear-Side	2-pole	Quick connect terminals		4301.7208
10	Standard Version	Screw-on	Front-Side	1-pole	Quick connect terminals		4301.5015
10	Standard Version	Screw-on	Front-Side	1-pole	Quick connect terminals 4.8 x 0.8	3 digits	4301.5055
10	Standard Version	Screw-on	Front-Side	2-pole	Quick connect terminals		4301.5005
10	Standard Version	Screw-on	Front-Side	2-pole	Quick connect terminals 4.8 x 0.8	3 digits	4301.5045
10	Standard Version	Screw-on	Rear-Side	1-pole	Quick connect terminals		4301.7015
10	Standard Version	Screw-on	Rear-Side	2-pole	Quick connect terminals		4301.7005
10	Standard Version	Screw-on	Rear-Side	2-pole	Quick connect terminals		4301.7000
1	Medical Version (M5)	Snap-in	Front-Side	2-pole	Quick connect terminals		4301.6201
2	Medical Version (M5)	Snap-in	Front-Side	2-pole	Quick connect terminals		4301.6203
4	Medical Version (M5)	Snap-in	Front-Side	2-pole	Quick connect terminals		4301.6205
4	Medical Version (M5)	Snap-in	Front-Side	2-pole	Quick connect terminals		4301.6206
4	Medical Version (M5)	Snap-in	Front-Side	2-pole	Quick connect terminals		4301.6209
6	Medical Version (M5)	Snap-in	Front-Side	2-pole	Quick connect terminals		4301.6207
1	Medical Version (M5)	Screw-on	Front-Side	2-pole	Quick connect terminals 4.8 x 0.8	3 digits	4301.5241
1	Medical Version (M5)	Screw-on	Rear-Side	2-pole	Quick connect terminals		4301.7201
2	Medical Version (M5)	Screw-on	Front-Side	2-pole	Quick connect terminals 4.8 x 0.8	3 digits	4301.5243
2	Medical Version (M5)	Screw-on	Front-Side	2-pole	Quick connect terminals 4.8 x 0.8	3 digits	4301.5244
2	Medical Version (M5)	Screw-on	Rear-Side	2-pole	Quick connect terminals		4301.7203
4	Medical Version (M5)	Screw-on	Front-Side	2-pole	Quick connect terminals		4301.5206
4	Medical Version (M5)	Screw-on	Front-Side	2-pole	Quick connect terminals 4.8 x 0.8	3 digits	4301.5245
4	Medical Version (M5)	Screw-on	Rear-Side	2-pole	Quick connect terminals		4301.7205
4	Medical Version (M5)	Screw-on	Rear-Side	2-pole	Quick connect terminals		4301.7207
4	Medical Version (M5)	Screw-on	Rear-Side	2-pole	Quick connect terminals		4301.7209
6	Medical Version (M5)	Screw-on	Front-Side	2-pole	Quick connect terminals		4301.5217
6	Medical Version (M5)	Screw-on	Front-Side	2-pole	Quick connect terminals 4.8 x 0.8	3 digits	4301.5247
10	Medical Version (M5)	Screw-on	Front-Side	2-pole	Quick connect terminals		4301.5209
10	Medical Version (M5)	Screw-on	Front-Side	2-pole	Quick connect terminals 4.8 x 0.8	3 digits	4301.5249

Wire lenght: 150 mm

Packaging unit 10 Pcs