

PRODUCT NUMBER
SEE TABLE

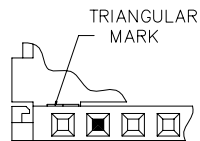
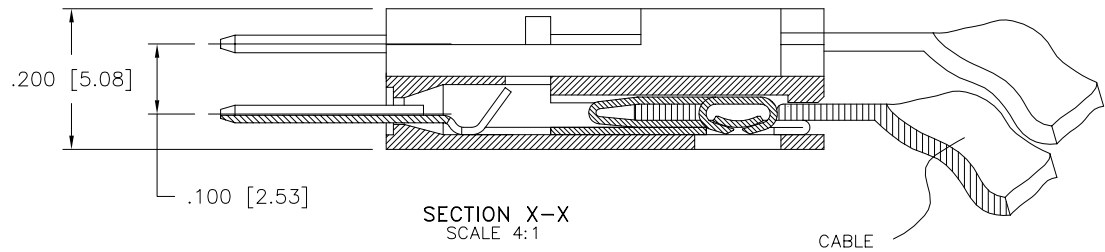
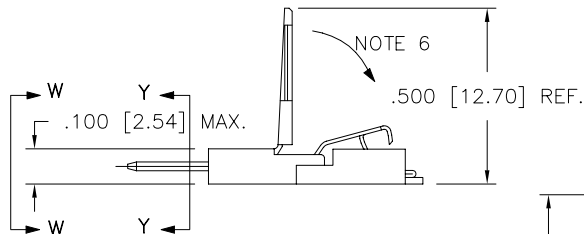
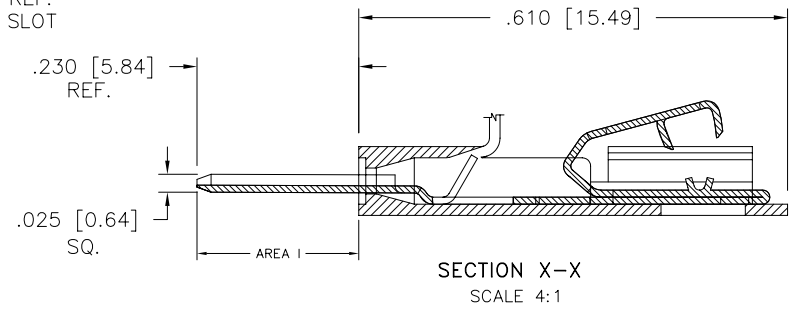
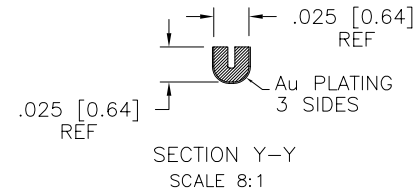
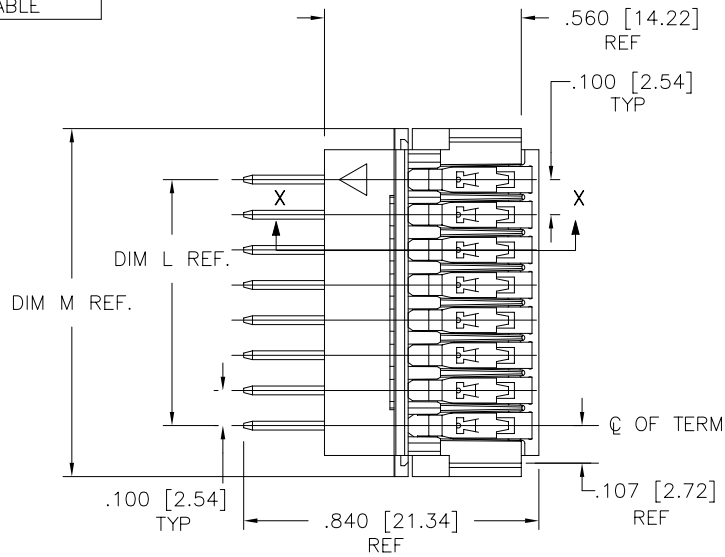

VIEW W-W
NOTE 7

CABLE TERMINATED
AND LID CLOSED

mat'l. code		surface ISO 1302 ✓		tolerance ISO 406 ISO 1101		projection ⊕		product family CLINCHER	
ltr	ecn no	dr	date	tolerances unless otherwise specified		INCH/MM		title	
P	V17523	HTB	10/28/97	angles	linear	.xx±.01/.3		CLINCHER™ PIN ASSEMBLY	
R	V00611	RGD	2/23/00	0°±2'		.xxx±.005/.13		dwg no	
S	V00672	RGD	6/23/00			.xxxx±.0020/.051		sheet 1 of 4 size	
T	V01741	RGD	8/4/00	dr	P.PARSONS	9/13/93		A3	
U	M05-0154	MHT	6/27/05	engr	T. HANNA	9/13/93		66226	
V	M06-0233	AGS	06/13/06	chr	T.BREWBAKER	9/13/93		type	
W	M07-0156	MHT	3/14/07	appd	T. HANNA	9/13/93		Product Customer Drawing	
sheet	revision	W	W	W	W				
index	sheet	1	2	3	4				



Copyright FCI

PRODUCT NO.	NO. OF	DIM L	DIM L	DIM M	DIM M	DIM N	DIM N	PLATING	COLOR
NOTE 8	POSITION	ENGLISH	METRIC	ENGLISH	METRIC	ENGLISH	METRIC	CODE	
66226-001			U N A	S S I G	N E D				
66226-002	2	0.100	2.54	0.390	9.91	0.315	8.00	1	BLUE
66226-003	3	0.200	5.08	0.490	12.45	0.415	10.54	1	BLUE
66226-004	4	0.300	7.62	0.590	14.99	0.515	13.08	1	BLUE
66226-005	5	0.400	10.16	0.690	17.53	0.615	15.62	1	BLUE
66226-006	6	0.500	12.70	0.790	20.07	0.715	18.16	1	BLUE
66226-007	7	0.600	15.24	0.890	22.61	0.815	20.70	1	BLUE
66226-008	8	0.700	17.78	0.990	25.15	0.915	23.24	1	BLUE
66226-009	9	0.800	20.32	1.090	27.69	1.015	25.78	1	BLUE
66226-010	10	0.900	22.86	1.190	30.23	1.115	28.32	1	BLUE
66226-011	11	1.000	25.40	1.290	32.77	1.215	30.86	1	BLUE
66226-012	12	1.100	27.94	1.390	35.31	1.315	33.40	1	BLUE
66226-013	13	1.200	30.48	1.490	37.85	1.415	35.94	1	BLUE
66226-014	14	1.300	33.02	1.590	40.39	1.515	38.48	1	BLUE
66226-015	15	1.400	35.56	1.690	42.93	1.615	41.02	1	BLUE
66226-016	16	1.500	38.10	1.790	45.47	1.715	43.56	1	BLUE
66226-017	17	1.600	40.64	1.890	48.01	1.815	46.10	1	BLUE
66226-018	18	1.700	43.18	1.990	50.55	1.915	48.64	1	BLUE
66226-019	19	1.800	45.72	2.090	53.09	2.015	51.18	1	BLUE
66226-020	20	1.900	48.26	2.190	55.63	2.115	53.72	1	BLUE
66226-021	21	2.000	50.80	2.290	58.17	2.215	56.26	1	BLUE
66226-022	22	2.100	53.34	2.390	60.71	2.315	58.80	1	BLUE
66226-023	23	2.200	55.88	2.490	63.25	2.415	61.34	1	BLUE
66226-024	24	2.300	58.42	2.590	65.79	2.515	63.88	1	BLUE
66226-025	25	2.400	60.96	2.690	68.33	2.615	66.42	1	BLUE
66226-026	26	2.500	63.50	2.790	70.87	2.715	68.96	1	BLUE
66226-027	27	2.600	66.04	2.890	73.41	2.815	71.50	1	BLUE
66226-028	28	2.700	68.58	2.990	75.95	2.915	74.04	1	BLUE
66226-029	29	2.800	71.12	3.090	78.49	3.015	76.58	1	BLUE
66226-030	30	2.900	73.66	3.190	81.03	3.115	79.12	1	BLUE
66226-031	31	3.000	76.20	3.290	83.57	3.215	81.66	1	BLUE
66226-032	32	3.100	78.74	3.390	86.11	3.315	84.20	1	BLUE



Copyright FCI

mat'l. code		surface ISO 1302 <input checked="" type="checkbox"/>		tolerance ISO 406 ISO 1101		projection 		product family CLINCHER	
ltr		ecn no		dr		date		title	
w								CLINCHER™ PIN ASSEMBLY	
								INCH/MM	
								scale 2:1	
				dr		P.PARSONS 9/13/93		dwg no	
				enr		T. HANNA 9/13/93		sheet 2 of 4 size	
				chr		T.BREWBAKER 9/13/93		66226 A3	
				appd		T. HANNA 9/13/93		type Product Customer Drawing	
sheet index		revision sheet							

PRODUCT NO.	NO. OF	DIM L	DIM L	DIM M	DIM M	DIM N	DIM N	PLATING	COLOR
NOTE 8	POSITION	ENGLISH	METRIC	ENGLISH	METRIC	ENGLISH	METRIC	CODE	
66226-033			U N A	S S I G	N E D				
66226-034	2	0.100	2.54	0.390	9.91	0.315	8.00	2	BLUE
66226-035	3	0.200	5.08	0.490	12.45	0.415	10.54	2	BLUE
66226-036	4	0.300	7.62	0.590	14.99	0.515	13.08	2	BLUE
66226-037	5	0.400	10.16	0.690	17.53	0.615	15.62	2	BLUE
66226-038	6	0.500	12.70	0.790	20.07	0.715	18.16	2	BLUE
66226-039	7	0.600	15.24	0.890	22.61	0.815	20.70	2	BLUE
66226-040	8	0.700	17.78	0.990	25.15	0.915	23.24	2	BLUE
66226-041	9	0.800	20.32	1.090	27.69	1.015	25.78	2	BLUE
66226-042	10	0.900	22.86	1.190	30.23	1.115	28.32	2	BLUE
66226-043	11	1.000	25.40	1.290	32.77	1.215	30.86	2	BLUE
66226-044	12	1.100	27.94	1.390	35.31	1.315	33.40	2	BLUE
66226-045	13	1.200	30.48	1.490	37.85	1.415	35.94	2	BLUE
66226-046	14	1.300	33.02	1.590	40.39	1.515	38.48	2	BLUE
66226-047	15	1.400	35.56	1.690	42.93	1.615	41.02	2	BLUE
66226-048	16	1.500	38.10	1.790	45.47	1.715	43.56	2	BLUE
66226-049	17	1.600	40.64	1.890	48.01	1.815	46.10	2	BLUE
66226-050	18	1.700	43.18	1.990	50.55	1.915	48.64	2	BLUE
66226-051	19	1.800	45.72	2.090	53.09	2.015	51.18	2	BLUE
66226-052	20	1.900	48.26	2.190	55.63	2.115	53.72	2	BLUE
66226-053	21	2.000	50.80	2.290	58.17	2.215	56.26	2	BLUE
66226-054	22	2.100	53.34	2.390	60.71	2.315	58.80	2	BLUE
66226-055	23	2.200	55.88	2.490	63.25	2.415	61.34	2	BLUE
66226-056	24	2.300	58.42	2.590	65.79	2.515	63.88	2	BLUE
66226-057	25	2.400	60.96	2.690	68.33	2.615	66.42	2	BLUE
66226-058	26	2.500	63.50	2.790	70.87	2.715	68.96	2	BLUE
66226-059	27	2.600	66.04	2.890	73.41	2.815	71.50	2	BLUE
66226-060	28	2.700	68.58	2.990	75.95	2.915	74.04	2	BLUE
66226-061	29	2.800	71.12	3.090	78.49	3.015	76.58	2	BLUE
66226-062	30	2.900	73.66	3.190	81.03	3.115	79.12	2	BLUE
66226-063	31	3.000	76.20	3.290	83.57	3.215	81.66	2	BLUE
66226-064	32	3.100	78.74	3.390	86.11	3.315	84.20	2	BLUE



Copyright FCI

mat'l. code		surface ISO 1302 <input checked="" type="checkbox"/>		tolerance ISO 406 ISO 1101		projection 		product family CLINCHER	
ltr		ecn no		dr		date		tolerances unless otherwise specified	
W								.xx±.01/.3	
								linear .xxx±.005/.13	
								.xxx±.0020/.051	
								INCH/MM	
								scale 2:1	
				dr		P.PARSONS		9/13/93	
				enr		T. HANNA		9/13/93	
				chr		T.BREWBAKER		9/13/93	
				appd		T. HANNA		9/13/93	
sheet index		revision sheet							

PRODUCT NO.	NO. OF	DIM L	DIM L	DIM M	DIM M	DIM N	DIM N	PLATING	POSITION NO.	TERMINAL NO.	COLOR
NOTE 8	POSITION	ENGLISH	METRIC	ENGLISH	METRIC	ENGLISH	METRIC	CODE	CLOSED (SEE NOTE 7)	ABSENT (SEE NOTE 7)	
66226-202	12	1.100	27.94	1.390	35.31	1.315	33.40	2	5	5	BLUE
66226-203	7	0.600	15.24	0.890	22.61	1.815	46.10	2	2	2	BLUE
66226-208	13	1.200	30.48	1.490	37.85	1.415	35.94	2	N/A	5	BLUE
66226-212	14	1.300	33.02	1.590	40.39	1.515	38.48	2	N/A	5,6,7,8,13	BLUE
66226-215	12	1.100	27.94	1.390	35.31	1.315	33.40	2	N/A	8	BLUE
66226-216	12	1.100	27.94	1.390	35.31	1.315	33.40	2	N/A	11	BLUE
66226-217	6	0.500	12.70	0.790	20.07	0.715	18.16	2	N/A	6	BLUE

NOTES :

- ① HOUSING MATERIAL : THERMOPLASTIC, FLAME RETARDANT PER UL94V-0. COLOR: SEE TABLE.
- ② TERMINAL MATERIAL : 1/2 HARD CU Ni ALLOY, UNS-C72500.
- ③ TERMINAL PLATING : SEE PART NO. TABULATION.
4. SEE TA-372 FOR CRIMP HEIGHT.
5. FOR CABLE AND CIRCUITRY INFO. SEE TA-264 & 371.
6. LATCH SWINGS CLOSED AFTER TERMINATION MAINTAINING A MAX. OVER ALL HEIGHT OF .100/2.54.
- ⑦ FIGURE SHOWS POSITION NO. 2 CLOSED. POSITION NUMBERS INITIATE FROM TRIANGULAR MARK END. SEE CHART FOR CLOSED AND EMPTY POSITION(S).
- ⑧ ADD "LF" SUFFIX AT THE END OF PART NUMBER FOR LEAD FREE OPTION.
- ⑨ THIS PRODUCT MEETS EUROPEAN UNION DIRECTIVES AND OTHER COUNTRY REGULATION AS DESCRIBED IN GS-22-008.
- 10 THE PRODUCT IS NOT INTENDED TO BE EXPOSED TO A MANUFACTURING SOLDER PROCESS
- ⑩ PLATING OPTIONS: MAY BE EITHER GOLD OR GXT PLATED AT MANUFACTURER'S OPTION.

PRODUCT NUMBER

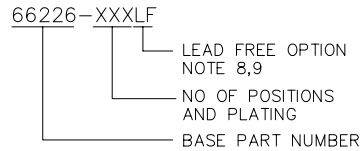

NO.	TERMINAL PLATING
1	100u"/2.54u MIN. Sn (ALL OVER)
2	30u"/0.76u MIN Au or GXT IN AREA 1 (SEE SECT. Y-Y SH. 1) NOTE 11

mat'l. code		surface ISO 1302 <input checked="" type="checkbox"/>		tolerance ISO 406 ISO 1101		projection 		product family CLINCHER			
ltr	ecn	no	dr	date		tolerances unless otherwise specified		title			
W						angles	linear	CLINCHER™ PIN ASSEMBLY			
						0'±2'	.xx±.01/.3 .xxx±.005/.13 .xxxx±.0020/.051	INCH/MM			
								scale 2:1			
				dr	P. PARSONS	9/13/93			dwg no	sheet 4 of 4	size
				enr	T. HANNA	9/13/93			66226	A3	
				chr	T. BREWBAKER	9/13/93					
				appd	T. HANNA	9/13/93					
sheet index	revision sheet										