

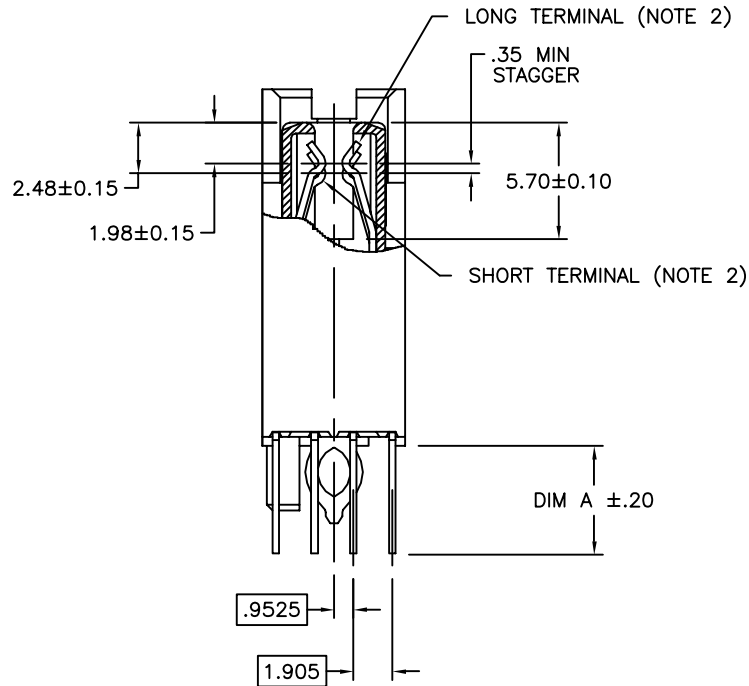



Tous droits strictement reserves. Reproduction ou communication a des tiers interdite sous quelque forme que ce soit sans autorisation ecrite du proprietaire. Propriete de c FCI. Droits de reproduction FCI.

All rights strictly reserved. Reproduction or issue to third parties in any form whatever is not permitted without written authority from the proprietor. Property of FCI. Copyright FCI.



SECTION A-A

CONFIDENTIAL

mat'l. code		tolerances unless otherwise specified		CUSTOMER COPY		 www.fciconnect.com	
ltr	ecn no	dr	date	linear	.X ±.3	projection	
H					.XX ±.13		
					.XXX ±.051		
				angles	0° ±2'	 MM	title SCA-2 & FIBER CHANNEL 80 POS. RECEPT. ASS'Y EXT. HT. product family SCA-2 size dwg no A 72442 code - sheet 2 of 4
				dr	M. FETROW 9/24/96		
				enr	A. RAISTRICK 9/24/96		
				chr	GL L00 11/22/04		
				appd	JOEY NG 11/22/04		
sheet index	revision sheet					scale	2:1

cage code
22526

ACAD

PDM: Rev:H

STATUS: Released

Printed: May 26, 2010

Tous droits strictement reserves. Reproduction ou communication a des tiers interdite sous quelque forme que ce soit sans autorisation écrite du propriétaire. Propriete de c FCI. Droits de reproduction FCI.

All rights strictly reserved. Reproduction or issue to third parties in any form whatever is not permitted without written authority from the proprietor. Property of FCI. Copyright FCI.

PRODUCT NO.	DIM A	POLARIZATION PEG	PLATING	RECOMMENDED P.C. BOARD THICKNESS	PRODUCT NO.	PLATING
72442-001	3.79	YES	NOTE 4	2.36mm (0.093") AND 3.18mm (0.125")	72442-101	NOTE 6
-001S					-101S	
-002					-102	
-002S	-102S					
-003	-103					
-003S	-103S					
-004	4.60	NO	-104	72442-104S		
-004S						

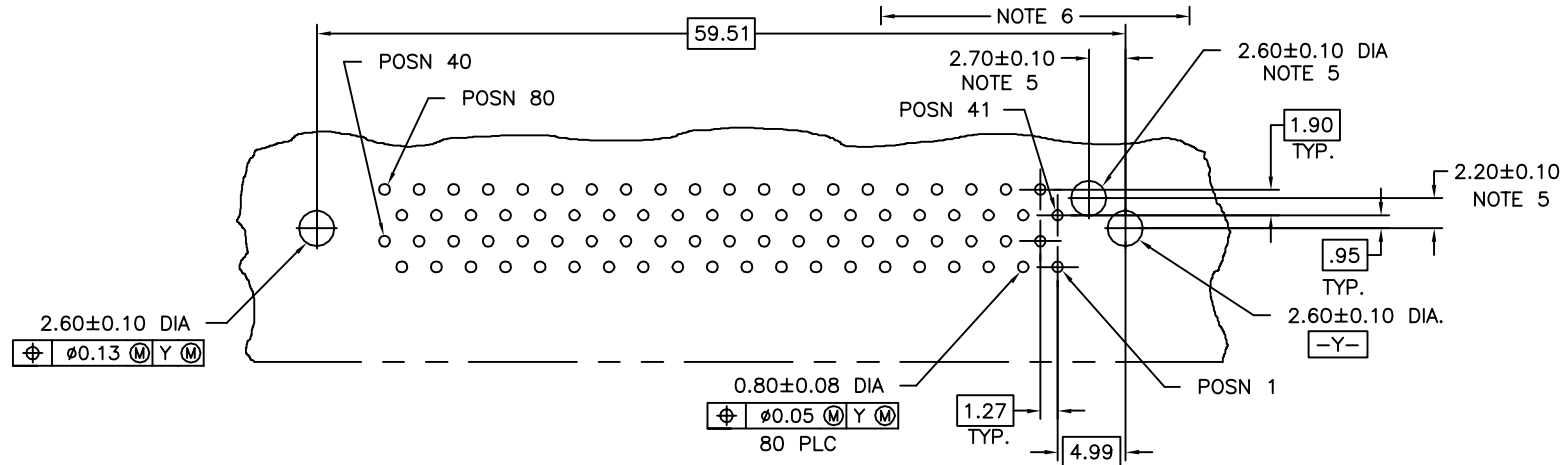

NOTES :

- TRUE POSITION NOTES APPLY AT TERMINAL TIP.
- CONTACTS IN POSITIONS 2 THRU 35, 44 AND 47 THRU 74 ARE SHORT TERMINALS.
CONTACTS IN POSITIONS 1, 36 THRU 43, 45, 46, AND 75 THRU 80 ARE LONG TERMINALS.
- RAW MATERIALS:
HOUSING: HTN, UL94V-0, COLOR: BLACK
CONTACTS: PHOSPHOR-BRONZE
- CONTACT PLATING: 30u" (0.76um) MIN. GXT PLATING OVER 50u" (1.27um) NICKLE MIN. UNDERPLATE IN CONTACT AREA. 20u" (0.5um) MIN-60u" (1.5um)MAX TIN-LEAD PLATING OVER 50u" (1.27um) MIN. NICKLE UNDERPLATE IN P.C. BOARD LEG AREA. 50u" (1.27um) MIN. NICKLE UNDERPLATE OVER REMAINING AREA.
- DIMENSIONS DO NOT APPLY TO CONNECTOR STYLES WITHOUT POLARIZATION PEG. (SEE CHART)
- CONTACT PLATING: 30u" (0.76um) MIN. GOLD PLATING OVER 50u" (1.27um) NICKLE MIN. UNDERPLATE IN CONTACT AREA. 20u" (0.5um) MIN-60u" (1.5um)MAX TIN-LEAD PLATING OVER 50u" (1.27um) MIN. NICKLE UNDERPLATE IN P.C. BOARD LEG AREA. 50u" (1.27um) MIN. NICKLE UNDERPLATE OVER REMAINING AREA.

RECOMMENDED PC BOARD MOUNTING DIMENSIONS COMPONENT SIDE

7. PART NUMBERS WITH SUFFIX "S" ARE MANUFACTURED WITH BRIGHT FINISH TIN-LEAD PLATING IN P.C. BOARD LEG AREA.

CONFIDENTIAL

mat'l. code		tolerances unless otherwise specified		CUSTOMER COPY		FCI www.fciconnect.com	
ltr	ecn no	dr	date	linear	.X ±.3	projection	title
H					.XX ±.13	MM	SCA-2 & FIBER CHANNEL
				angles	.XXX ±.051	MM	80 POS. RECEPT. ASS'Y EXT. HT.
				dr	0° ±2°	MM	product family
				enr	M. FETROW 9/24/96	MM	SCA-2
				chr	A. RAISTRICK 9/24/96	MM	code
				appd	GL L00 11/22/04	MM	size
					JOEY NG 11/22/04	MM	dwg no
sheet index	revision sheet					2:1	72442
							3 of 4

cage code 22526

ACAD

Tous droits strictement reserves. Reproduction ou communication a des tiers interdite sous quelque forme que ce soit sans autorisation écrite du propriétaire. Propriete de c FCI. Droits de reproduction FCI.

All rights strictly reserved. Reproduction or issue to third parties in any form whatever is not permitted without written authority from the proprietor. Property of FCI. Copyright FCI.

1 | 2

3 |

4





PRODUCT NO.	DIM A	POLARIZATION PEG	PLATING	RECOMMENDED P.C. BOARD THICKNESS	PRODUCT NO.	PLATING
72442-001LF	3.79	YES	NOTE 9	2.36mm (0.093") AND 3.18mm (0.125")	72442-201LF	NOTE 8
-002LF	3.79	NO			-202LF	
-003LF	4.60	YES			-203LF	
72442-004LF	4.60	NO			72442-204LF	

← NOTE 8 →

NOTES :

- ⑧ CONTACT PLATING: 30u" (0.76um) GOLD PLATING OVER 50u" (1.27um) NICKLE UNDERPLATE IN CONTACT AREA. 20u" (0.5um) - 60u"(1.5um) TIN PLATING OVER 50u" (1.27um) -100u" (2.54um) NICKEL UNDERPLATE IN P.C. BOARD LEG AREA. 50u" (1.27um) NICKEL UNDERPLATE OVER REMAINING AREA.
- ⑨ CONTACT PLATING: 30u" (0.76um) GXT PLATING OVER 50u" (1.27um) NICKLE UNDERPLATE IN CONTACT AREA. 20u" (0.5um) - 60u"(1.5um) TIN PLATING OVER 50u" (1.27um) -100u" (2.54um) NICKEL UNDERPLATE IN P.C. BOARD LEG AREA. 50u" (1.27um) NICKEL UNDERPLATE OVER REMAINING AREA.
- ⑩ THE HOUSING WILL WITHSTAND EXPOSURE TO 260° C PEAK TEMPERATURE FOR 10 SECONDS IN A CONVECTION, INFRA RED VAPOR PHASE REFLOW OVEN.
- ⑪ THIS PRODUCT MEETS EUROPEAN UNION DIRECTIVES AND OTHER COUNTRY REGULATIONS AS DESCRIBED IN GS-22-008.
- 12 PART NUMBERS ENDING IN "LF" MEANS FOR NOTE 11 LEAD FREE IDENTIFICATION.

CONFIDENTIAL

mat'l. code		tolerances unless otherwise specified		CUSTOMER COPY		 www.fciconnect.com					
ltr	ecn no	dr	date	linear	.X ±.3	projection					
H					.XX ±.13						
					.XXX ±.051						
				angles	0° ±2'	 MM	 scale				
				dr	M. FETROW 9/24/96			A	72442		
				enr	A. RAISTRICK 9/24/96					product family	code
				chr	GL L00 11/22/04					size	sheet
				appd	JOEY NG 11/22/04	dwg no	4 of 4				
sheet index	revision sheet										

cage code 22526

1 | 2

3 |

4

ACAD