

# BZX84B4V7LT1, BZX84C2V4LT1 Series

## Zener Voltage Regulators

### 225 mW SOT-23 Surface Mount

This series of Zener diodes is offered in the convenient, surface mount plastic SOT-23 package. These devices are designed to provide voltage regulation with minimum space requirement. They are well suited for applications such as cellular phones, hand held portables, and high density PC boards.

#### Features

- 225 mW Rating on FR-4 or FR-5 Board
- Zener Breakdown Voltage Range - 2.4 V to 75 V
- Package Designed for Optimal Automated Board Assembly
- Small Package Size for High Density Applications
- ESD Rating of Class 3 (>16 KV) per Human Body Model
- Tight Tolerance Series Available (See Page 4)
- Pb-Free Packages are Available

#### Mechanical Characteristics

**CASE:** Void-free, transfer-molded, thermosetting plastic case

**FINISH:** Corrosion resistant finish, easily Solderable

**MAXIMUM CASE TEMPERATURE FOR SOLDERING PURPOSES:**  
260°C for 10 Seconds

**POLARITY:** Cathode indicated by polarity band

**FLAMMABILITY RATING:** UL 94 V-0

#### MAXIMUM RATINGS

Rating	Symbol	Max	Unit
Total Power Dissipation on FR-5 Board, (Note 1) @ T <sub>A</sub> = 25°C Derated above 25°C	P <sub>D</sub>	225	mW
Thermal Resistance, Junction-to-Ambient	R <sub>θJA</sub>	1.8	mW/°C
Total Power Dissipation on Alumina Substrate, (Note 2) @ T <sub>A</sub> = 25°C Derated above 25°C	P <sub>D</sub>	300	mW
Thermal Resistance, Junction-to-Ambient	R <sub>θJA</sub>	2.4	mW/°C
Junction and Storage Temperature Range	T <sub>J</sub> , T <sub>stg</sub>	-65 to +150	°C

Stresses exceeding Maximum Ratings may damage the device. Maximum Ratings are stress ratings only. Functional operation above the Recommended Operating Conditions is not implied. Extended exposure to stresses above the Recommended Operating Conditions may affect device reliability.

1. FR-5 = 1.0 X 0.75 X 0.62 in.

2. Alumina = 0.4 X 0.3 X 0.024 in., 99.5% alumina.



ON Semiconductor®

<http://onsemi.com>

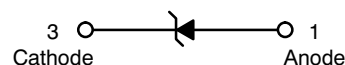

#### MARKING DIAGRAM

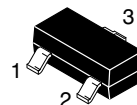

SOT-23  
CASE 318  
STYLE 8

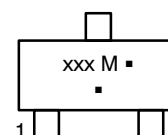

xxx = Device Code  
M = Date Code\*  
■ = Pb-Free Package

(Note: Microdot may be in either location)

\* Date Code orientation may vary depending upon manufacturing location.

#### ORDERING INFORMATION

Device	Package	Shipping†
BZX84CxxxLT1	SOT-23	3000/Tape & Reel
BZX84CxxxLT1G	SOT-23 (Pb-Free)	3000/Tape & Reel
BZX84CxxxLT3	SOT-23	10,000/Tape & Reel
BZX84CxxxLT3G	SOT-23 (Pb-Free)	10,000/Tape & Reel
BZX84BxxxLT1	SOT-23	3000/Tape & Reel
BZX84BxxxLT1G	SOT-23 (Pb-Free)	3000/Tape & Reel
BZX84BxxxLT3	SOT-23	10,000/Tape & Reel
BZX84BxxxLT3G	SOT-23 (Pb-Free)	10,000/Tape & Reel

†For information on tape and reel specifications, including part orientation and tape sizes, please refer to our Tape and Reel Packaging Specification Brochure, BRD8011/D.

#### DEVICE MARKING INFORMATION

See specific marking information in the device marking column of the Electrical Characteristics table on page 3 of this data sheet.

## BZX84B4V7LT1, BZX84C2V4LT1 Series

### ELECTRICAL CHARACTERISTICS

(Pinout: 1-Anode, 2-No Connection, 3-Cathode) ( $T_A = 25^\circ\text{C}$  unless otherwise noted,  $V_F = 0.95\text{ V Max. @ } I_F = 10\text{ mA}$ )

Symbol	Parameter
$V_Z$	Reverse Zener Voltage @ $I_{ZT}$
$I_{ZT}$	Reverse Current
$Z_{ZT}$	Maximum Zener Impedance @ $I_{ZT}$
$I_R$	Reverse Leakage Current @ $V_R$
$V_R$	Reverse Voltage
$I_F$	Forward Current
$V_F$	Forward Voltage @ $I_F$
$\Theta_{VZ}$	Maximum Temperature Coefficient of $V_Z$
C	Max. Capacitance @ $V_R = 0$ and $f = 1\text{ MHz}$

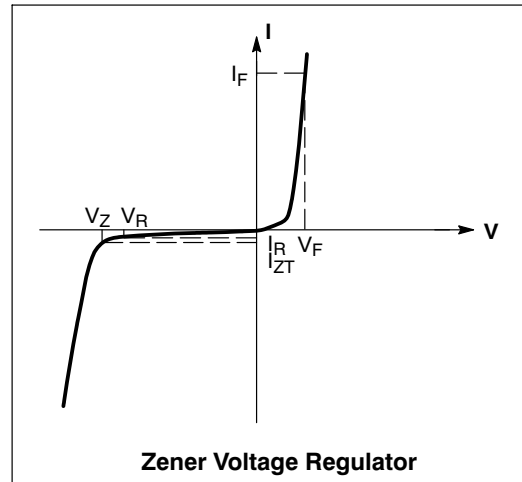

## BZX84B4V7LT1, BZX84C2V4LT1 Series

### ELECTRICAL CHARACTERISTICS – BZX84CxxxLT1 SERIES (STANDARD TOLERANCE)

(Pinout: 1-Anode, 2-No Connection, 3-Cathode) (T<sub>A</sub> = 25°C unless otherwise noted, V<sub>F</sub> = 0.90 V Max. @ I<sub>F</sub> = 10 mA)  
 (Devices listed in **bold, italic** are ON Semiconductor Preferred devices.)

Device*	Device Marking	V <sub>Z1</sub> (Volts) @ I <sub>ZT1</sub> = 5 mA (Note 3)			Z <sub>ZT1</sub> (Ω) @ I <sub>ZT1</sub> = 5 mA	V <sub>Z2</sub> (V) @ I <sub>ZT2</sub> = 1 mA (Note 3)		Z <sub>ZT2</sub> (Ω) @ I <sub>ZT2</sub> = 1 mA	V <sub>Z3</sub> (V) @ I <sub>ZT3</sub> = 20 mA (Note 3)		Z <sub>ZT3</sub> (Ω) @ I <sub>ZT3</sub> = 20 mA	Max Reverse Leakage Current		θ <sub>VZ</sub> (mV/k) @ I <sub>ZT1</sub> = 5 mA		C (pF) @ V <sub>R</sub> = 0 f = 1 MHz
		Min	Nom	Max		Min	Max		Min	Max		I <sub>R</sub> (μA)	V <sub>R</sub> (Volts)	Min	Max	
BZX84C2V4LT1, G	Z11	2.2	2.4	2.6	100	1.7	2.1	600	2.6	3.2	50	50	1	-3.5	0	450
BZX84C2V7LT1, G	Z12	2.5	2.7	2.9	100	1.9	2.4	600	3	3.6	50	20	1	-3.5	0	450
BZX84C3V0LT1, G	Z13	2.8	3	3.2	95	2.1	2.7	600	3.3	3.9	50	10	1	-3.5	0	450
BZX84C3V3LT1, G	Z14	3.1	3.3	3.5	95	2.3	2.9	600	3.6	4.2	40	5	1	-3.5	0	450
BZX84C3V6LT1, G	Z15	3.4	3.6	3.8	90	2.7	3.3	600	3.9	4.5	40	5	1	-3.5	0	450
BZX84C3V9LT1, G	Z16	3.7	3.9	4.1	90	2.9	3.5	600	4.1	4.7	30	3	1	-3.5	-2.5	450
BZX84C4V3LT1, G	W9	4	4.3	4.6	90	3.3	4	600	4.4	5.1	30	3	1	-3.5	0	450
<b>BZX84C4V7LT1, G</b>	<b>Z1</b>	<b>4.4</b>	<b>4.7</b>	<b>5</b>	<b>80</b>	<b>3.7</b>	<b>4.7</b>	<b>500</b>	<b>4.5</b>	<b>5.4</b>	<b>15</b>	<b>3</b>	<b>2</b>	<b>-3.5</b>	<b>0.2</b>	<b>260</b>
<b>BZX84C5V1LT1, G</b>	<b>Z2</b>	<b>4.8</b>	<b>5.1</b>	<b>5.4</b>	<b>60</b>	<b>4.2</b>	<b>5.3</b>	<b>480</b>	<b>5</b>	<b>5.9</b>	<b>15</b>	<b>2</b>	<b>2</b>	<b>-2.7</b>	<b>1.2</b>	<b>225</b>
<b>BZX84C5V6LT1, G</b>	<b>Z3</b>	<b>5.2</b>	<b>5.6</b>	<b>6</b>	<b>40</b>	<b>4.8</b>	<b>6</b>	<b>400</b>	<b>5.2</b>	<b>6.3</b>	<b>10</b>	<b>1</b>	<b>2</b>	<b>-2.0</b>	<b>2.5</b>	<b>200</b>
<b>BZX84C6V2LT1, G</b>	<b>Z4</b>	<b>5.8</b>	<b>6.2</b>	<b>6.6</b>	<b>10</b>	<b>5.6</b>	<b>6.6</b>	<b>150</b>	<b>5.8</b>	<b>6.8</b>	<b>6</b>	<b>3</b>	<b>4</b>	<b>0.4</b>	<b>3.7</b>	<b>185</b>
BZX84C6V8LT1, G	Z5	6.4	6.8	7.2	15	6.3	7.2	80	6.4	7.4	6	2	4	1.2	4.5	155
BZX84C7V5LT1, G	Z6	7	7.5	7.9	15	6.9	7.9	80	7	8	6	1	5	2.5	5.3	140
BZX84C8V2LT1, G	Z7	7.7	8.2	8.7	15	7.6	8.7	80	7.7	8.8	6	0.7	5	3.2	6.2	135
BZX84C9V1LT1, G	Z8	8.5	9.1	9.6	15	8.4	9.6	100	8.5	9.7	8	0.5	6	3.8	7.0	130
BZX84C10LT1, G	Z9	9.4	10	10.6	20	9.3	10.6	150	9.4	10.7	10	0.2	7	4.5	8.0	130
BZX84C11LT1, G	Y1	10.4	11	11.6	20	10.2	11.6	150	10.4	11.8	10	0.1	8	5.4	9.0	130
<b>BZX84C12LT1, G</b>	<b>Y2</b>	<b>11.4</b>	<b>12</b>	<b>12.7</b>	<b>25</b>	<b>11.2</b>	<b>12.7</b>	<b>150</b>	<b>11.4</b>	<b>12.9</b>	<b>10</b>	<b>0.1</b>	<b>8</b>	<b>6.0</b>	<b>10.0</b>	<b>130</b>
BZX84C13LT1, G	Y3	12.4	13	14.1	30	12.3	14	170	12.5	14.2	15	0.1	8	7.0	11.0	120
BZX84C15LT1, G	Y4	13.8	15	15.6	30	13.7	15.5	200	13.9	15.7	20	0.05	10.5	9.2	13.0	110
BZX84C16LT1, G	Y5	15.3	16	17.1	40	15.2	17	200	15.4	17.2	20	0.05	11.2	10.4	14.0	105
<b>BZX84C18LT1, G</b>	<b>Y6</b>	<b>16.8</b>	<b>18</b>	<b>19.1</b>	<b>45</b>	<b>16.7</b>	<b>19</b>	<b>225</b>	<b>16.9</b>	<b>19.2</b>	<b>20</b>	<b>0.05</b>	<b>12.6</b>	<b>12.4</b>	<b>16.0</b>	<b>100</b>
BZX84C20LT1, G	Y7	18.8	20	21.2	55	18.7	21.1	225	18.9	21.4	20	0.05	14	14.4	18.0	85
BZX84C22LT1, G	Y8	20.8	22	23.3	55	20.7	23.2	250	20.9	23.4	25	0.05	15.4	16.4	20.0	85
BZX84C24LT1, G	Y9	22.8	24	25.6	70	22.7	25.5	250	22.9	25.7	25	0.05	16.8	18.4	22.0	80
Device	Device Marking	V <sub>Z1</sub> Below @ I <sub>ZT1</sub> = 2 mA			Z <sub>ZT1</sub> Below @ I <sub>ZT1</sub> = 2 mA	V <sub>Z2</sub> Below @ I <sub>ZT2</sub> = 0.1 mA		Z <sub>ZT2</sub> Below @ I <sub>ZT2</sub> = 0.5 mA	V <sub>Z3</sub> Below @ I <sub>ZT3</sub> = 10 mA		Z <sub>ZT3</sub> Below @ I <sub>ZT3</sub> = 10 mA	Max Reverse Leakage Current		θ <sub>VZ</sub> (mV/k) Below @ I <sub>ZT1</sub> = 2 mA		C (pF) @ V <sub>R</sub> = 0 f = 1 MHz
		Min	Nom	Max		Min	Max		Min	Max		I <sub>R</sub> (μA)	V <sub>R</sub> (V)	Min	Max	
BZX84C27LT1, G	Y10	25.1	27	28.9	80	25	28.9	300	25.2	29.3	45	0.05	18.9	21.4	25.3	70
BZX84C30LT1, G	Y11	28	30	32	80	27.8	32	300	28.1	32.4	50	0.05	21	24.4	29.4	70
BZX84C33LT1, G	Y12	31	33	35	80	30.8	35	325	31.1	35.4	55	0.05	23.1	27.4	33.4	70
BZX84C36LT1, G	Y13	34	36	38	90	33.8	38	350	34.1	38.4	60	0.05	25.2	30.4	37.4	70
BZX84C39LT1, G	Y14	37	39	41	130	36.7	41	350	37.1	41.5	70	0.05	27.3	33.4	41.2	45
BZX84C43LT1, G	Y15	40	43	46	150	39.7	46	375	40.1	46.5	80	0.05	30.1	37.6	46.6	40
BZX84C47LT1, G	Y16	44	47	50	170	43.7	50	375	44.1	50.5	90	0.05	32.9	42.0	51.8	40
BZX84C51LT1, G	Y17	48	51	54	180	47.6	54	400	48.1	54.6	100	0.05	35.7	46.6	57.2	40
BZX84C56LT1, G	Y18	52	56	60	200	51.5	60	425	52.1	60.8	110	0.05	39.2	52.2	63.8	40
BZX84C62LT1, G	Y19	58	62	66	215	57.4	66	450	58.2	67	120	0.05	43.4	58.8	71.6	35
BZX84C68LT1, G	Y20	64	68	72	240	63.4	72	475	64.2	73.2	130	0.05	47.6	65.6	79.8	35
BZX84C75LT1, G	Y21	70	75	79	255	69.4	79	500	70.3	80.2	140	0.05	52.5	73.4	88.6	35

3. Zener voltage is measured with a pulse test current I<sub>Z</sub> at an ambient temperature of 25°C.

\* The "G" suffix indicates Pb-Free package available.

## BZX84B4V7LT1, BZX84C2V4LT1 Series

### ELECTRICAL CHARACTERISTICS - BZX84BxxxL (Tight Tolerance Series)

(Pinout: 1-Anode, 2-No Connection, 3-Cathode) ( $T_A = 25^\circ\text{C}$  unless otherwise noted,  $V_F = 0.90\text{ V Max. @ } I_F = 10\text{ mA}$ )

Device	Device Marking	$V_Z$ (Volts) @ $I_{ZT} = 5\text{ mA}$ (Note 4)			$Z_{ZT} (\Omega)$ @ $I_{ZT} = 5\text{ mA}$ (Note 4)	Max Reverse Leakage Current		$\theta_{VZ}$ (mV/k) @ $I_{ZT} = 5\text{ mA}$		C (pF) @ $V_R = 0$ , f = 1 MHz
						$I_R$	$V_R$			
		Min	Nom	Max	Max	$\mu\text{A}$	@ Volts	Min	Max	
BZX84B4V7LT1, G	T10	4.61	4.7	4.79	80	3	2	-3.5	0.2	260
BZX84B5V1LT1, G	T11	5.00	5.1	5.20	60	2	2	-2.7	1.2	225
BZX84B5V6LT1, G	T12	5.49	5.6	5.71	40	1	2	-2	2.5	200
BZX84B6V2LT1, G	T13	6.08	6.2	6.32	10	3	4	0.4	3.7	185
BZX84B6V8LT1, G	T14	6.66	6.8	6.94	15	2	4	1.2	4.5	155
BZX84B7V5LT1, G	T15	7.35	7.5	7.65	15	1	5	2.5	5.3	140
BZX84B8V2LT1, G	T16	8.04	8.2	8.36	15	0.7	5	3.2	6.2	135
BZX84B9V1LT1, G	T17	8.92	9.1	9.28	15	0.5	6	3.8	7	130
BZX84B12LT1, G	T18	11.8	12	12.2	25	0.1	8	6	10	130
BZX84B15LT1, G	T22	14.7	15	15.3	30	0.05	10.5	9.2	13	110
BZX84B16LT1, G	T19	15.7	16	16.3	40	0.05	11.2	10.4	14	105
BZX84B18LT1, G	T20	17.6	18	18.4	45	0.05	12.6	12.4	16	100
BZX84B22LT1, G	T24	21.6	22	22.4	55	0.05	15.4	16.4	20	85
BZX84B24LT1, G	T25	23.5	24	24.5	70	0.05	16.8	18.4	22	80

4. Zener voltage is measured with a pulse test current  $I_Z$  at an ambient temperature of  $25^\circ\text{C}$ .

\* The "G" suffix indicates Pb-Free package available.

# BZX84B4V7LT1, BZX84C2V4LT1 Series

## TYPICAL CHARACTERISTICS

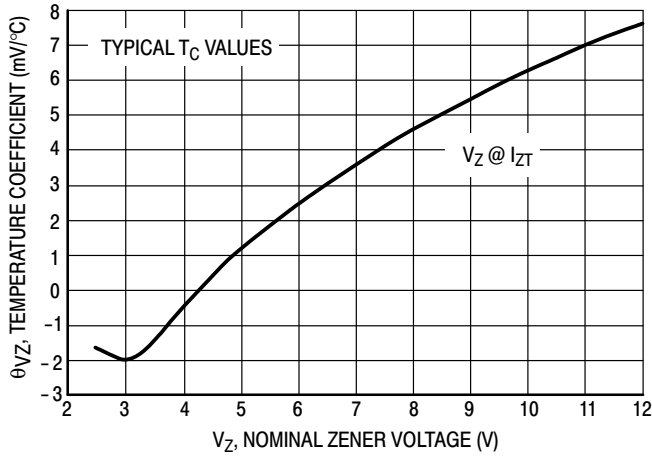

**Figure 1. Temperature Coefficients  
(Temperature Range -55°C to +150°C)**

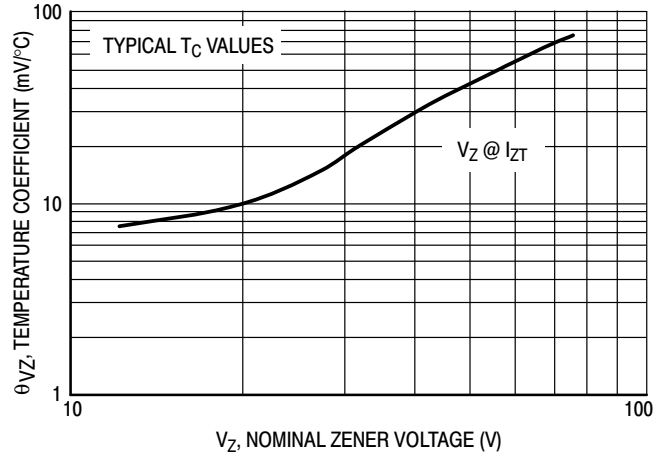

**Figure 2. Temperature Coefficients  
(Temperature Range -55°C to +150°C)**

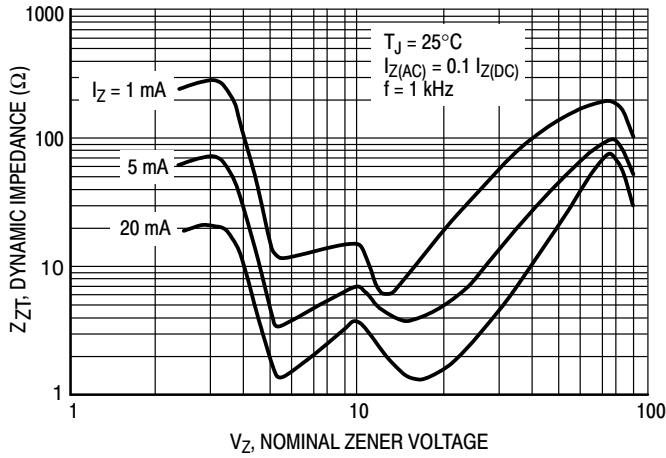

**Figure 3. Effect of Zener Voltage on  
Zener Impedance**

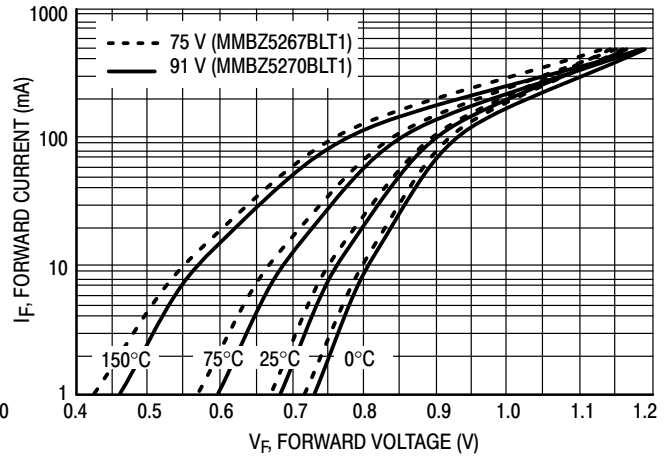

**Figure 4. Typical Forward Voltage**

# BZX84B4V7LT1, BZX84C2V4LT1 Series

## TYPICAL CHARACTERISTICS



Figure 5. Typical Capacitance

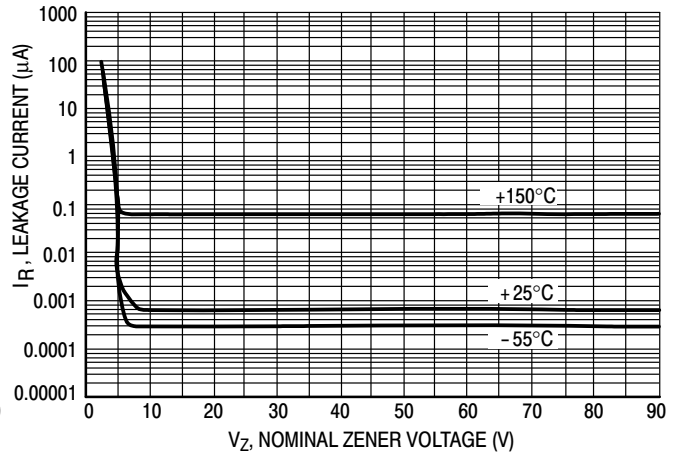

Figure 6. Typical Leakage Current

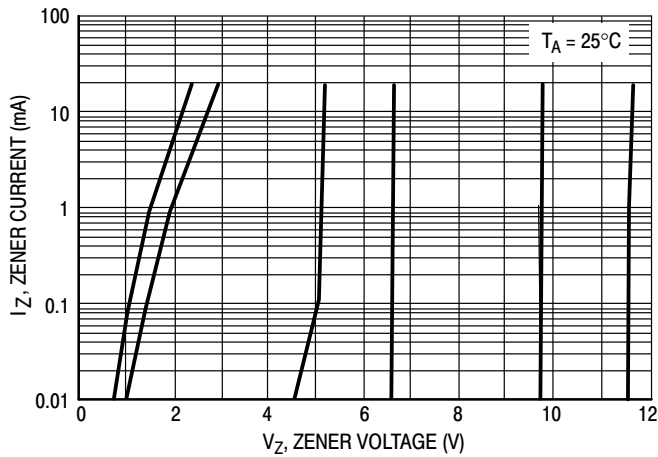

Figure 7. Zener Voltage versus Zener Current  
( $V_Z$  Up to 12 V)

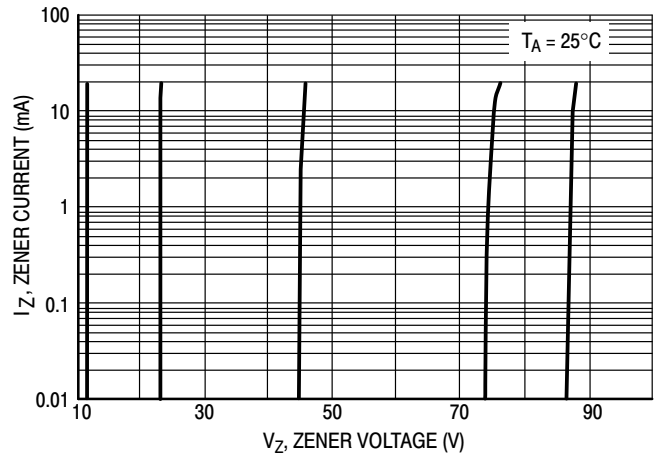
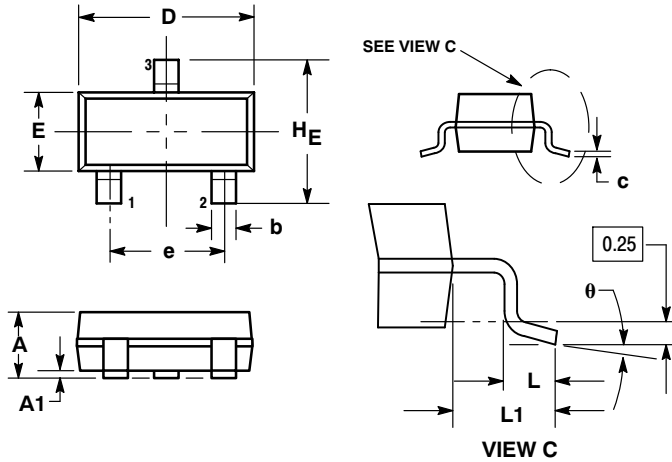

Figure 8. Zener Voltage versus Zener Current  
(12 V to 91 V)

# BZX84B4V7LT1, BZX84C2V4LT1 Series

## PACKAGE DIMENSIONS

SOT-23 (TO-236)  
CASE 318-08  
ISSUE AN



- NOTES:
1. DIMENSIONING AND TOLERANCING PER ANSI Y14.5M, 1982.
  2. CONTROLLING DIMENSION: INCH.
  3. MAXIMUM LEAD THICKNESS INCLUDES LEAD FINISH THICKNESS. MINIMUM LEAD THICKNESS IS THE MINIMUM THICKNESS OF BASE MATERIAL.
  4. 318-01 THRU -07 AND -09 OBSOLETE, NEW STANDARD 318-08.

DIM	MILLIMETERS			INCHES		
	MIN	NOM	MAX	MIN	NOM	MAX
A	0.89	1.00	1.11	0.035	0.040	0.044
A1	0.01	0.06	0.10	0.001	0.002	0.004
b	0.37	0.44	0.50	0.015	0.018	0.020
c	0.09	0.13	0.18	0.003	0.005	0.007
D	2.80	2.90	3.04	0.110	0.114	0.120
E	1.20	1.30	1.40	0.047	0.051	0.055
e	1.78	1.90	2.04	0.070	0.075	0.081
L	0.10	0.20	0.30	0.004	0.008	0.012
L1	0.35	0.54	0.69	0.014	0.021	0.029
HE	2.10	2.40	2.64	0.083	0.094	0.104

- STYLE 8:
1. ANODE
  2. NO CONNECTION
  3. CATHODE

## SOLDERING FOOTPRINT\*

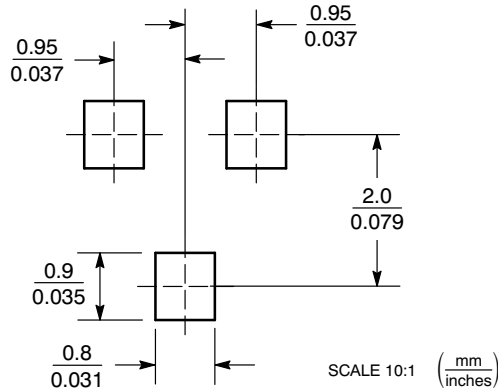

\*For additional information on our Pb-Free strategy and soldering details, please download the ON Semiconductor Soldering and Mounting Techniques Reference Manual, SOLDERRM/D.

ON Semiconductor and are registered trademarks of Semiconductor Components Industries, LLC (SCILLC). SCILLC reserves the right to make changes without further notice to any products herein. SCILLC makes no warranty, representation or guarantee regarding the suitability of its products for any particular purpose, nor does SCILLC assume any liability arising out of the application or use of any product or circuit, and specifically disclaims any and all liability, including without limitation special, consequential or incidental damages. "Typical" parameters which may be provided in SCILLC data sheets and/or specifications can and do vary in different applications and actual performance may vary over time. All operating parameters, including "Typicals" must be validated for each customer application by customer's technical experts. SCILLC does not convey any license under its patent rights nor the rights of others. SCILLC products are not designed, intended, or authorized for use as components in systems intended for surgical implant into the body, or other applications intended to support or sustain life, or for any other application in which the failure of the SCILLC product could create a situation where personal injury or death may occur. Should Buyer purchase or use SCILLC products for any such unintended or unauthorized application, Buyer shall indemnify and hold SCILLC and its officers, employees, subsidiaries, affiliates, and distributors harmless against all claims, costs, damages, and expenses, and reasonable attorney fees arising out of, directly or indirectly, any claim of personal injury or death associated with such unintended or unauthorized use, even if such claim alleges that SCILLC was negligent regarding the design or manufacture of the part. SCILLC is an Equal Opportunity/Affirmative Action Employer. This literature is subject to all applicable copyright laws and is not for resale in any manner.

## PUBLICATION ORDERING INFORMATION

LITERATURE FULFILLMENT:  
Literature Distribution Center for ON Semiconductor  
P.O. Box 5163, Denver, Colorado 80217 USA  
Phone: 303-675-2175 or 800-344-3860 Toll Free USA/Canada  
Fax: 303-675-2176 or 800-344-3867 Toll Free USA/Canada  
Email: orderlit@onsemi.com

N. American Technical Support: 800-282-9855 Toll Free  
USA/Canada  
Europe, Middle East and Africa Technical Support:  
Phone: 421 33 790 2910  
Japan Customer Focus Center  
Phone: 81-3-5773-3850

ON Semiconductor Website: [www.onsemi.com](http://www.onsemi.com)

Order Literature: <http://www.onsemi.com/orderlit>

For additional information, please contact your local Sales Representative