

# Notice for TAIYO YUDEN products

Please read this notice before using the TAIYO YUDEN products.

## REMINDERS

- Product information in this catalog is as of October 2010. All of the contents specified herein are subject to change without notice due to technical improvements, etc. Therefore, please check for the latest information carefully before practical application or usage of the Products.

Please note that Taiyo Yuden Co., Ltd. shall not be responsible for any defects in products or equipment incorporating such products, which are caused under the conditions other than those specified in this catalog or individual specification.

- Please contact Taiyo Yuden Co., Ltd. for further details of product specifications as the individual specification is available.
- Please conduct validation and verification of products in actual condition of mounting and operating environment before commercial shipment of the equipment.
- All electronic components or functional modules listed in this catalog are developed, designed and intended for use in general electronics equipment.(for AV, office automation, household, office supply, information service, telecommunications, (such as mobile phone or PC) etc.). Before incorporating the components or devices into any equipment in the field such as transportation,( automotive control, train control, ship control), transportation signal, disaster prevention, medical, public information network (telephone exchange, base station) etc. which may have direct influence to harm or injure a human body, please contact Taiyo Yuden Co., Ltd. for more detail in advance. Do not incorporate the products into any equipment in fields such as aerospace, aviation, nuclear control, submarine system, military, etc. where higher safety and reliability are especially required.

In addition, even electronic components or functional modules that are used for the general electronic equipment, if the equipment or the electric circuit require high safety or reliability function or performances, a sufficient reliability evaluation check for safety shall be performed before commercial shipment and moreover, due consideration to install a protective circuit is strongly recommended at customer's design stage.

- The contents of this catalog are applicable to the products which are purchased from our sales offices or distributors (so called "TAIYO YUDEN' s official sales channel").  
It is only applicable to the products purchased from any of TAIYO YUDEN' s official sales channel.
- Please note that Taiyo Yuden Co., Ltd. shall have no responsibility for any controversies or disputes that may occur in connection with a third party's intellectual property rights and other related rights arising from your usage of products in this catalog. Taiyo Yuden Co., Ltd. grants no license for such rights.

- Caution for export  
Certain items in this catalog may require specific procedures for export according to "Foreign Exchange and Foreign Trade Control Law" of Japan, "U.S. Export Administration Regulations", and other applicable regulations. Should you have any question or inquiry on this matter, please contact our sales staff.

# MULTILAYER FILTER



REFLOW

## FEATURES

- Compact and Low-profile
- Low loss and high attenuation
- Stable temperature characteristics

## APPLICATIONS

- Bluetooth® module, Wireless LAN, Digital TV

## ORDERING CODE

F | I | △ | 2 | 1 | 2 | B | 2 | 4 | 5 | 0 | 2 | 5 | - | T

<b>1</b> Device code	<b>2</b> Electrode code	<b>3</b> Dimensions code [mm]	<b>4</b> Special Code	<b>5</b> Frequency [MHz]	<b>6</b> Spec Code	<b>7</b> Packaging
FI Filters for High Frequency	△ With Plating △=Blank space	212 2.0×1.25 168 1.6×0.8 105 1.0×0.5	B Band Pass Filter L Low Pass Filter C Balance Filter P Diplexer T Balun D Dual Filter	example 2450 2400~2500 0620 470~770	01~ Individual Spec	-T Tape & Reel

## EXTERNAL DIMENSIONS/STANDARD QUANTITY

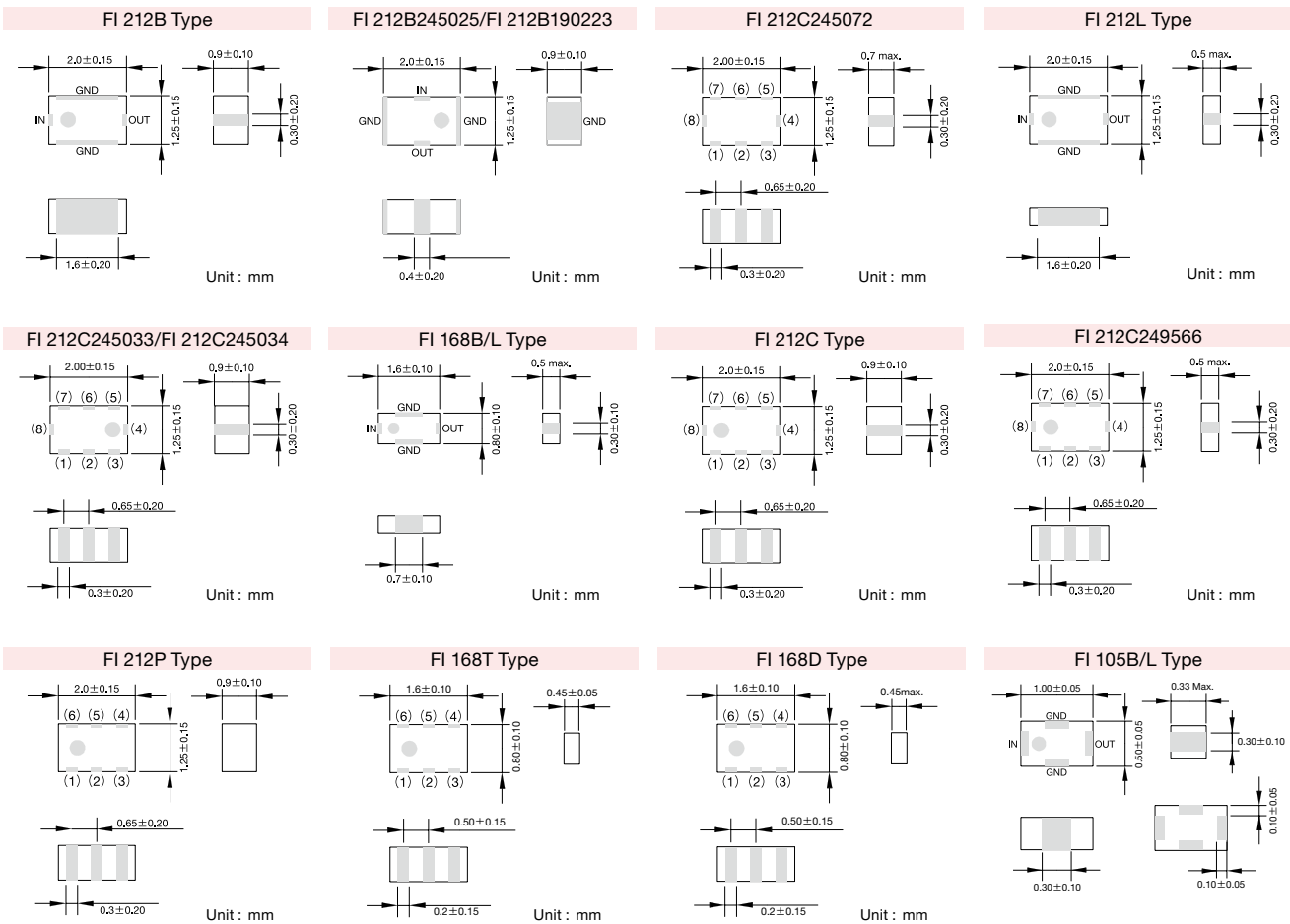

	FI 212C2450XX	FI 212C245041	FI 212C245051	FI 212C249566	FI 212P245003	FI 212P245003/ FI 212P089208	FI 212P089213	FI 168T578717	FI 168D087018	Type	Standard Quantity [pcs] Embossed Tape
(1)	Balanced	Balanced	Balanced	Balanced	GND	GND	GND	Unbalance	High Band IN	212B	3000
(2)	GND	Balanced	GND	GND	Common	Common Port	Common Port	GND	GND	212L	
(3)	Balanced	GND	Balanced	Balanced	GND	GND	GND	NC	Low Band IN	212C	
(4)	GND	GND	GND	GND	HIGH Band	Low Band	Low Band	Balanced	Low Band OUT	212P	4000
(5)	Unbalance	NC	Unbalance	Unbalance	GND	GND	GND	GND	GND	168B	
(6)	DC	DC	NC	NC or DC	Low Band	High Band	High Band	Balanced	High Band OUT	168L	
(7)	NC	Unbalance	NC	NC	-	-	-	-	-	168T	
(8)	GND	GND	GND	GND	-	-	-	-	-	168D	10000
										105B	
										105L	

\* This catalog contains the typical specification only due to the limitation of space. When you consider the purchase of our products, please check our specification. For details of each product (characteristics graph, reliability information, precautions for use, and so on), see our Web site (<http://www.ty-top.com/>) or CD catalogs.

## PART NUMBERS

### Multi-layer band pass filters

Applications	External dimensions	Ordering code	Notes
2.4GHz W-LAN Bluetooth	2.0×1.25×1.0 max.	FI 212B245025/FI 212B245026/FI 212B245027/FI 212B245029	
	1.6×0.8×0.5 max.	FI 168B245001/FI 168B245028	
	1.0×0.5×0.33max.	FI 105B245024	
WiMAX	1.6×0.8×0.5 max.	FI 168B250065	
UWB	2.0×1.25×1.0 max.	FI 212B396001	WiMedia Band group 1
	2.0×1.25×1.0 max.	FI 212B448802	WiMedia Band group 1 TFC 7
PHS	2.0×1.25×1.0 max.	FI 212B190223	

### Multi-layer low pass filters

Applications	External dimensions	Ordering code	Notes
Digital TV	2.0×1.25×0.5 max.	FI 212L062002	for ISDB-T
	2.0×1.25×0.5 max.	FI 212L062003	for ISDB-T
	2.0×1.25×0.5 max.	FI 212L062009	for ISDB-T
	1.6×0.8×0.45 max.	FI 168L062005	Thickness 0.45 mm max.
WiMAX	1.6×0.8×0.45 max.	FI 168L259764	Thickness 0.45 mm max.
	1.0×0.5×0.33 max.	FI 105L250014	Thickness 0.33 mm max.
Other	1.6×0.8×0.45 max.	FI 168D087018	Dual band LPF

### Multi-layer diplexer

Applications	External dimensions	Ordering code	Notes
W-LAN	2.0×1.25×1.0 max.	FI 212P245003	
Other	2.0×1.25×1.0 max.	FI 212P089208	For Cellular
Other	2.0×1.25×1.0 max.	FI 212P089213	For Cellular

### Multi-layer balance filters

Applications	External dimensions	Ordering code	Notes
Bluetooth	2.0×1.25×1.0 max.	FI 212C245032	Conjugated match to CSR BC4
	2.0×1.25×1.0 max.	FI 212C245033	Conjugated match to CSR BC3
	2.0×1.25×1.0 max.	FI 212C245034	Conjugated match to CSR BC4-BGA
	2.0×1.25×1.0 max.	FI 212C245035	Conjugated match to CSR BC5
	2.0×1.25×1.0 max.	FI 212C245036	Conjugated match to CSR BC5
	2.0×1.25×1.0 max.	FI 212C245041	Conjugated match to BRFF6150 & BRFF6300-BGA
	2.0×1.25×1.0 max.	FI 212C245051	Conjugated match to STLC2500C-D
	2.0×1.25×0.7 max.	FI 212C245072	Conjugated match to CSR BC5FM, BC6ROM
WiMAX	2.0×1.25×0.5 max.	FI 212C249566	Thickness 0.5 mm max.

### Multi-layer Balun

Applications	External dimensions	Ordering code	Notes
その他	1.6×0.8×0.5 max.	FI 168T578717	Thickness 0.5 mm max.

## ELECTRICAL CHARACTERISTICS·TYPICAL CHARACTERISTICS

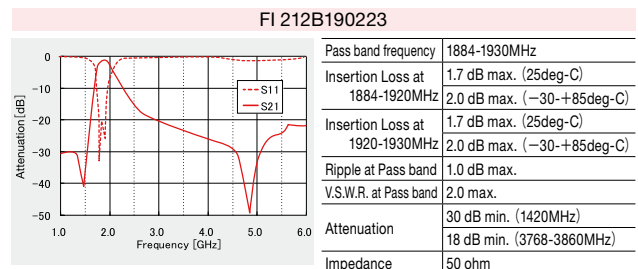
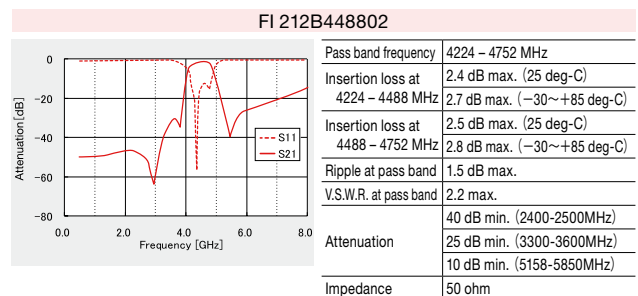
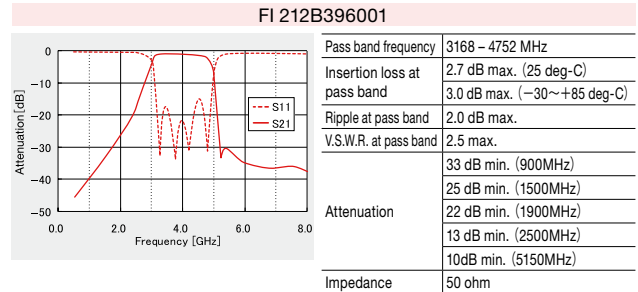
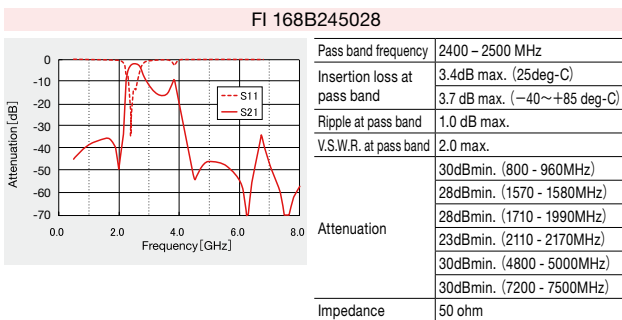
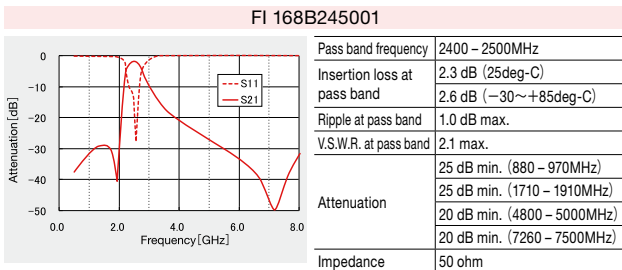

\* This catalog contains the typical specification only due to the limitation of space. When you consider the purchase of our products, please check our specification. For details of each product (characteristics graph, reliability information, precautions for use, and so on), see our Web site (<http://www.ty-top.com/>) or CD catalogs.

FI 212L062002

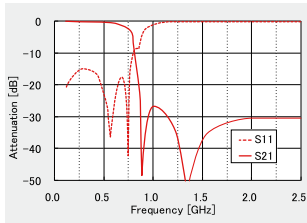

Pass band frequency	470 - 770 MHz
Insertion loss at 470-600MHz	0.9 dB max. (25 deg-C)
Insertion loss at 600-710MHz	1.1 dB max. (-30~+85 deg-C)
Insertion loss at 710-770MHz	1.5 dB max. (25 deg-C)
Insertion loss at 710-770MHz	1.7 dB max. (-30~+85 deg-C)
Insertion loss at 710-770MHz	3.4 dB max. (25 deg-C)
Insertion loss at 710-770MHz	3.7 dB max. (-30~+85 deg-C)
Ripple at 470 - 710 MHz	1.2 dB max.
V.S.W.R. at 470 - 710 MHz	2.0 max.
	25 dB min. (888 - 925 MHz)
	25 dB min. (940 - 960 MHz)
Attenuation	27 dB min. (1429 - 1453 MHz)
	26 dB min. (1920 - 1980 MHz)
	26 dB min. (2400 - 2500 MHz)
Impedance	50 ohm

FI 212L062003

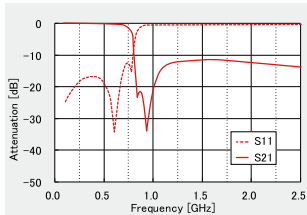

Pass band frequency	470 - 770 MHz
Insertion loss at 470 - 600MHz	0.7 dB max. (25 deg-C)
Insertion loss at 470 - 600MHz	0.9 dB max. (-30~+85 deg-C)
Insertion loss at 600 - 710MHz	1.5 dB max. (25 deg-C)
Insertion loss at 600 - 710MHz	1.7 dB max. (-30~+85 deg-C)
Insertion loss at 710 - 770MHz	3.3 dB max. (25 deg-C)
Insertion loss at 710 - 770MHz	3.7 dB max. (-30~+85 deg-C)
Ripple at 470 - 710 MHz	1.2 dB max.
V.S.W.R. at 470 - 710 MHz	2.5 max.
	15 dB min. (830 - 840 MHz) (25 deg-C)
	11 dB min. (830 - 840 MHz) (-30~+85 deg-C)
Attenuation	15 dB min. (888 - 925 MHz)
	15 dB min. (940 - 960 MHz)
	7 dB min. (1429 - 1453 MHz)
	8 dB min. (1920 - 1980 MHz)
	8 dB min. (2400 - 2500 MHz)
Impedance	50 ohm

FI 212L062009

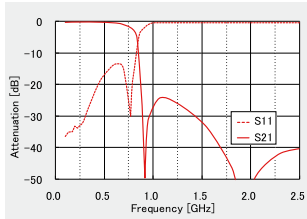

Pass band frequency	470 - 806 MHz
Insertion loss at 470 - 710 MHz	1.6 dB max. (25 deg-C)
Insertion loss at 470 - 710 MHz	1.8 dB max. (-30~+85 deg-C)
Insertion loss at 710 - 750 MHz	2.2 dB max. (25 deg-C)
Insertion loss at 710 - 750 MHz	2.5 dB max. (-30~+85 deg-C)
Insertion loss at 750 - 806 MHz	5.2 dB max. (25 deg-C)
Insertion loss at 750 - 806 MHz	6.0 dB max. (-30~+85 deg-C)
Ripple at 470 - 710 MHz	1.2 dB max.
V.S.W.R. at 470 - 710 MHz	2.2 max.
	20 dB min. (880 - 915 MHz) (25 deg-C)
Attenuation	17 dB min. (880 - 915 MHz) (-30~+85 deg-C)
	30 dB min. (1710-1910 MHz)
Impedance	50 ohm

FI 168L062005

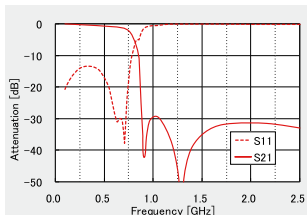

Pass band frequency	470 - 770 MHz
Insertion loss at 470-600MHz	1.2 dB max. (25 deg-C)
Insertion loss at 470-600MHz	1.3 dB max. (-30~+85 deg-C)
Insertion loss at 600-710MHz	2.2 dB max. (25 deg-C)
Insertion loss at 600-710MHz	2.4 dB max. (-30~+85 deg-C)
Insertion loss at 710-770MHz	4.0 dB max. (25 deg-C)
Insertion loss at 710-770MHz	4.4 dB max. (-30~+85 deg-C)
Ripple at 470 - 710 MHz	1.4 dB max.
V.S.W.R.	2.0 max. (470 - 710 MHz)
	2.5 max. (710 - 770 MHz)
	25 dB min. (888 - 925 MHz) (25 deg-C)
	21 dB min. (888 - 925 MHz) (-30~+85 deg-C)
Attenuation	25 dB min. (940 - 960 MHz)
	27 dB min. (1429 - 1453 MHz)
	26 dB min. (1920 - 1980 MHz)
	26 dB min. (2400 - 2500 MHz)
Impedance	50 ohm

FI 168L259764

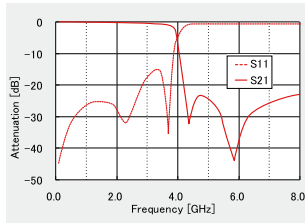

Pass band frequency	470 - 770 MHz
Pass band frequency	2300 - 2700 MHz
Insertion loss at 470-770MHz	0.5 dB max. (25 deg-C)
Insertion loss at 470-770MHz	0.6 dB max. (-30~+85 deg-C)
Insertion loss at 2300-2700MHz	0.5 dB max. (25 deg-C)
Insertion loss at 2300-2700MHz	0.6 dB max. (-30~+85 deg-C)
Ripple at 470 - 770 MHz	0.3 dB max.
Ripple at 2300 - 2700 MHz	0.3 dB max.
V.S.W.R. at 470 - 770 MHz	2.0 max.
V.S.W.R. at 2300 - 2700 MHz	2.0 max.
Attenuation	20 dB min. (4600 - 5400 MHz)
	20 dB min. (6900 - 8100 MHz)
Impedance	50 ohm

FI 168D087018

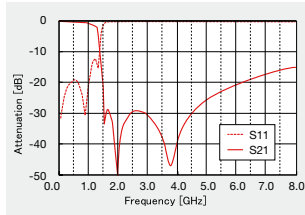

Low band	
Pass band frequency	824 - 915 MHz
Insertion loss at 824 - 915 MHz	0.6 dB max. (-20 to +85 Deg.C)
V.S.W.R. at 824 - 915 MHz	1.5 max.
Attenuation	25 dB min. (1648-1830MHz)
	25 dB min. (2472-2745MHz)
Impedance	50 ohm
High band	
Pass band frequency	1710 - 1910 MHz
Insertion loss at 1710 - 1910 MHz	0.6 dB max. (-20 to +85 Deg.C)
V.S.W.R. at 824 - 915 MHz	1.5 max.
Attenuation	25 dB min. (3420-3820MHz)
	25 dB min. (5130-5730MHz)
Impedance	50 ohm
Isolation	
In to In/Out to Out	27 dB min. (824-915MHz)
	30 dB min. (1710-1910MHz)
In to Out	30 dB min. (824-915MHz)
	30 dB min. (1710-1910MHz)

FI 212C245032

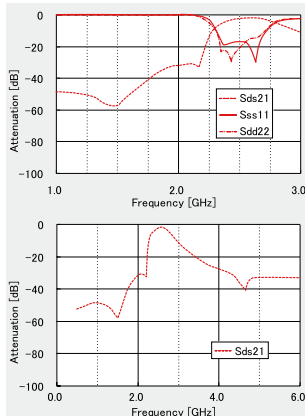

Pass band frequency	2400-2500MHz
Insertion loss at pass band	3.7 dB (25deg-C)
Insertion loss at pass band	4.0 dB (-30~+85deg-C)
Ripple at pass band	1.0 dB max.
Unbalanced port V.S.W.R. at pass band	2.0 max.
Balanced port V.S.W.R. at pass band	2.0 max.
Amplitude Imbalance at pass band	2.0 dB max.
Phase Imbalance at pass band	180 +/- 10 deg
Attenuation	35 dB min. (880-960MHz)
	20 dB min. (1710-1990MHz)
	20 dB min. (1990-2170MHz)
	20 dB min. (4800-5000MHz)
Unbalanced Port Impedance	50 ohm
Balanced Port Impedance	Conjugated match to CSR BC4

\* This catalog contains the typical specification only due to the limitation of space. When you consider the purchase of our products, please check our specification. For details of each product (characteristics graph, reliability information, precautions for use, and so on), see our Web site (<http://www.ty-top.com/>) or CD catalogs.

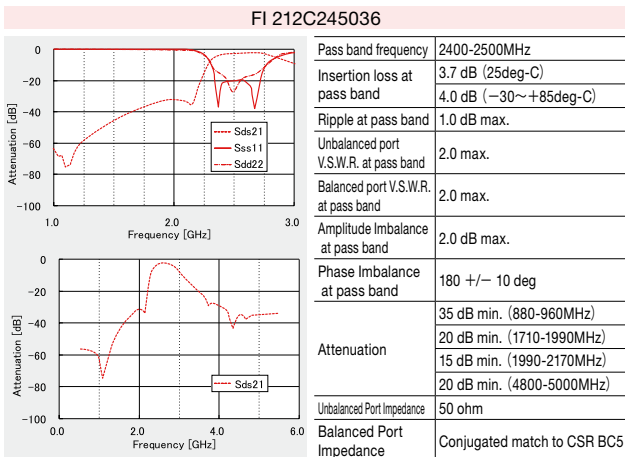
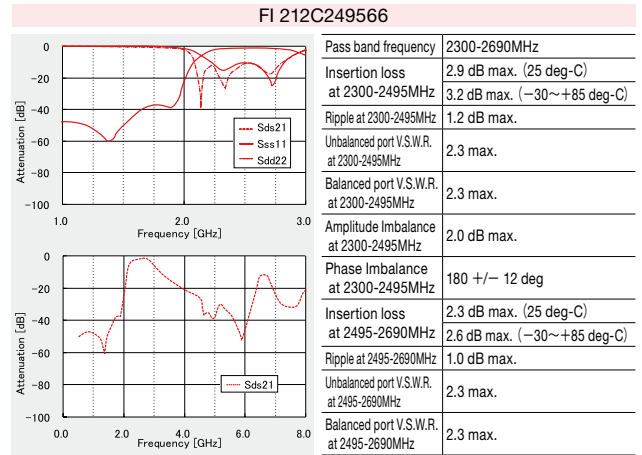
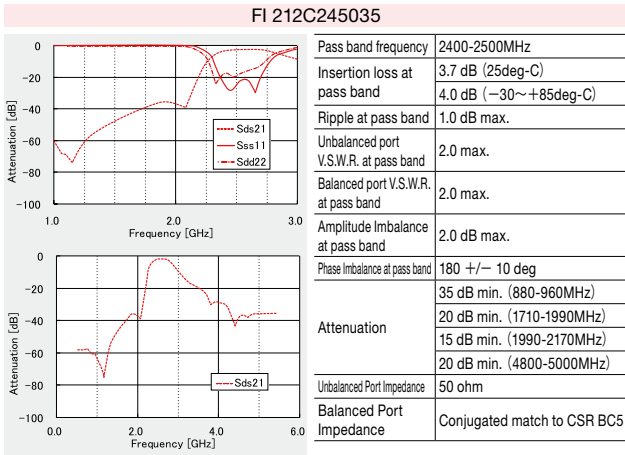
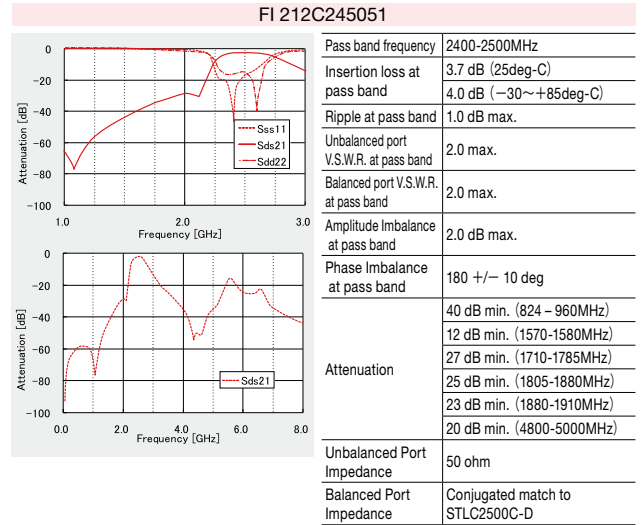
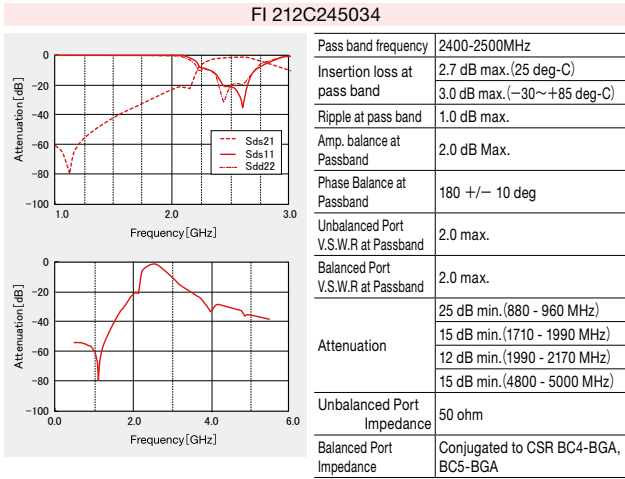
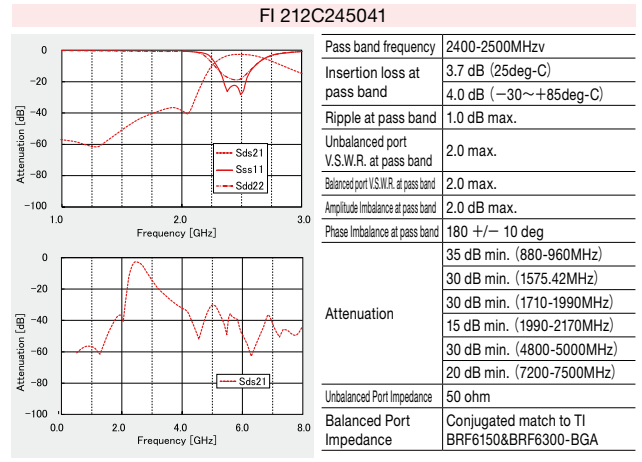
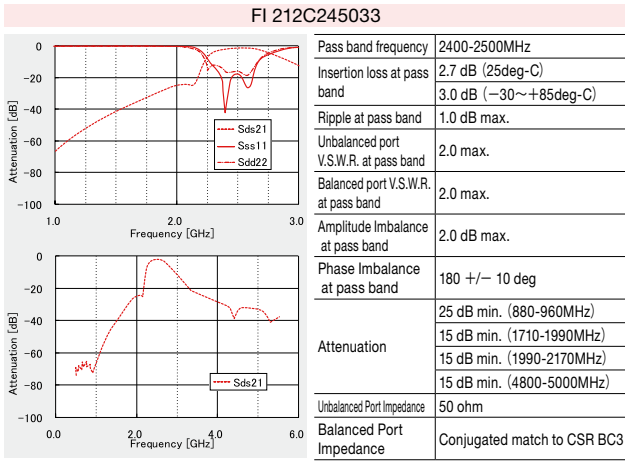

\* This catalog contains the typical specification only due to the limitation of space. When you consider the purchase of our products, please check our specification. For details of each product (characteristics graph, reliability information, precautions for use, and so on), see our Web site (<http://www.ty-top.com/>) or CD catalogs.

FI 212P245003

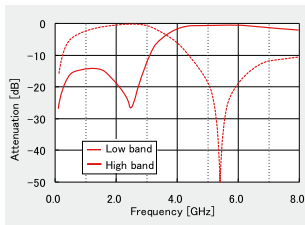

Low band	
Pass band frequency	2400-2500MHz
Insertion loss at 2400-2500MHz	0.5 dB max. (25 deg-C) 0.7 dB max. (-30~+85 deg-C)
V.S.W.R.	2.0 dB max.
Attenuation	14 dB min. (4900-5150MHz) 20 dB min. (5150-5350MHz) 14 dB min. (5470-5825MHz)
High band	
Pass band frequency 1	4900-5150MHz
Pass band frequency 2	5150-5350MHz
Pass band frequency 3	5470-5825MHz
Insertion loss at pass band 1	0.7 dB max. (25 deg-C) 0.9 dB max. (-30~+85 deg-C)
Insertion loss at pass band 2	0.6 dB max. (25 deg-C) 0.8 dB max. (-30~+85 deg-C)
Insertion loss at pass band 3	0.9 dB max. (25 deg-C) 1.0 dB max. (-30~+85 deg-C)
V.S.W.R.	2.0 dB max. (band-1-2) 2.5 dB max. (band-2)
Attenuation	20 dB min. (2400-2500MHz)

FI 212P089208

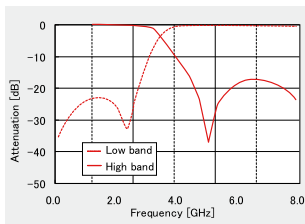

Low band	
Pass band frequency	824 - 960 MHz
Insertion loss at 824 - 960 MHz	0.27 dB max. (+25 Deg.C) 0.32 dB max. (-40 to +85 Deg.C)
V.S.W.R. at 824 - 960 MHz	2.0 max.
Attenuation	13dB min. (1710-2170MHz)
Impedance	50 ohm
High band	
Pass band frequency	1710 - 2170 MHz
Insertion loss at 1710 - 2170 MHz	0.45 dB max. (+25 Deg.C) 0.55 dB max. (-40 to +85 Deg.C)
V.S.W.R. at 824 - 915 MHz	2.0 max.
Attenuation	19dB min. (824-960MHz)
Impedance	50 ohm

FI 212P089213

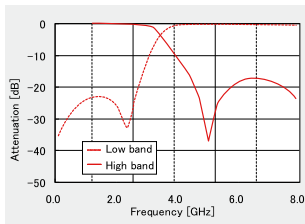

Low band	
Pass band frequency	824 - 960 MHz
Insertion loss at 824 - 960 MHz	0.27 dB max. (+25 Deg.C) 0.32 dB max. (-40 to +85 Deg.C)
V.S.W.R. at 824 - 960 MHz	2.0 max.
Attenuation	13dB min. (1710-2170MHz)
Impedance	50 ohm
High band	
Pass band frequency	1710 - 2170 MHz
Insertion loss at 1710 - 2170 MHz	0.45 dB max. (+25 Deg.C) 0.55 dB max. (-40 to +85 Deg.C)
V.S.W.R. at 824 - 915 MHz	2.0 max.
Attenuation	19dB min. (824-960MHz)
Impedance	50 ohm

FI 105L250014

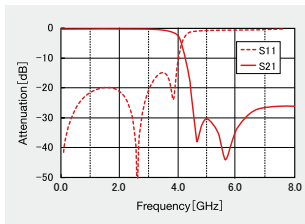

Pass band frequency	2400-2500MHz
Insertion loss at 2400 - 2500 MHz	0.45 dB max. (25 deg-C) 0.55 dB max. (-40~+85 deg-C)
V.S.W.R. at 2400 - 2500 MHz	1.7 max.
Attenuation	21 dB min. (4800 - 5000 MHz) 21 dB min. (7200 - 7500 MHz)
Impedance	50 ohm

FI 212B245025

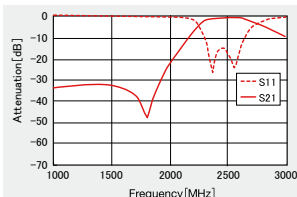

Pass band frequency	2400-2500MHz
Insertion loss at pass band	1.4 dB max. (25 deg-C) 1.7 dB max. (-30~+85 deg-C)
Ripple at pass band	1.0 dB max.
V.S.W.R. at pass band	2.0 max.
Attenuation	30 dB min. (824 - 960 MHz) 30 dB min. (850 MHz) 30 dB min. (900 MHz) 30 dB min. (1800 MHz) 30 dB min. (1900 MHz) 27 dB min. (1710 - 1910 MHz) 20 dB min. (4800 - 5000 MHz) 20 dB min. (5000 MHz)

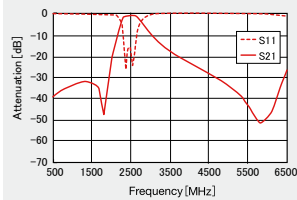

FI 212B245027

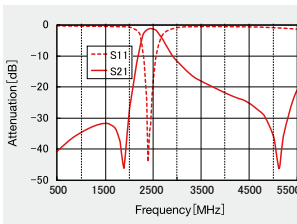

Pass band frequency	2400-2500MHz
Insertion loss at pass band	1.4 dB max. (25 deg-C) 1.7 dB max. (-40~+85 deg-C)
Ripple at pass band	1.0 dB max.
V.S.W.R. at pass band	2.0 max.
Attenuation	30 dB min. (880 - 915 MHz) 30 dB min. (1710 - 1910 MHz) 6 dB min. (2100 - 2170 MHz) 20 dB min. (4800 - 5000 MHz)

FI 168T578717

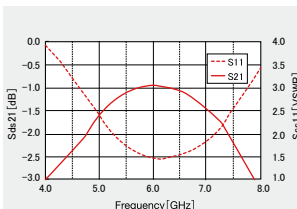

Pass band frequency	5725-5850MHz
Insertion loss at pass band	1.0 dB max. (25 deg-C)
V.S.W.R. at pass band	2.0 max.
Phase balance at pass band	180 +/- 10 deg
Amplitude Imbalance at pass band	1.0 dB max.
Impedance	50 : 100

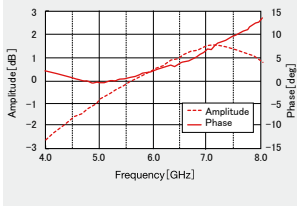

\* This catalog contains the typical specification only due to the limitation of space. When you consider the purchase of our products, please check our specification. For details of each product (characteristics graph, reliability information, precautions for use, and so on), see our Web site (<http://www.ty-top.com/>) or CD catalogs.

FI 105B245024

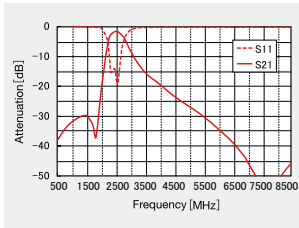

Pass band frequency	2400-2500MHz
Insertion loss at pass band	3.0 dB max. (25 deg-C) 3.3 dB max. (-40~+85 deg-C)
Ripple at pass band	1.0 dB max.
V.S.W.R. at pass band	2.2 max.
Attenuation	25 dB min. (880 - 960 MHz)
	22 dB min. (1710 - 1910 MHz)
	20 dB min. (4800 - 5000 MHz)
	20 dB min. (7200 - 7500 MHz)

FI 212B245026

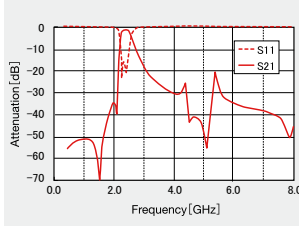

Pass band frequency	2400 - 2500 MHz
Insertion loss at pass band	2.6 dB max. (25 deg-C) 2.9 dB max. (-40~+85 deg-C)
Ripple at pass band	1.0 dB max.
V.S.W.R. at pass band	2.0 max.
Attenuation	40 dB min. (800 - 960 MHz)
	30 dB min. (1710 - 1990 MHz)
	25 dB min. (2110 - 2170 MHz)
	30 dB min. (4800 - 5000 MHz)
	30 dB min. (7200 - 7500 MHz)
Impedance	50 ohm

FI 212B245029

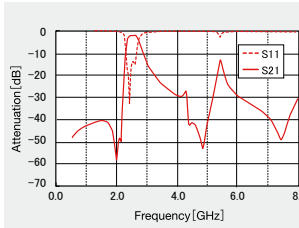

Pass band frequency	2400-2500MHz
Insertion Loss at Pass band	3.0dB max. (25deg-C) 3.3 dB max. (-40~+85 deg-C)
Ripple at Pass band	1.0 dB max.
V.S.W.R. at Pass band	2.0 max.
Attenuation	40dB min. (800-960MHz)
	38dB min. (1570-1580MHz)
	38dB min. (1710-1990MHz)
	30dB min. (2110-2170MHz)
	30dB min. (4800-5000MHz)
	30dB min. (7200-7500MHz)
Impedance	50 ohm

FI 168B250065

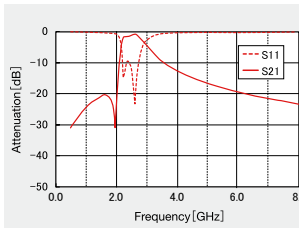

Pass band frequency	2300 - 2700 MHz
Insertion loss at 2300 - 2500 MHz	2.4 dB max. (25 deg-C) 2.6 dB max. (-30~+85 deg-C)
Insertion loss at 2500 - 2700 MHz	2.3 dB max. (25 deg-C) 2.5 dB max. (-30~+85 deg-C)
Ripple at 2300 - 2500 MHz	1.4 dB max.
Ripple at 2500 - 2700 MHz	1.3 dB max.
V.S.W.R. at 2300 - 2500 MHz	2.4 max.
V.S.W.R. at 2500 - 2700 MHz	1.3 max.
Attenuation	15 dB min. (1500 - 2000 MHz)
	10 dB min. (4600 - 8000 MHz)
Impedance	50 ohm

FI 212C245072

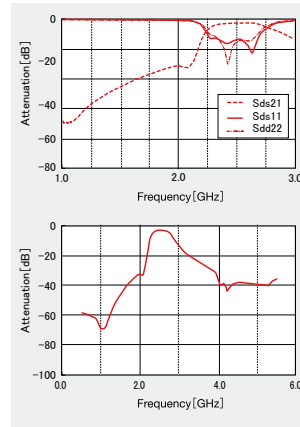

Pass band frequency	2400-2500MHz
Insertion loss at pass band	3.7 dB (25deg-C) 4.0 dB (-30~+85deg-C)
Ripple at pass band	1.0 dB max.
Single ended port V.S.W.R. at pass band	2.2 max.
Balanced port V.S.W.R. at pass band	2.2 max.
Amplitude Imbalance at pass band	2.0 dB max.
Phase Imbalance at pass band	180 +/- 10 deg
Attenuation	35 dB min. (880-960MHz)
	18 dB min. (1710-1990MHz)
	12 dB min. (1990-2170MHz)
	15 dB min. (4800-5000MHz)
Unbalanced Port Impedance	50 ohm
Balanced Port Impedance	Conjugated match to CSR BC5FM, BC6ROM

\* This catalog contains the typical specification only due to the limitation of space. When you consider the purchase of our products, please check our specification. For details of each product (characteristics graph, reliability information, precautions for use, and so on), see our Web site (<http://www.ty-top.com/>) or CD catalogs.

# PACKAGING

## ① Minimum Quantity

Type	Embossed Tape [pcs]
212B	3000
212L	
212C	
212P	
168B	4000
168L	
168T	
168D	
105B	10000
105L	

## ② Tape Material

Embossed Tape  
Card Board Carrier Tape

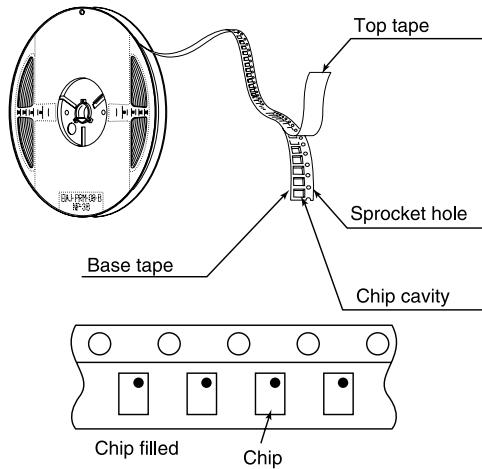

## ● Taped package

Type (EIA)	Thickness mm (inch)	Standard Quantity [pcs] Embossed tape
212B	0.90 typ.(0.035)	3000
212L	0.45 typ.(0.018)	
212C	0.90 typ.(0.035)	
212P	0.90 typ.(0.035)	
168B	0.45 typ.(0.018)	4000
168L	0.45 typ.(0.018)	
168T	0.45 typ.(0.018)	
168D	0.45 typ.(0.018)	
105B	0.30 typ.(0.0118)	10000
105L	0.30 typ.(0.0118)	

## ③ Taping Dimensions

- Embossed tape 0.315 inches wide (212B Type, 212C Type)
- Paper tape 0.315 inches wide (212L Type, 168B Type, 168L Type, 168T Type, 168D Type, 105B Type, 105L Type)

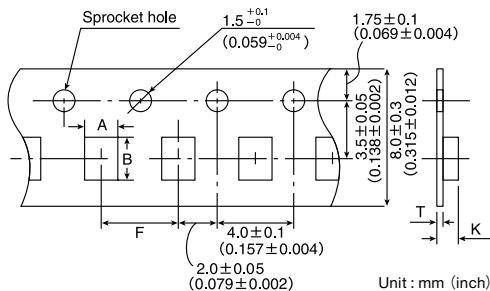

Type (EIA)	Chip cavity		Insertion Pitch F	Tape Thickness max.	
	A	B		K	T
212B	$1.5 \pm 0.25$ ( $0.059 \pm 0.008$ )	$2.3 \pm 0.2$ ( $0.091 \pm 0.008$ )	$4.0 \pm 0.1$ ( $0.157 \pm 0.004$ )	1.6 (0.063)	0.3 (0.012)
212L	$1.55 \pm 0.2$ ( $0.061 \pm 0.008$ )	$2.3 \pm 0.2$ ( $0.091 \pm 0.008$ )		0.65 (0.026)	0.65 (0.026)
212C	$1.55 \pm 0.2$ ( $0.061 \pm 0.008$ )	$2.3 \pm 0.2$ ( $0.091 \pm 0.008$ )	$4.0 \pm 0.1$ ( $0.157 \pm 0.004$ )	1.6 (0.063)	0.3 (0.012)
212P	$1.55 \pm 0.2$ ( $0.061 \pm 0.008$ )	$2.3 \pm 0.2$ ( $0.091 \pm 0.008$ )	$4.0 \pm 0.1$ ( $0.157 \pm 0.004$ )	1.6 (0.063)	0.3 (0.012)
168B	$1.00 \pm 0.05$ ( $0.039 \pm 0.002$ )	$1.80 \pm 0.05$ ( $0.071 \pm 0.002$ )	$4.0 \pm 0.1$ ( $0.157 \pm 0.004$ )	0.55 (0.022)	0.55 (0.022)
168L	$1.00 \pm 0.05$ ( $0.039 \pm 0.002$ )	$1.80 \pm 0.05$ ( $0.071 \pm 0.002$ )	$4.0 \pm 0.1$ ( $0.157 \pm 0.004$ )	0.55 (0.022)	0.55 (0.022)
168T	$1.00 \pm 0.05$ ( $0.039 \pm 0.002$ )	$1.80 \pm 0.05$ ( $0.071 \pm 0.002$ )	$4.0 \pm 0.1$ ( $0.157 \pm 0.004$ )	0.55 (0.022)	0.55 (0.022)
168D	$1.00 \pm 0.05$ ( $0.039 \pm 0.002$ )	$1.80 \pm 0.05$ ( $0.071 \pm 0.002$ )	$4.0 \pm 0.1$ ( $0.157 \pm 0.004$ )	0.55 (0.022)	0.55 (0.022)
105B	$0.62 \pm 0.03$ ( $0.024 \pm 0.001$ )	$1.12 \pm 0.03$ ( $0.044 \pm 0.001$ )	$2.0 \pm 0.05$ ( $0.079 \pm 0.002$ )	0.45 (0.018)	0.45 (0.018)
105L	$0.62 \pm 0.03$ ( $0.024 \pm 0.001$ )	$1.12 \pm 0.03$ ( $0.044 \pm 0.001$ )	$2.0 \pm 0.05$ ( $0.079 \pm 0.002$ )	0.45 (0.018)	0.45 (0.018)

Unit: mm (inch)

## ④ Leader and Blank Portion

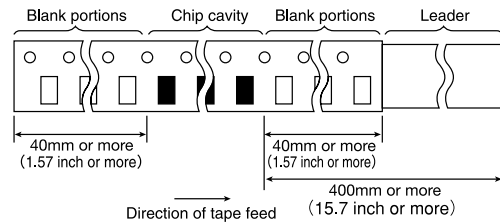

## ⑤ Reel size

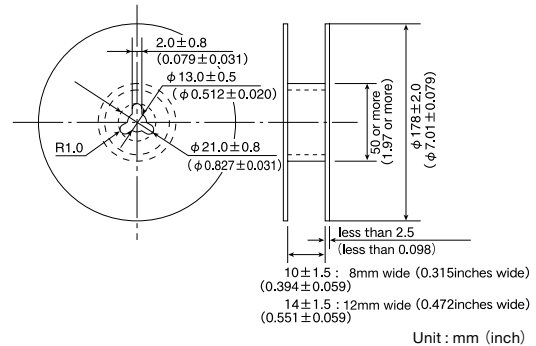

## ⑥ Top Tape Strength

The top tape requires a peel-off force of 0.1~0.7N in the direction of the arrow as illustrated below.

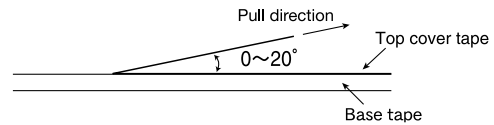

\* This catalog contains the typical specification only due to the limitation of space. When you consider the purchase of our products, please check our specification. For details of each product (characteristics graph, reliability information, precautions for use, and so on), see our Web site (<http://www.ty-top.com/>) or CD catalogs.



## RELIABILITY DATA

### 1. Operating Temperature Range

Specified Value : -30~+85°C

### 2. Storage Temperature Range

Specified Value : -30~+85°C

#### [Test Methods and Remarks]

※Note : -20 to +35°C in taped packaging

### 3. Resistance to Flexure of Substrate

Specified Value : No mechanical damage.

#### [Test Methods and Remarks]

Warp : 2mm  
Testing board : Glass epoxy-resin substrate  
Thickness : 0.8mm

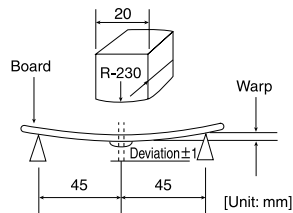

[Unit: mm]

### 4. Adhesion of Electrode

Specified Value : Characteristics: shall satisfy the electrical characteristics.  
Appearance : No significant abnormality.

#### [Test Methods and Remarks]

Applied force : 5N  
Duration : 10 sec.

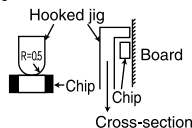

### 5. Solderability

Specified Value : 75% or more of immersed surface of terminal electrode shall be covered with fresh solder.

#### [Test Methods and Remarks]

Solder temperature : 230±5°C      Preconditioning : Immersion into flux.  
Duration : 4±1 sec.      Immersion and Removal speed : 25mm/sec.

### 6. Resistance to Solder Heat

Specified Value : Characteristics: shall satisfy the electrical characteristics.  
Appearance : No significant abnormality.

#### [Test Methods and Remarks]

Preheating : 150°C for 2 min.      Preconditioning : Immersion into flux.  
Solder temperature : 260±5°C      Immersion and Removal speed : 25mm/sec.  
Duration : 5±0.5 sec.      Recovery : 2 to 3 hrs of recovery under the standard condition after the removal from test chamber.

### 7. Thermal Shock

Specified Value : Characteristics: shall satisfy the electrical characteristics.  
Appearance : No significant abnormality.

#### [Test Methods and Remarks]

According to JIS C 0025.

Conditions for 1 cycle

Step	Temperature (°C)	Duration (min)
1	-40±3°C	30±3
2	Room Temperature	Within 3
3	85±2°C	30±3
4	Room Temperature	Within 3

Number of cycles : 100  
Mounting method : Soldering onto PC board.  
Recovery : 2 to 3 hrs of recovery under the standard condition after the removal from test chamber.

### 8. Humidity (steady state)

Specified Value : Characteristics: shall satisfy the electrical characteristics.  
Appearance : No significant abnormality.

#### [Test Methods and Remarks]

Temperature : +40±2°C      Duration : 96 hrs  
Humidity : 90~95%RH      Recovery : 2 to 3 hrs of recovery under the standard condition after the removal from test chamber.

### 9. High temperature life test

Specified Value : Characteristics: shall satisfy the electrical characteristics.  
Appearance : No significant abnormality.

#### [Test Methods and Remarks]

Temperature : +85±2°C      Recovery : 2 to 3 hrs of recovery under the standard condition after the removal from test chamber.  
Duration : 96 hrs

### 10. Low temperature life test

Specified Value : Characteristics: shall satisfy the electrical characteristics.  
Appearance : No significant abnormality.

#### [Test Methods and Remarks]

Temperature : -40±2°C      Recovery : 2 to 3 hrs of recovery under the standard condition after the removal from test chamber.  
Duration : 96 hrs

Note on standard condition:

"standard condition" referred to herein is defined as follows :  
5 to 35°C of temperature, 45 to 85% relative humidity and 86 to 106kPa of air pressure.

When there are questions concerning measurement result :  
In order to provide correlation data, the test shall be conducted under condition of 20±2°C of temperature, 60 to 70% relative humidity and 86 to 106kPa of air pressure.  
Unless otherwise specified, all the tests are conducted under the "standard condition".

\* This catalog contains the typical specification only due to the limitation of space. When you consider the purchase of our products, please check our specification.  
For details of each product (characteristics graph, reliability information, precautions for use, and so on), see our Web site (<http://www.ty-top.com/>) or CD catalogs.

# PRECAUTIONS

## 1. PCB Design

### ◆ Land pattern design Land pattern dimension examples

Technical considerations

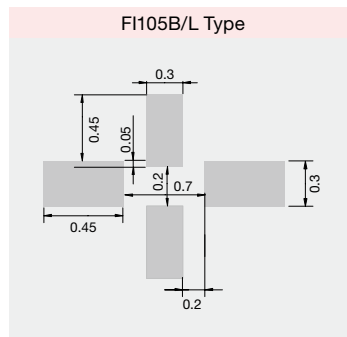
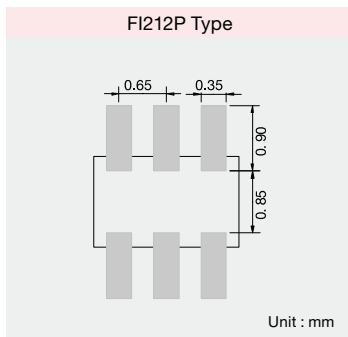
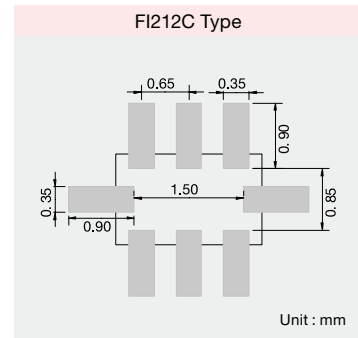
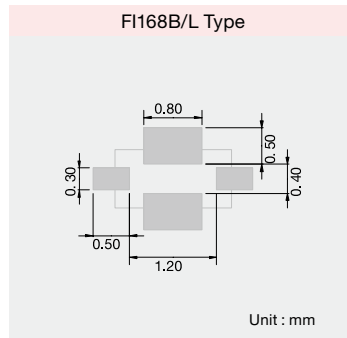
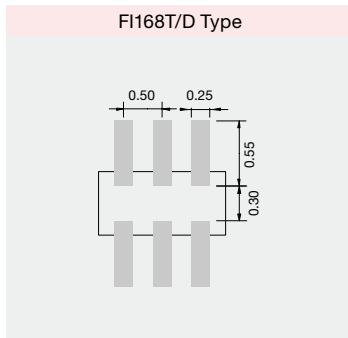
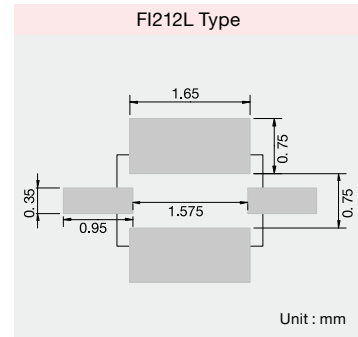
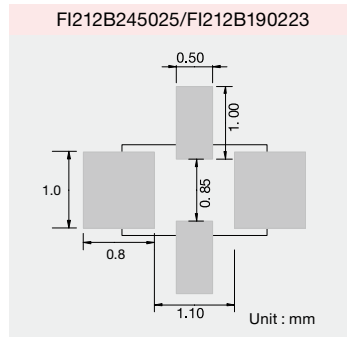
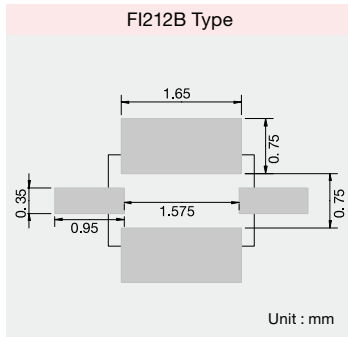

## 2. Soldering

### ◆ Conditions for Reflow soldering (for reference)

#### [Reflow Profile]

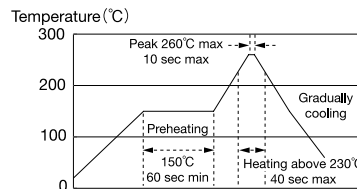
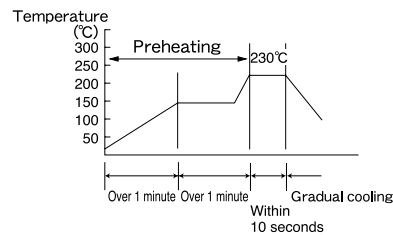

※ Components should be preheated to within 100 to 130°C from soldering temperature.  
 ※ Assured to be reflow soldering for 2 times.

Note: The above profiles are the maximum allowable soldering condition, therefore these profiles are not always recommended.

Technical considerations

## 3. Storage conditions

### ◆ Storage

1. To maintain the solderability of terminal electrodes and to keep the packaging material in good condition, care must be taken to control temperature and humidity in the storage area. Humidity should especially be kept as low as possible.

• Recommended conditions

Ambient temperature : -20~+35°C

Humidity : Below 60%RH

The ambient temperature must be kept below 30°C.

Even under ideal storage conditions, the solderability of electrodes decreases gradually, so filters should be mounted within 6 months from the time of delivery.

• The packaging material should be kept where no chlorine or sulfur exists in the air.

Precautions

### ◆ Storage

1. If the parts are stocked in a high temperature and humidity environment, problems such as reduced solderability caused by oxidation of terminal electrodes and deterioration of taping/ packaging materials may take place. For this reason, components should be used within 6 months from the time of delivery. If exceeding the above period, please check the solderability before using the filter.

Technical considerations

■ Please contact of our offices for further details of specifications.  
 All of the standard values listed here are subject to change without notice.  
 Therefore, please check the specifications carefully before use.

\* This catalog contains the typical specification only due to the limitation of space. When you consider the purchase of our products, please check our specification.  
 For details of each product (characteristics graph, reliability information, precautions for use, and so on), see our Web site (<http://www.ty-top.com/>) or CD catalogs.