



HD1520FX

HIGH VOLTAGE NPN POWER TRANSISTOR FOR HIGH DEFINITION CRT DISPLAYS

- STATE-OF-THE-ART TECHNOLOGY: DIFFUSED COLLECTOR "ENHANCED GENERATION" EHVS1
- WIDER RANGE OF OPTIMUM DRIVE CONDITIONS
- LESS SENSITIVE TO OPERATING TEMPERATURE VARIATION
- FULLY INSULATED POWER PACKAGE U.L. COMPLIANT

APPLICATIONS

- HORIZONTAL DEFLECTION FOR LARGE AND FLAT SCREEN 100 Hz COLOR TVs

DESCRIPTION

The device is manufactured using Diffused Collector in Planar technology adopting "Enhance High Voltage Structure" (EHVS1) developed to fit High-Definition CRT displays.

The new HD product series show improved silicon efficiency bringing updated performance to the Horizontal Deflection stage.

Figure 1: Package

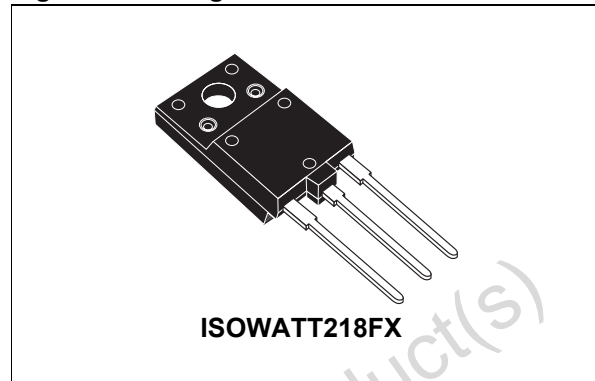

Figure 2: Internal Schematic Diagram

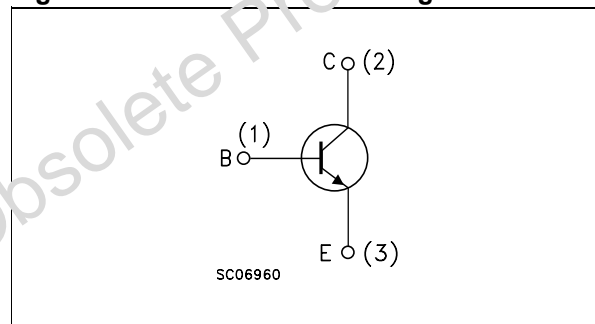

Table 1:

Part Number	Marking	Package	Packaging
HD1520FX	HD1520FX	ISOWATT218FX	TUBE

Table 2: Absolute Maximum Ratings

Symbol	Parameter	Value	Unit
V_{CES}	Collector-Emitter Voltage ($V_{BE} = 0$)	1500	V
V_{CEO}	Collector-Emitter Voltage ($I_B = 0$)	700	V
V_{EBO}	Emitter-Base Voltage ($I_C = 0$)	10	V
I_C	Collector Current	15	A
I_{CM}	Collector Peak Current ($t_p < 5ms$)	22	A
I_B	Base Current	8	A
I_{BM}	Base Peak Current ($t_p < 5ms$)	12	A
P_{tot}	Total Dissipation at $T_C = 25^\circ C$	64	W
V_{ins}	Insulation Withstand Voltage (RMS) from All Three Leads to External Heatsink	2500	V

HD1520FX

Symbol	Parameter	Value	Unit
T_{stg}	Storage Temperature	-65 to 150	°C
T_J	Max. Operating Junction Temperature	150	°C

Table 3: Thermal Data

$R_{thj-case}$	Thermal Resistance Junction-Case	Max	1.95	°C/W
----------------	----------------------------------	-----	------	------

Table 4: Electrical Characteristics ($T_{case} = 25\text{ °C}$ unless otherwise specified)

Symbol	Parameter	Test Conditions	Min.	Typ.	Max.	Unit
I_{CES}	Collector Cut-off Current ($V_{BE} = 0$)	$V_{CE} = 1500\text{ V}$			0.2	mA
		$V_{CE} = 1500\text{ V}$ $T_C = 125\text{ °C}$			2	mA
I_{EBO}	Emitter Cut-off Current ($I_C = 0$)	$V_{EB} = 5\text{ V}$			10	μA
$V_{CEO(sus)}^*$	Collector-Emitter Sustaining Voltage ($I_B = 0$)	$I_C = 100\text{ mA}$	700			V
V_{EBO}	Emitter-Base Voltage ($I_C = 0$)	$I_E = 10\text{ mA}$	10			V
$V_{CE(sat)}^*$	Collector-Emitter Saturation Voltage	$I_C = 9\text{ A}$ $I_B = 1.8\text{ A}$			3	V
$V_{BE(sat)}^*$	Base-Emitter Saturation Voltage	$I_C = 9\text{ A}$ $I_B = 1.8\text{ A}$			1.3	V
h_{FE}	DC Current Gain	$I_C = 1\text{ A}$ $V_{CE} = 5\text{ V}$		26		
		$I_C = 9\text{ A}$ $V_{CE} = 1\text{ V}$		5		
		$I_C = 9\text{ A}$ $V_{CE} = 5\text{ V}$	5.5		9.5	
t_s t_f	INDUCTIVE LOAD Storage Time Fall Time	$I_C = 9\text{ A}$ $f_h = 31250\text{ Hz}$				
		$I_{B(on)} = 1.3\text{ A}$ $I_{B(off)} = -4.2\text{ A}$ $L_{BB(on)} = 1.9\text{ μH}$ $V_{BE(off)} = -2.7\text{ V}$ $V_{CE(fly)} = 1040\text{ V}$		3.2	4	μs ns

* Pulsed: Pulsed duration = 300 μs, duty cycle ≤ 1.5 %.

Figure 3: Safe Operating Area

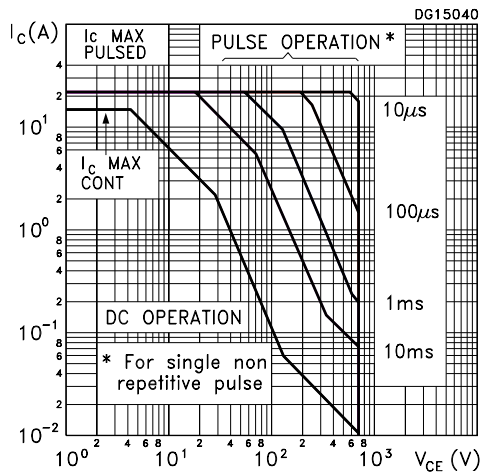

Figure 4: Output Characteristics

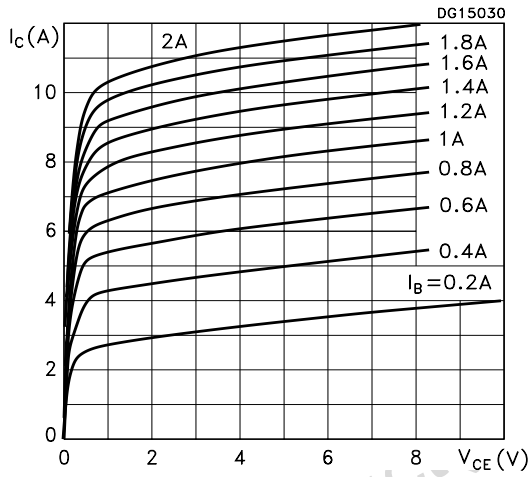

Figure 5: DC Current Gain

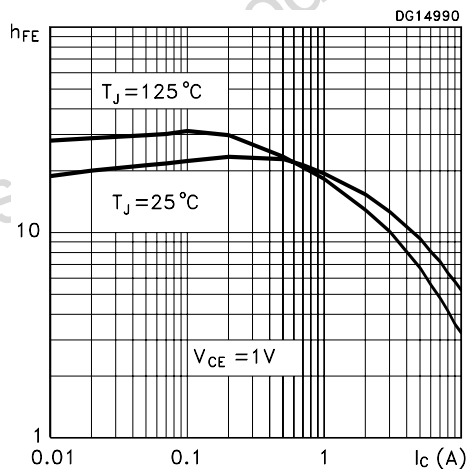

Figure 6: Derating Curve

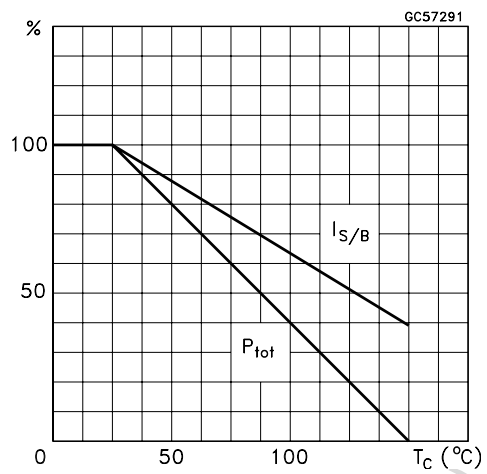

Figure 7: Reverse Biased SOA

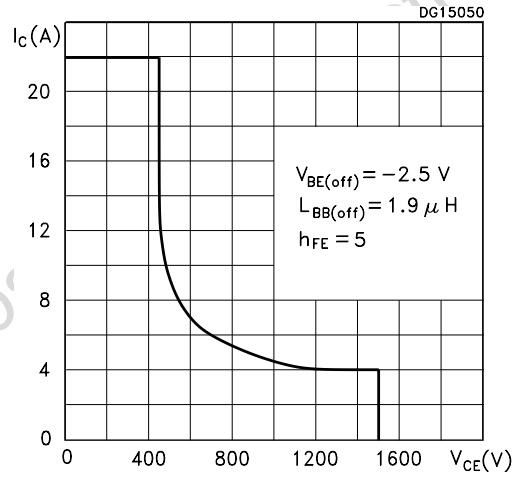

Figure 8: DC Current Gain

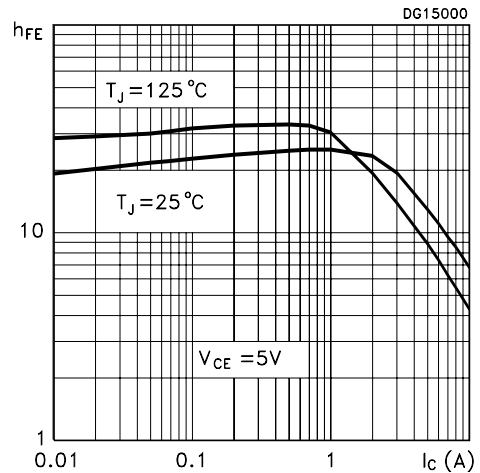

Figure 9: Collector-Emitter Saturation Voltage

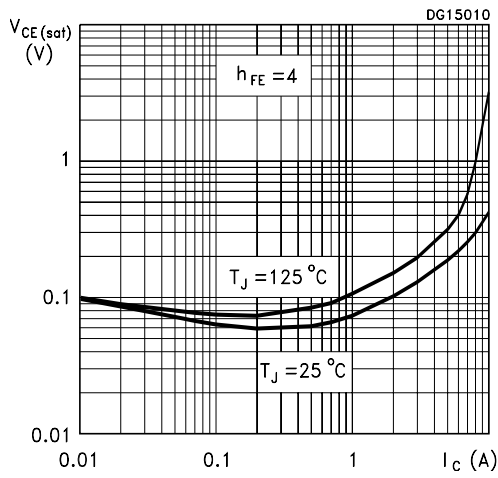

Figure 10: Power Losses

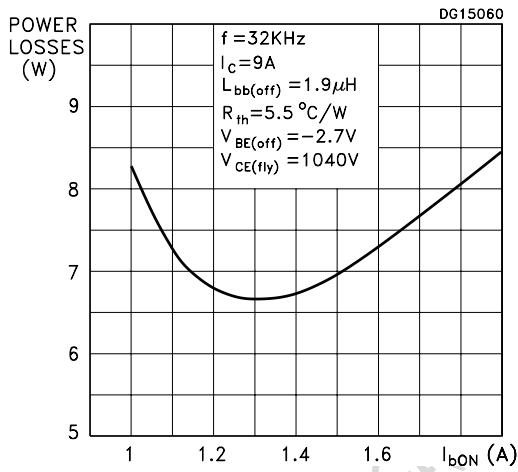

Figure 11: Base-Emitter Saturation Voltage

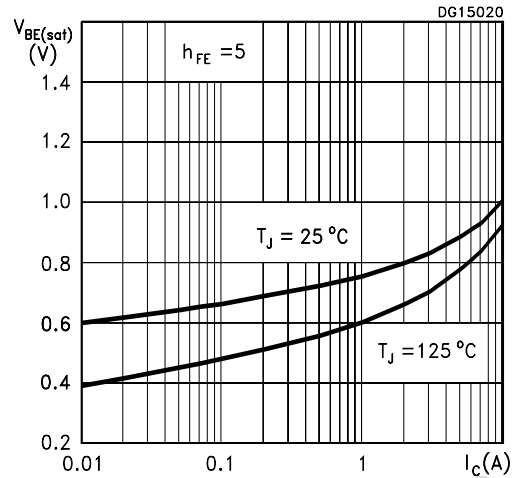

Figure 12: Inductive Load Switching Time

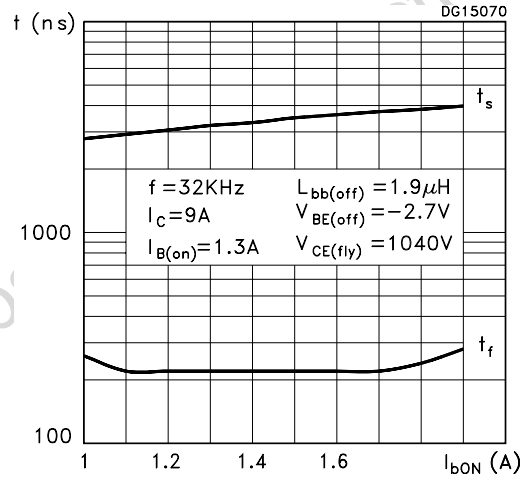

Figure 13: Power Losses and Inductive Load Switching Test Circuit

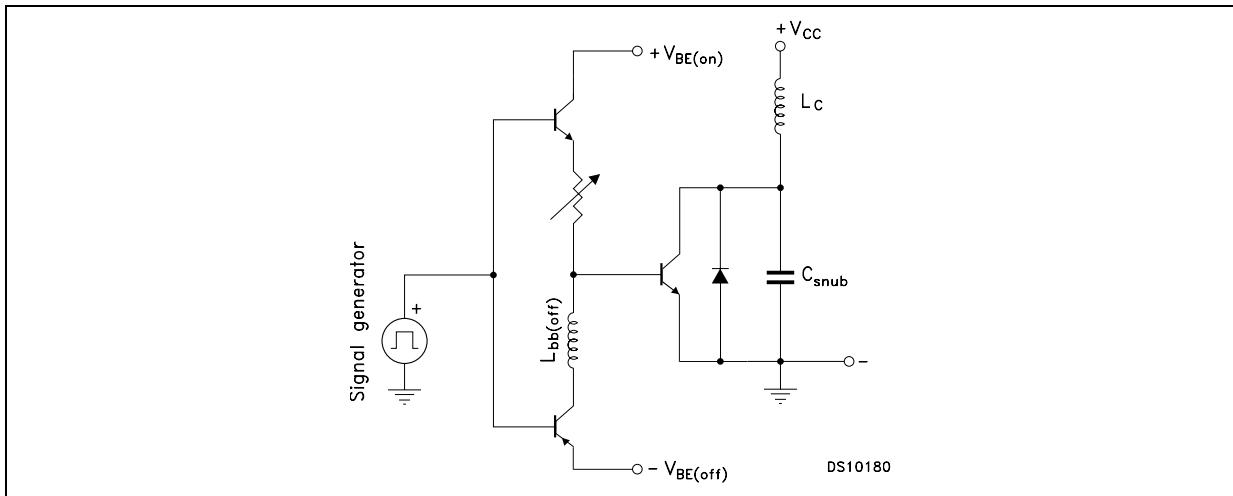
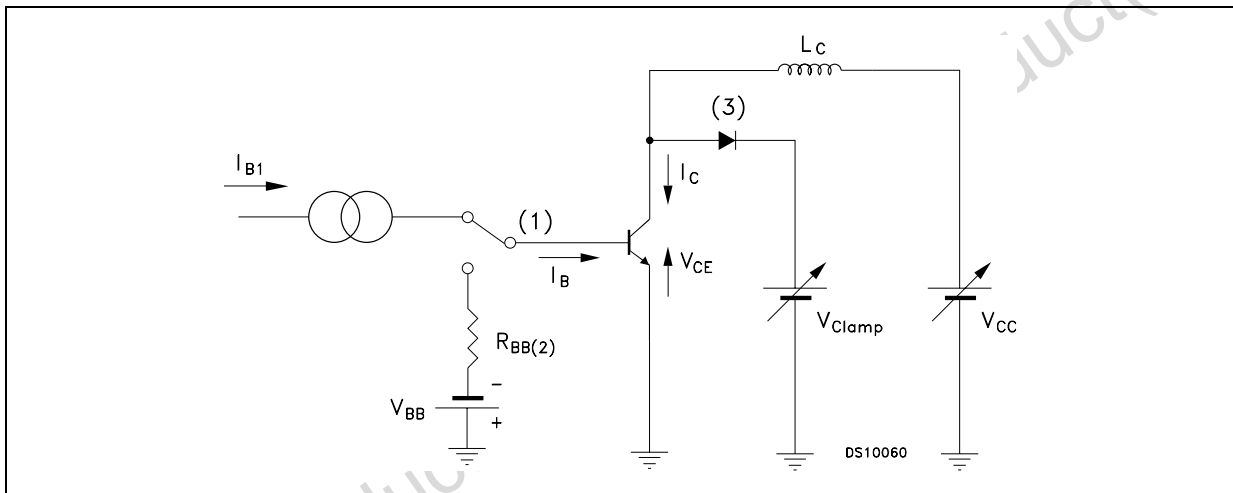

Figure 14: Reverse Biased Safe Operating Area Test Circuit



Obsolete Product

ISOWATT218FX MECHANICAL DATA

DIM.	mm			inch		
	MIN.	TYP.	MAX.	MIN.	TYP.	MAX.
A	5.30		5.70	0.209		0.224
C	2.80		3.20	0.110		0.126
D	3.10		3.50	0.122		0.138
D1	1.80		2.20	0.071		0.087
E	0.80		1.10	0.031		0.043
F	0.65		0.95	0.026		0.037
F2	1.80		2.20	0.071		0.087
G	10.30		11.50	0.406		0.453
G1		5.45			0.215	
H	15.30		15.70	0.602		0.618
L	9.0		10.20	0.354		0.402
L2	22.80		23.20	0.898		0.913
L3	26.30		26.70	1.035		1.051
L4	43.20		44.40	1.701		1.748
L5	4.30		4.70	0.169		0.185
L6	24.30		24.70	0.957		0.972
L7	14.60		15.00	0.575		0.591
N	1.80		2.20	0.071		0.087
R	3.80		4.20	0.150		0.165
DIA	3.40		3.80	0.134		0.150

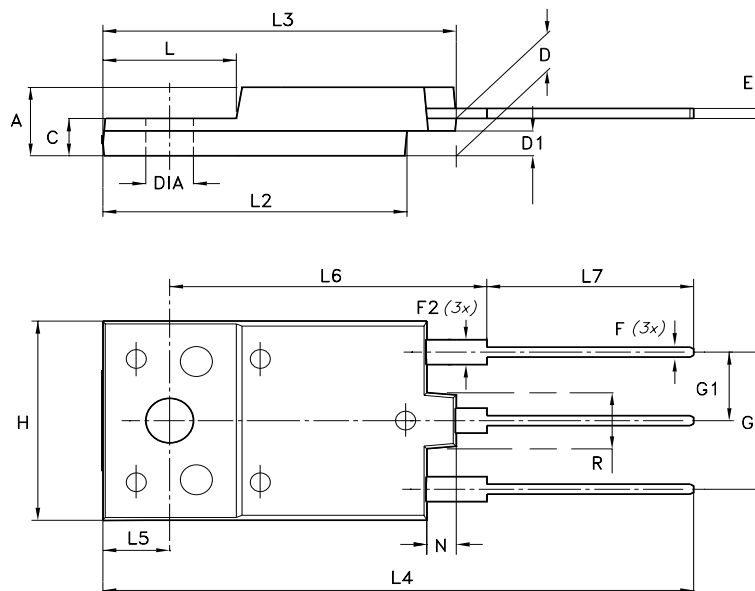

- Weight : 5.6 g (typ.)
- Maximum Torque (applied to mounting flange) Recommended: 0.55 Nm; Maximum: 1 Nm
- The side of the dissipator must be flat within 80 μm

Figure 5: Revision History

Version	Release Date	Change Designator
27-May-2005	0.1	Initial Release.

Obsolete Product(s) - Obsolete Product(s)

Information furnished is believed to be accurate and reliable. However, STMicroelectronics assumes no responsibility for the consequences of use of such information nor for any infringement of patents or other rights of third parties which may result from its use. No license is granted by implication or otherwise under any patent or patent rights of STMicroelectronics. Specifications mentioned in this publication are subject to change without notice. This publication supersedes and replaces all information previously supplied. STMicroelectronics products are not authorized for use as critical components in life support devices or systems without express written approval of STMicroelectronics.

The ST logo is a registered trademark of STMicroelectronics

All other names are the property of their respective owners

© 2005 STMicroelectronics - All Rights Reserved

STMicroelectronics group of companies

Australia - Belgium - Brazil - Canada - China - Czech Republic - Finland - France - Germany - Hong Kong - India - Israel - Italy - Japan -
Malaysia - Malta - Morocco - Singapore - Spain - Sweden - Switzerland - United Kingdom - United States of America

www.st.com