

IRFP344PbF

- Dynamic dv/dt Rating
- Repetitive Avalanche Rated
- Isolated Central Mounting Hole
- Fast Switching
- Ease of Paralleling
- Simple Drive Requirements
- Lead-Free

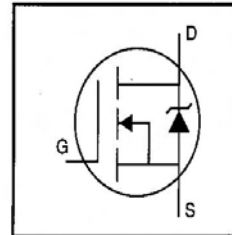

| |
|---------------------------|
| $V_{DSS} = 450V$ |
| $R_{DS(on)} = 0.63\Omega$ |
| $I_D = 9.5A$ |

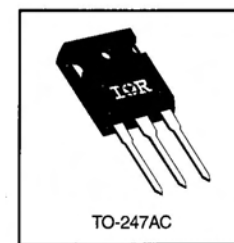

Description

Third Generation HEXFETs from International Rectifier provide the designer with the best combination of fast switching, ruggedized device design, low on-resistance and cost-effectiveness.

The TO-247 package is preferred for commercial–industrial applications where higher power levels preclude the use of TO-220 devices. The TO-247 is similar but superior to the earlier TO-218 package because of its isolated mounting hole. It also provides greater creepage distance between pins to meet the requirements of most safety specifications.

Absolute Maximum Ratings

| | Parameter | Max. | Units |
|---------------------------|--|-----------------------|-------|
| $I_D @ T_C = 25^\circ C$ | Continuous Drain Current, $V_{GS} @ 10 V$ | 9.5 | A |
| $I_D @ T_C = 100^\circ C$ | Continuous Drain Current, $V_{GS} @ 10 V$ | 6.0 | |
| I_{DM} | Pulsed Drain Current ① | 38 | |
| $P_D @ T_C = 25^\circ C$ | Power Dissipation | 150 | W |
| | Linear Derating Factor | 1.2 | W/°C |
| V_{GS} | Gate-to-Source Voltage | ±20 | V |
| E_{AS} | Single Pulse Avalanche Energy ② | 410 | mJ |
| I_{AR} | Avalanche Current ① | 9.5 | A |
| E_{AR} | Repetitive Avalanche Energy ① | 15 | mJ |
| dv/dt | Peak Diode Recovery dv/dt ③ | 3.5 | V/ns |
| T_J T_{STG} | Operating Junction and Storage Temperature Range | -55 to +150 | °C |
| | Soldering Temperature, for 10 seconds | 300 (1.6mm from case) | |
| | Mounting Torque, 6-32 or M3 screw | 10 lbf•in (1.1 N•m) | |

Thermal Resistance

| | Parameter | Min. | Typ. | Max. | Units |
|-----------------|-------------------------------------|------|------|------|-------|
| $R_{\theta JC}$ | Junction-to-Case | — | — | 0.83 | °C/W |
| $R_{\theta CS}$ | Case-to-Sink, Flat, Greased Surface | — | 0.24 | — | |
| $R_{\theta JA}$ | Junction-to-Ambient | — | — | 40 | |

IRFP344PbF

International
IR Rectifier

Electrical Characteristics @ $T_J = 25^\circ\text{C}$ (unless otherwise specified)

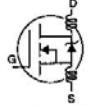
| | Parameter | Min. | Typ. | Max. | Units | Test Conditions |
|---------------------------------|--------------------------------------|------|------|------|---------------------|--|
| $V_{(BR)DSS}$ | Drain-to-Source Breakdown Voltage | 450 | — | — | V | $V_{GS}=0V, I_D=250\mu A$ |
| $\Delta V_{(BR)DSS}/\Delta T_J$ | Breakdown Voltage Temp. Coefficient | — | 0.59 | — | V/ $^\circ\text{C}$ | Reference to $25^\circ\text{C}, I_D=1\text{mA}$ |
| $R_{DS(on)}$ | Static Drain-to-Source On-Resistance | — | — | 0.63 | Ω | $V_{GS}=10V, I_D=5.7A$ ④ |
| $V_{GS(th)}$ | Gate Threshold Voltage | 2.0 | — | 4.0 | V | $V_{DS}=V_{GS}, I_D=250\mu A$ |
| g_{fs} | Forward Transconductance | 5.0 | — | — | S | $V_{DS}=50V, I_D=5.7A$ ④ |
| I_{DSS} | Drain-to-Source Leakage Current | — | — | 25 | μA | $V_{DS}=450V, V_{GS}=0V$ |
| | | — | — | 250 | | $V_{DS}=360V, V_{GS}=0V, T_J=125^\circ\text{C}$ |
| I_{GSS} | Gate-to-Source Forward Leakage | — | — | 100 | nA | $V_{GS}=20V$ |
| | Gate-to-Source Reverse Leakage | — | — | -100 | | $V_{GS}=-20V$ |
| Q_g | Total Gate Charge | — | — | 80 | nC | $I_D=8.8A$ |
| Q_{gs} | Gate-to-Source Charge | — | — | 12 | | $V_{DS}=360V$ |
| Q_{gd} | Gate-to-Drain ("Miller") Charge | — | — | 41 | | $V_{GS}=10V$ See Fig. 6 and 13 ④ |
| $t_{d(on)}$ | Turn-On Delay Time | — | 8.7 | — | ns | $V_{DD}=225V$ |
| t_r | Rise Time | — | 28 | — | | $I_D=8.8A$ |
| $t_{d(off)}$ | Turn-Off Delay Time | — | 58 | — | | $R_G=9.1\Omega$ |
| t_f | Fall Time | — | 27 | — | | $R_D=25\Omega$ See Figure 10 ④ |
| L_D | Internal Drain Inductance | — | 5.0 | — | nH | Between lead, 6 mm (0.25in.) from package and center of die contact |
| L_S | Internal Source Inductance | — | 13 | — | |  |
| C_{iss} | Input Capacitance | — | 1400 | — | pF | $V_{GS}=0V$ |
| C_{oss} | Output Capacitance | — | 370 | — | | $V_{DS}=25V$ |
| C_{rss} | Reverse Transfer Capacitance | — | 140 | — | | $f=1.0\text{MHz}$ See Figure 5 |

Source-Drain Ratings and Characteristics

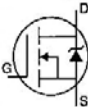
| | Parameter | Min. | Typ. | Max. | Units | Test Conditions |
|----------|--|---|------|------|---------|--|
| I_S | Continuous Source Current (Body Diode) | — | — | 9.5 | A | MOSFET symbol showing the integral reverse p-n junction diode.  |
| I_{SM} | Pulsed Source Current (Body Diode) ① | — | — | 38 | | |
| V_{SD} | Diode Forward Voltage | — | — | 2.0 | V | $T_J=25^\circ\text{C}, I_S=9.5A, V_{GS}=0V$ ④ |
| t_{rr} | Reverse Recovery Time | — | 490 | 740 | ns | $T_J=25^\circ\text{C}, I_F=8.8A$ |
| Q_{rr} | Reverse Recovery Charge | — | 3.2 | 4.8 | μC | $di/dt=100A/\mu s$ ④ |
| t_{on} | Forward Turn-On Time | Intrinsic turn-on time is negligible (turn-on is dominated by L_S+L_D) | | | | |

Notes:

- ① Repetitive rating; pulse width limited by max. junction temperature (See Figure 11)
- ② $V_{DD}=50V$, starting $T_J=25^\circ\text{C}$, $L=8.1\text{mH}$, $R_G=25\Omega$, $I_{AS}=9.5A$ (See Figure 12)
- ③ $I_{SD}\leq 9.5A$, $di/dt\leq 90A/\mu s$, $V_{DD}\leq V_{(BR)DSS}$, $T_J\leq 150^\circ\text{C}$
- ④ Pulse width $\leq 300\mu s$; duty cycle $\leq 2\%$.

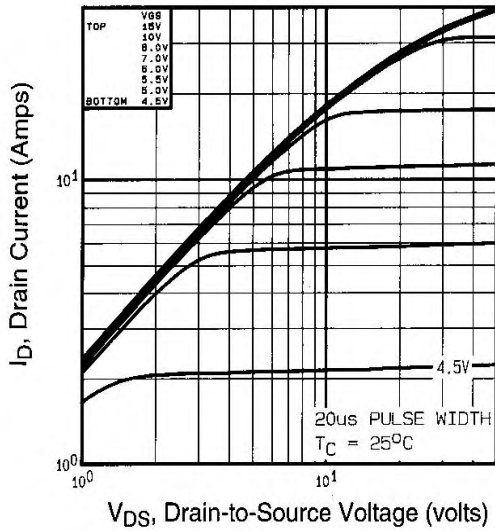

Fig 1. Typical Output Characteristics,
 $T_C=25^\circ\text{C}$

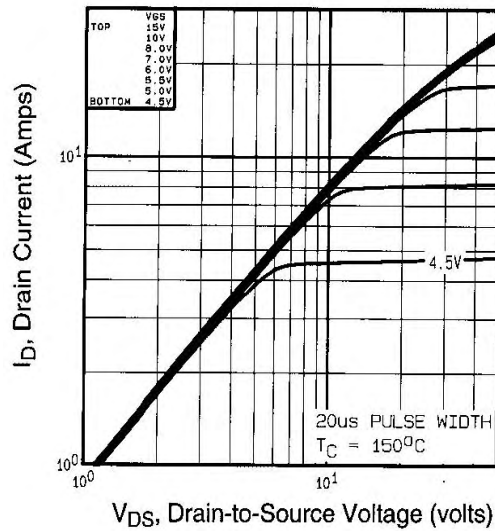

Fig 2. Typical Output Characteristics,
 $T_C=150^\circ\text{C}$

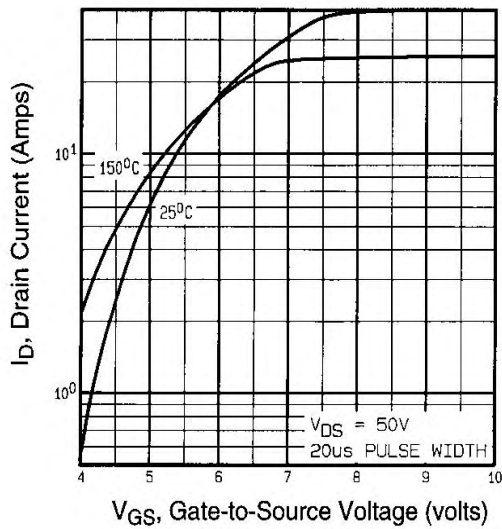

Fig 3. Typical Transfer Characteristics

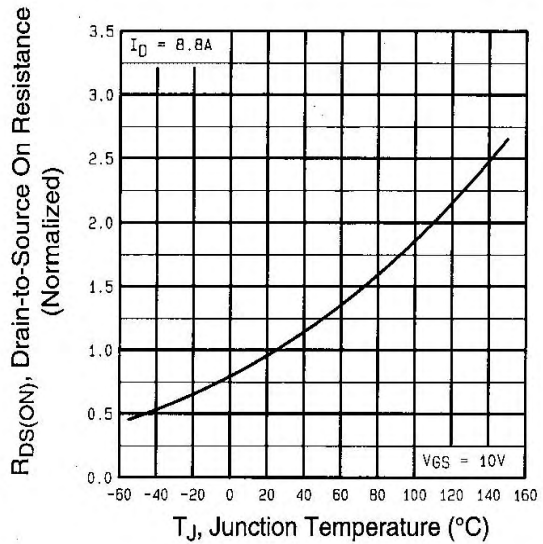

Fig 4. Normalized On-Resistance
 Vs. Temperature

IRFP344PbF

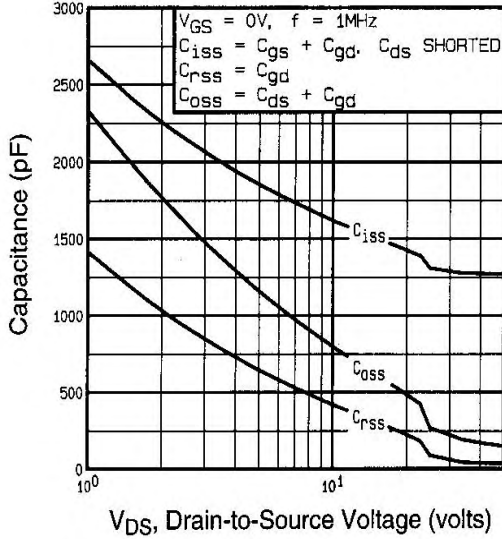

Fig 5. Typical Capacitance Vs. Drain-to-Source Voltage

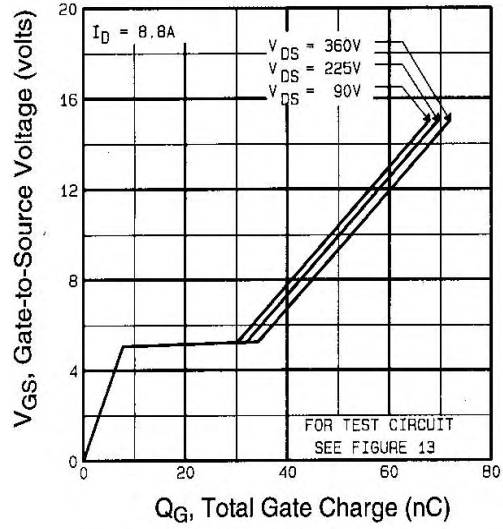

Fig 6. Typical Gate Charge Vs. Gate-to-Source Voltage

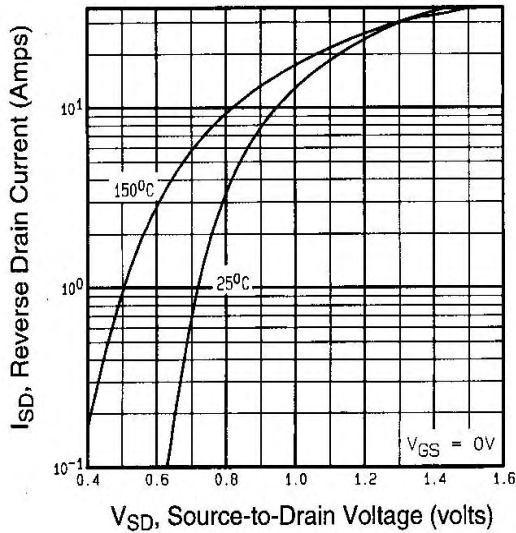

Fig 7. Typical Source-Drain Diode Forward Voltage

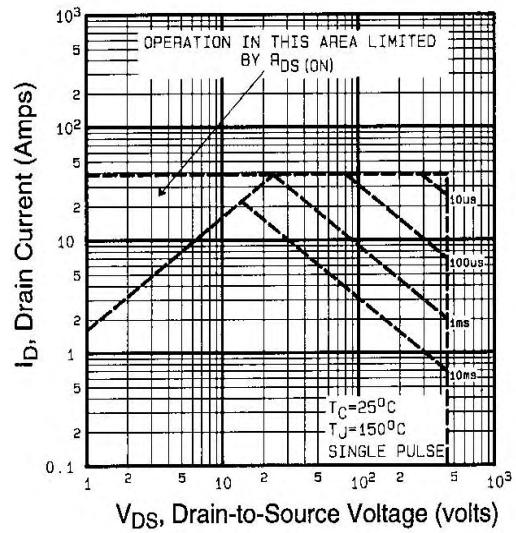

Fig 8. Maximum Safe Operating Area

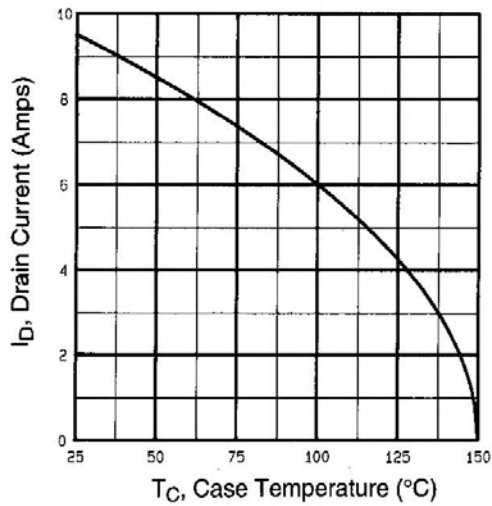

Fig 9. Maximum Drain Current Vs. Case Temperature

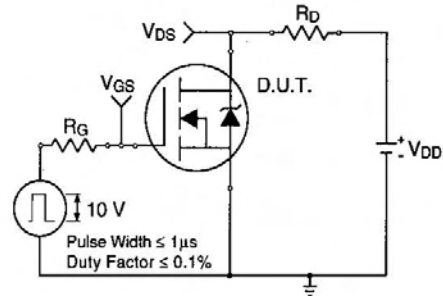

Fig 10a. Switching Time Test Circuit

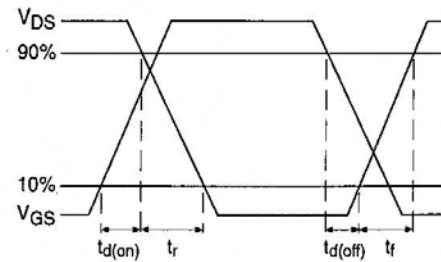

Fig 10b. Switching Time Waveforms

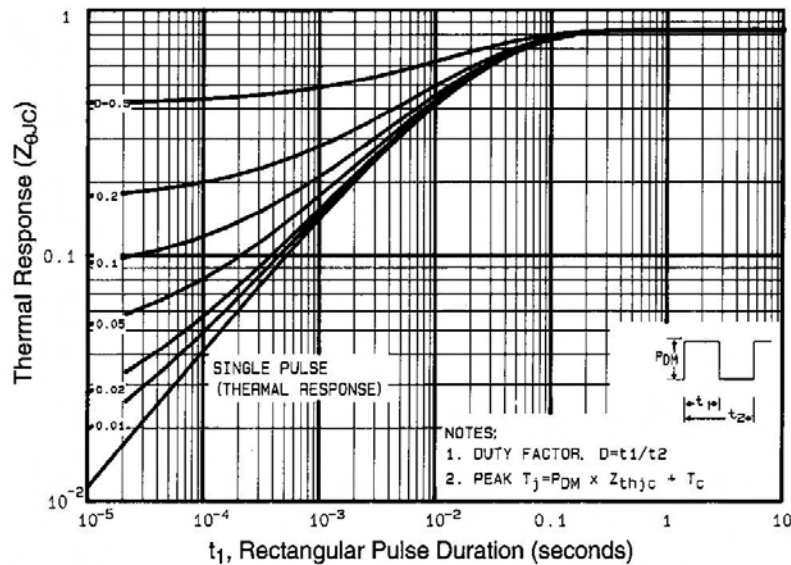

Fig 11. Maximum Effective Transient Thermal Impedance, Junction-to-Case

IRFP344PbF

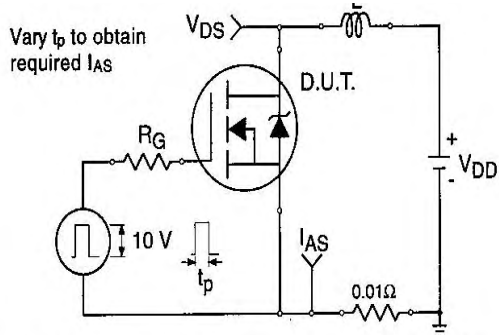

Fig 12a. Unclamped Inductive Test Circuit

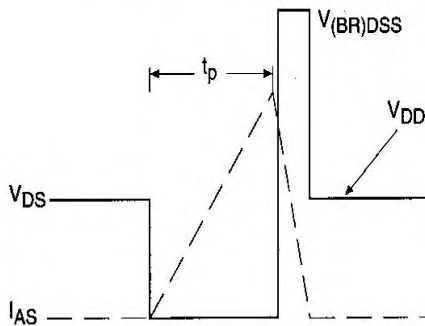

Fig 12b. Unclamped Inductive Waveforms

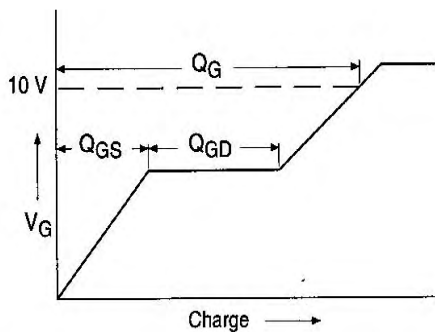

Fig 13a. Basic Gate Charge Waveform

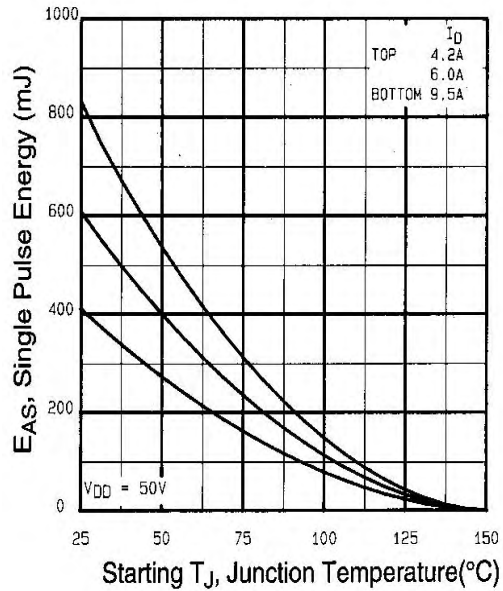

Fig 12c. Maximum Avalanche Energy Vs. Drain Current

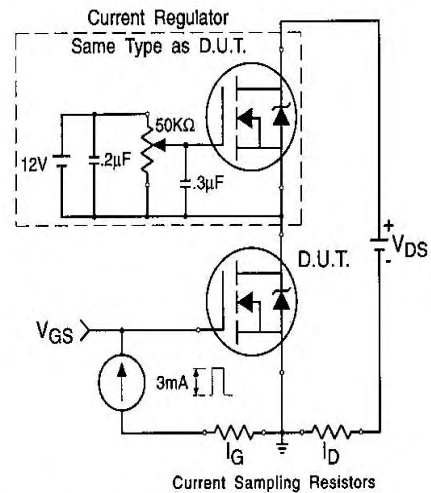
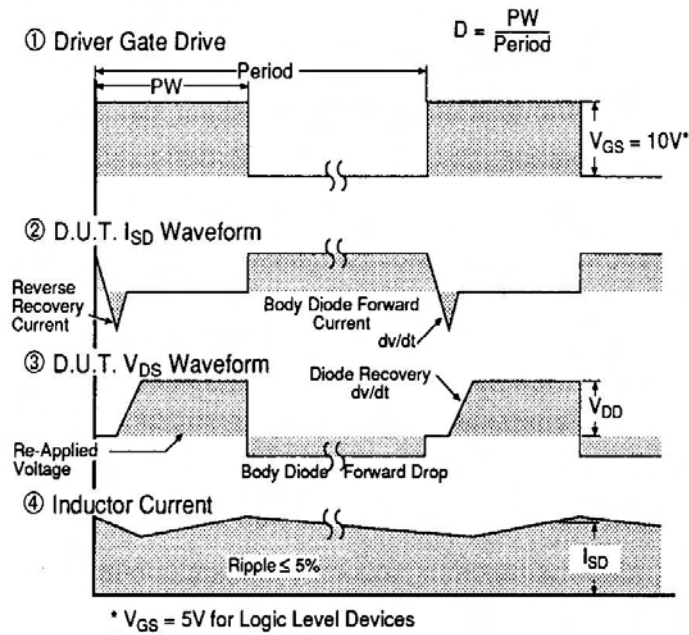
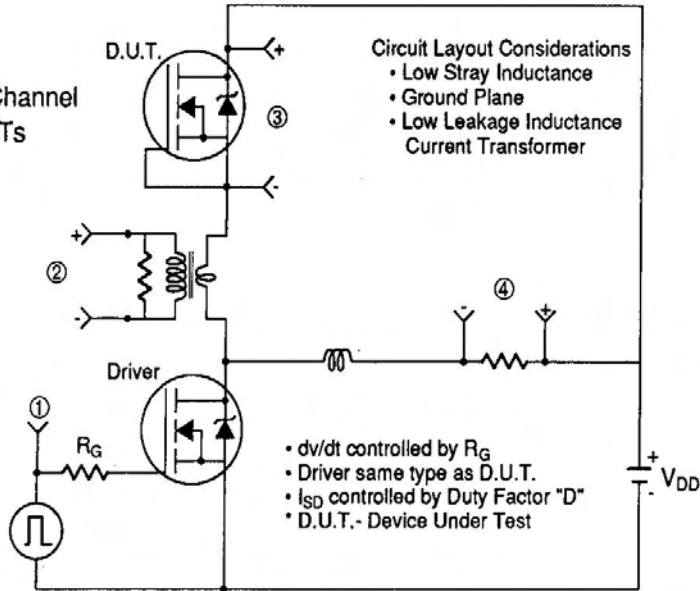

Fig 13b. Gate Charge Test Circuit

Peak Diode Recovery dv/dt Test Circuit

Fig 14. For N-Channel HEXFETs



IRFP344PbF

International
IR Rectifier

TO-247AC Package Outline Dimensions are shown in millimeters (inches)

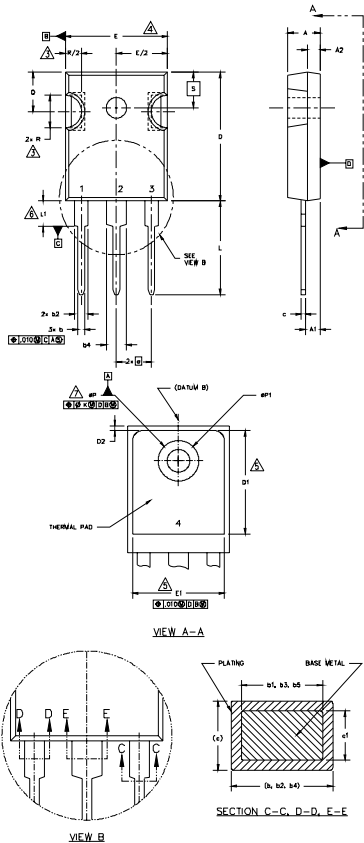

NOTES:

- DIMENSIONING AND TOLERANCING PER ASME Y14.5M 1994.
- DIMENSIONS ARE SHOWN IN INCHES [MILLIMETERS]
- CONTOUR OF SLOT OPTIONAL.
- DIMENSION D & E DO NOT INCLUDE MOLD FLASH. MOLD FLASH SHALL NOT EXCEED .005" (0.127) PER SIDE. THESE DIMENSIONS ARE MEASURED AT THE OUTERMOST EXTREMES OF THE PLASTIC BODY.
- THERMAL PAD CONTOUR OPTIONAL WITHIN DIMENSIONS D1 & E1.
- LEAD FINISH UNCONTROLLED IN L1.
- ØP TO HAVE A MAXIMUM DRAFT ANGLE OF 1.5 ° TO THE TOP OF THE PART WITH A MAXIMUM HOLE DIAMETER OF .154" [3.91].
- OUTLINE CONFORMS TO JEDEC OUTLINE TO-247 WITH THE EXCEPTION OF DIMENSION c.

| SYMBOL | DIMENSIONS | | | | NOTES |
|--------|------------|------|-------------|-------|-------|
| | INCHES | | MILLIMETERS | | |
| | MIN. | MAX. | MIN. | MAX. | |
| A | .183 | .209 | 4.65 | 5.31 | |
| A1 | .087 | .102 | 2.21 | 2.59 | |
| A2 | .059 | .098 | 1.50 | 2.49 | |
| b | .039 | .055 | 0.99 | 1.40 | |
| b1 | .039 | .053 | 0.99 | 1.35 | |
| b2 | .065 | .094 | 1.65 | 2.39 | |
| b3 | .065 | .092 | 1.65 | 2.37 | |
| b4 | .102 | .135 | 2.59 | 3.43 | |
| b5 | .102 | .133 | 2.59 | 3.38 | |
| c | .015 | .034 | 0.38 | 0.86 | |
| c1 | .015 | .030 | 0.38 | 0.76 | |
| D | .776 | .815 | 19.71 | 20.70 | 4 |
| D1 | .515 | - | 13.08 | - | 5 |
| D2 | .020 | .030 | 0.51 | 0.76 | |
| E | .602 | .625 | 15.29 | 15.87 | 4 |
| E1 | .540 | - | 13.72 | - | |
| e | .215 BSC | | 5.46 BSC | | |
| Øk | Ø10 | | 2.54 | | |
| L | .559 | .634 | 14.20 | 16.10 | |
| L1 | .146 | .169 | 3.71 | 4.29 | |
| N | 3 | | 7.62 BSC | | |
| ØP | .140 | .144 | 3.56 | 3.66 | |
| ØP1 | - | .275 | - | 6.98 | |
| Ø | .209 | .224 | 5.31 | 5.69 | |
| R | .178 | .216 | 4.52 | 5.49 | |
| S | .217 BSC | | 5.51 BSC | | |

LEAD ASSIGNMENTS

HEXFET

- GATE
- DRAIN
- SOURCE
- DRAIN

IGBTs, CoPACK

- GATE
- COLLECTOR
- EMITTER
- COLLECTOR

DIODES

- ANODE/OPEN
- CATHODE
- ANODE

TO-247AC Part Marking Information

EXAMPLE: THIS IS AN IRFPE30
WITH ASSEMBLY
LOT CODE 5657
ASSEMBLED ON WW35, 2000
IN THE ASSEMBLY LINE "H"

Note: "P" in assembly line position indicates "Lead-Free"

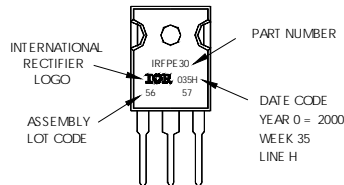

Data and specifications subject to change without notice.

International
IR Rectifier

IR WORLD HEADQUARTERS: 233 Kansas St., El Segundo, California 90245, USA Tel: (310) 252-7105
TAC Fax: (310) 252-7903
08/04



Notice

The products described herein were acquired by Vishay Intertechnology, Inc., as part of its acquisition of International Rectifier's Power Control Systems (PCS) business, which closed in April 2007. Specifications of the products displayed herein are pending review by Vishay and are subject to the terms and conditions shown below.

Specifications of the products displayed herein are subject to change without notice. Vishay Intertechnology, Inc., or anyone on its behalf, assumes no responsibility or liability for any errors or inaccuracies.

Information contained herein is intended to provide a product description only. No license, express or implied, by estoppel or otherwise, to any intellectual property rights is granted by this document. Except as provided in Vishay's terms and conditions of sale for such products, Vishay assumes no liability whatsoever, and disclaims any express or implied warranty, relating to sale and/or use of Vishay products including liability or warranties relating to fitness for a particular purpose, merchantability, or infringement of any patent, copyright, or other intellectual property right.

The products shown herein are not designed for use in medical, life-saving, or life-sustaining applications. Customers using or selling these products for use in such applications do so at their own risk and agree to fully indemnify Vishay for any damages resulting from such improper use or sale.

International Rectifier®, IR®, the IR logo, HEXFET®, HEXSense®, HEXDIP®, DOL®, INTERO®, and POWIRTRAIN® are registered trademarks of International Rectifier Corporation in the U.S. and other countries. All other product names noted herein may be trademarks of their respective owners.