

SN74CBT3125C

QUADRUPLE FET BUS SWITCH

5-V BUS SWITCH WITH -2 -V UNDERSHOOT PROTECTION

SCDS122A – JULY 2003 – REVISED OCTOBER 2003

- Undershoot Protection for Off-Isolation on A and B Ports Up To -2 V
- Bidirectional Data Flow, With Near-Zero Propagation Delay
- Low ON-State Resistance (r_{ON}) Characteristics ($r_{ON} = 3 \Omega$ Typical)
- Low Input/Output Capacitance Minimizes Loading and Signal Distortion ($C_{io(OFF)} = 5$ pF Typical)
- Data and Control Inputs Provide Undershoot Clamp Diodes
- Low Power Consumption ($I_{CC} = 3 \mu A$ Max)
- V_{CC} Operating Range From 4 V to 5.5 V
- Data I/Os Support 0 to 5-V Signaling Levels (0.8-V, 1.2-V, 1.5-V, 1.8-V, 2.5-V, 3.3-V, 5-V)
- Control Inputs Can Be Driven by TTL or 5-V/3.3-V CMOS Outputs
- I_{off} Supports Partial-Power-Down Mode Operation
- Latch-Up Performance Exceeds 100 mA Per JESD 78, Class II
- ESD Performance Tested Per JESD 22
 - 2000-V Human-Body Model (A114-B, Class II)
 - 1000-V Charged-Device Model (C101)
- Supports Both Digital and Analog Applications: USB Interface, Bus Isolation, Low-Distortion Signal Gating

D, DB, DGV, OR PW PACKAGE
(TOP VIEW)

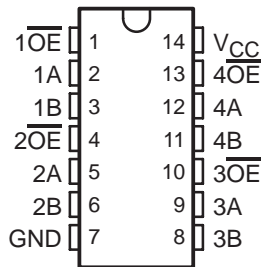

RGY PACKAGE
(TOP VIEW)

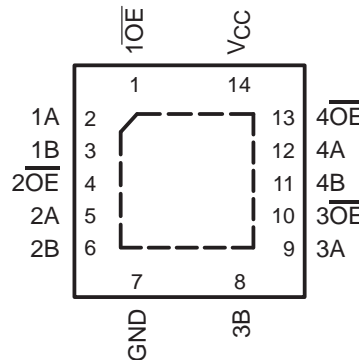

DBQ PACKAGE
(TOP VIEW)

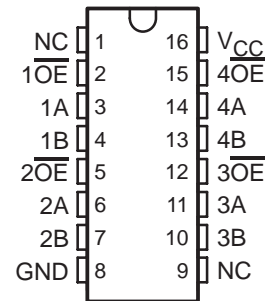

NC – No internal connection

description/ordering information

The SN74CBT3125C is a high-speed TTL-compatible FET bus switch with low ON-state resistance (r_{ON}), allowing for minimal propagation delay. Active Undershoot-Protection Circuitry on the A and B ports of the SN74CBT3125C provides protection for undershoot up to -2 V by sensing an undershoot event and ensuring that the switch remains in the proper OFF state.

The SN74CBT3125C is organized as four 1-bit bus switches with separate output-enable ($\overline{1OE}$, $\overline{2OE}$, $\overline{3OE}$, $\overline{4OE}$) inputs. It can be used as four 1-bit bus switches or as one 4-bit bus switch. When \overline{OE} is low, the associated 1-bit bus switch is ON, and the A port is connected to the B port, allowing bidirectional data flow between ports. When \overline{OE} is high, the associated 1-bit bus switch is OFF, and the high-impedance state exists between the A and B ports.

This device is fully specified for partial-power-down applications using I_{off} . The I_{off} feature ensures that damaging current will not backflow through the device when it is powered down. The device has isolation during power off.



Please be aware that an important notice concerning availability, standard warranty, and use in critical applications of Texas Instruments semiconductor products and disclaimers thereto appears at the end of this data sheet.

PRODUCTION DATA information is current as of publication date. Products conform to specifications per the terms of Texas Instruments standard warranty. Production processing does not necessarily include testing of all parameters.



POST OFFICE BOX 655303 • DALLAS, TEXAS 75265

Copyright © 2003, Texas Instruments Incorporated

SN74CBT3125C

QUADRUPLE FET BUS SWITCH

5-V BUS SWITCH WITH -2-V UNDERSHOOT PROTECTION

SCDS122A – JULY 2003 – REVISED OCTOBER 2003

description/ordering information (continued)

To ensure the high-impedance state during power up or power down, \overline{OE} should be tied to V_{CC} through a pullup resistor; the minimum value of the resistor is determined by the current-sinking capability of the driver.

ORDERING INFORMATION

T _A	PACKAGE†		ORDERABLE PART NUMBER	TOP-SIDE MARKING
-40°C to 85°C	QFN – RGY	Tape and reel	SN74CBT3125CRGYR	CU125C
	SOIC – D	Tube	SN74CBT3125CD	CBT3125C
		Tape and reel	SN74CBT3125CDR	
	SSOP – DB	Tube	SN74CBT3125CDB	CU125C
		Tape and reel	SN74CBT3125CDBR	
	SSOP (QSOP) – DBQ	Tape and reel	SN74CBT3125CDBQR	CU125C
	TSSOP – PW	Tube	SN74CBT3125CPW	CU125C
		Tape and reel	SN74CBT3125CPWR	
TVSOP – DGV	Tape and reel	SN74CBT3125CDGVR	CU125C	

† Package drawings, standard packing quantities, thermal data, symbolization, and PCB design guidelines are available at www.ti.com/sc/package.

FUNCTION TABLE (each bus switch)

INPUT \overline{OE}	INPUT/OUTPUT A	FUNCTION
L	B	A port = B port
H	Z	Disconnect

logic diagram (positive logic)

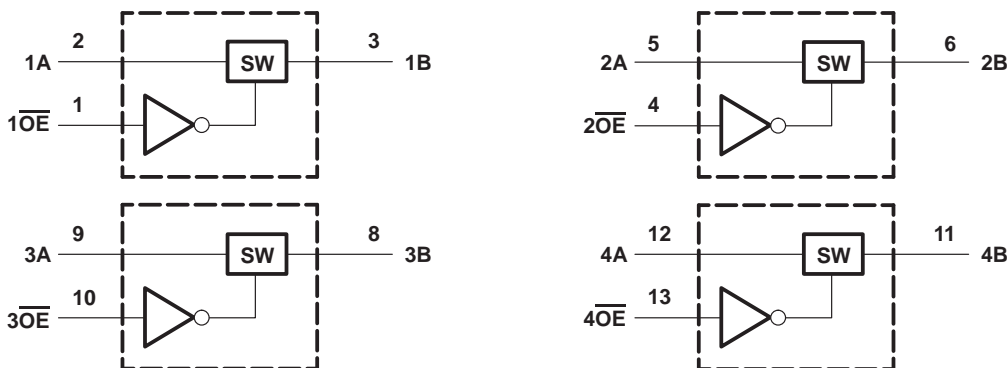

Pin numbers shown are for the D, DB, DGV, PW, and RGY packages.

simplified schematic, each FET switch (SW)

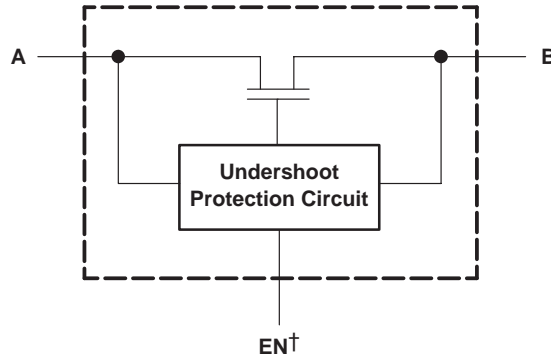

† EN is the internal enable signal applied to the switch.

absolute maximum ratings over operating free-air temperature range (unless otherwise noted)‡

Supply voltage range, V_{CC}	-0.5 V to 7 V
Control input voltage range, V_{IN} (see Notes 1 and 2)	-0.5 V to 7 V
Switch I/O voltage range, $V_{I/O}$ (see Notes 1, 2, and 3)	-0.5 V to 7 V
Control input clamp current, I_{IK} ($V_{IN} < 0$)	-50 mA
I/O port clamp current, $I_{I/OK}$ ($V_{I/O} < 0$)	-50 mA
ON-state switch current, $I_{I/O}$ (see Note 4)	± 128 mA
Continuous current through V_{CC} or GND terminals	± 100 mA
Package thermal impedance, θ_{JA} (see Note 5): D package	86°C/W
(see Note 5): DB package	96°C/W
(see Note 5): DBQ package	90°C/W
(see Note 5): DGV package	127°C/W
(see Note 5): PW package	113°C/W
(see Note 6): RGY package	47°C/W
Storage temperature range, T_{stg}	-65°C to 150°C

‡ Stresses beyond those listed under “absolute maximum ratings” may cause permanent damage to the device. These are stress ratings only, and functional operation of the device at these or any other conditions beyond those indicated under “recommended operating conditions” is not implied. Exposure to absolute-maximum-rated conditions for extended periods may affect device reliability.

- NOTES:
1. All voltages are with respect to ground unless otherwise specified.
 2. The input and output voltage ratings may be exceeded if the input and output clamp-current ratings are observed.
 3. V_I and V_O are used to denote specific conditions for $V_{I/O}$.
 4. I_I and I_O are used to denote specific conditions for $I_{I/O}$.
 5. The package thermal impedance is calculated in accordance with JESD 51-7.
 6. The package thermal impedance is calculated in accordance with JESD 51-5.

recommended operating conditions (see Note 7)

	MIN	MAX	UNIT
V_{CC} Supply voltage	4	5.5	V
V_{IH} High-level control input voltage	2	5.5	V
V_{IL} Low-level control input voltage	0	0.8	V
$V_{I/O}$ Data input/output voltage	0	5.5	V
T_A Operating free-air temperature	-40	85	°C

NOTE 7: All unused control inputs of the device must be held at V_{CC} or GND to ensure proper device operation. Refer to the TI application report, *Implications of Slow or Floating CMOS Inputs*, literature number SCBA004.

SN74CBT3125C

QUADRUPLE FET BUS SWITCH

5-V BUS SWITCH WITH -2-V UNDERSHOOT PROTECTION

SCDS122A – JULY 2003 – REVISED OCTOBER 2003

electrical characteristics over recommended operating free-air temperature range (unless otherwise noted)

PARAMETER		TEST CONDITIONS		MIN	TYP†	MAX	UNIT
V _{IK}	Control inputs	V _{CC} = 4.5 V,	I _{IN} = -18 mA			-1.8	V
V _{IKU}	Data inputs	V _{CC} = 5 V,	0 mA > I _I ≥ -50 mA, V _{IN} = V _{CC} or GND, Switch OFF			-2	V
I _{IN}	Control inputs	V _{CC} = 5.5 V,	V _{IN} = V _{CC} or GND			±1	μA
I _{OZ} ‡		V _{CC} = 5.5 V,	V _O = 0 to 5.5 V, V _I = 0, Switch OFF, V _{IN} = V _{CC} or GND			±10	μA
I _{off}		V _{CC} = 0,	V _O = 0 to 5.5 V, V _I = 0			10	μA
I _{CC}		V _{CC} = 5.5 V,	I _{I/O} = 0, V _{IN} = V _{CC} or GND, Switch ON or OFF			3	μA
ΔI _{CC} §	Control inputs	V _{CC} = 5.5 V,	One input at 3.4 V, Other inputs at V _{CC} or GND			2.5	mA
C _{in}	Control inputs	V _{IN} = 3 V or 0			3		pF
C _{io} (OFF)		V _{I/O} = 3 V or 0, Switch OFF,	V _{IN} = V _{CC} or GND		5		pF
C _{io} (ON)		V _{I/O} = 3 V or 0, Switch ON,	V _{IN} = V _{CC} or GND		12.5		pF
r _{on} ¶		V _{CC} = 4 V, TYP at V _{CC} = 4 V	V _I = 2.4 V, I _O = -15 mA	8	12	Ω	
			V _I = 0, I _O = 64 mA	3	6		
		V _{CC} = 4.5 V	V _I = 0, I _O = 30 mA	3	6		
			V _I = 2.4 V, I _O = -15 mA	5	10		

V_{IN} and I_{IN} refer to control inputs. V_I, V_O, I_I, and I_O refer to data pins.

† All typical values are at V_{CC} = 5 V (unless otherwise noted), T_A = 25°C.

‡ For I/O ports, the parameter I_{OZ} includes the input leakage current.

§ This is the increase in supply current for each input that is at the specified voltage level, rather than V_{CC} or GND.

¶ Measured by the voltage drop between the A and B terminals at the indicated current through the switch. ON-state resistance is determined by the lower of the voltages of the two (A or B) terminals.

switching characteristics over recommended operating free-air temperature range (unless otherwise noted) (see Figure 3)

PARAMETER	FROM (INPUT)	TO (OUTPUT)	V _{CC} = 4 V		V _{CC} = 5 V ± 0.5 V		UNIT
			MIN	MAX	MIN	MAX	
t _{pd} #	A or B	B or A	0.24		0.15		ns
t _{en}	$\overline{\text{OE}}$	A or B	4.4		1.5	4	ns
t _{dis}	$\overline{\text{OE}}$	A or B	4.4		1.5	4.4	ns

The propagation delay is the calculated RC time constant of the typical ON-state resistance of the switch and the specified load capacitance, when driven by an ideal voltage source (zero output impedance).



SN74CBT3125C QUADRUPLE FET BUS SWITCH 5-V BUS SWITCH WITH -2-V UNDERSHOOT PROTECTION

SCDS122A – JULY 2003 – REVISED OCTOBER 2003

undershoot characteristics (see Figures 1 and 2)

PARAMETER	TEST CONDITIONS	MIN	TYP†	MAX	UNIT
V_{OUTU}	$V_{CC} = 5.5\text{ V}$, Switch OFF, $V_{IN} = V_{CC}$ or GND	2	$V_{OH} - 0.3$		V

† All typical values are at $V_{CC} = 5\text{ V}$ (unless otherwise noted), $T_A = 25^\circ\text{C}$.

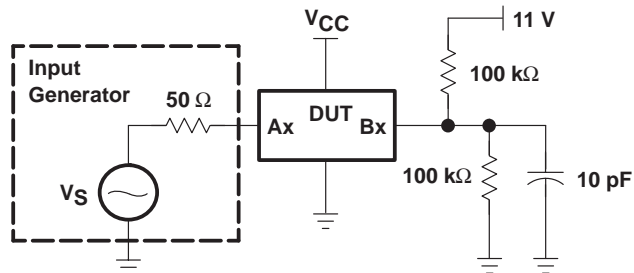

Figure 1. Device Test Setup

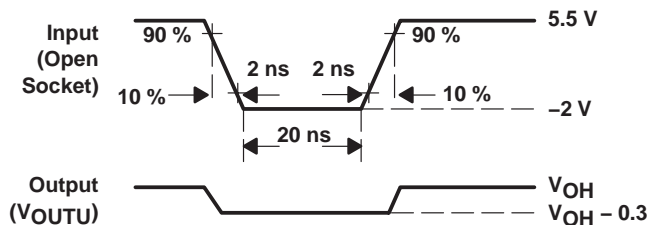
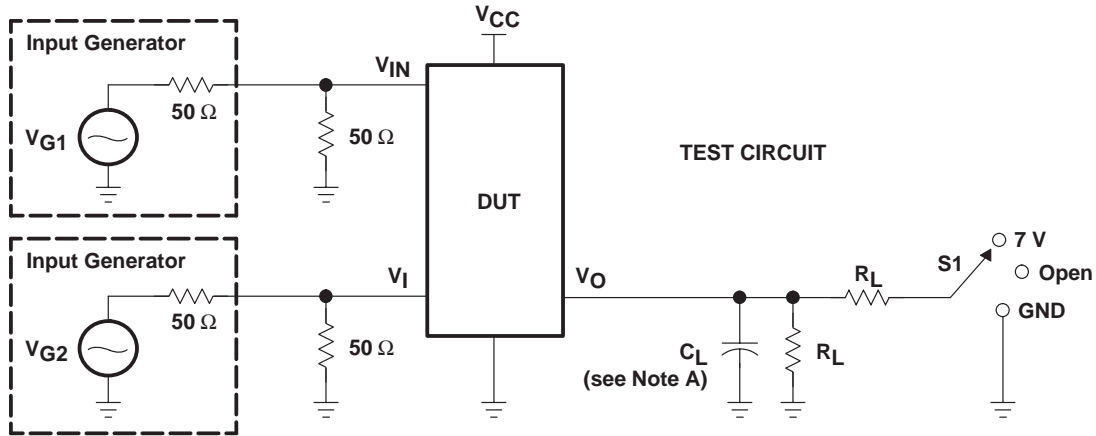

Figure 2. Transient Input Voltage (V_i) and Output Voltage (V_{OUTU}) Waveforms (Switch OFF)

SN74CBT3125C
QUADRUPLE FET BUS SWITCH
5-V BUS SWITCH WITH -2-V UNDERSHOOT PROTECTION

SCDS122A – JULY 2003 – REVISED OCTOBER 2003

PARAMETER MEASUREMENT INFORMATION



TEST	VCC	S1	RL	VI	CL	VΔ
t _{pd} (s)	5 V ± 0.5 V	Open	500 Ω	VCC or GND	50 pF	
	4 V	Open	500 Ω	VCC or GND	50 pF	
t _{PLZ} /t _{PZL}	5 V ± 0.5 V	7 V	500 Ω	GND	50 pF	0.3 V
	4 V	7 V	500 Ω	GND	50 pF	0.3 V
t _{PHZ} /t _{PZH}	5 V ± 0.5 V	Open	500 Ω	VCC	50 pF	0.3 V
	4 V	Open	500 Ω	VCC	50 pF	0.3 V



- NOTES:
- A. C_L includes probe and jig capacitance.
 - B. Waveform 1 is for an output with internal conditions such that the output is low except when disabled by the output control. Waveform 2 is for an output with internal conditions such that the output is high except when disabled by the output control.
 - C. All input pulses are supplied by generators having the following characteristics: PRR ≤ 10 MHz, Z_O = 50 Ω, t_r ≤ 2.5 ns, t_f ≤ 2.5 ns.
 - D. The outputs are measured one at a time with one transition per measurement.
 - E. t_{PLZ} and t_{PHZ} are the same as t_{dis}.
 - F. t_{PZL} and t_{PZH} are the same as t_{en}.
 - G. t_{PLH} and t_{PHL} are the same as t_{pd}(s). The t_{pd} propagation delay is the calculated RC time constant of the typical ON-state resistance of the switch and the specified load capacitance, when driven by an ideal voltage source (zero output impedance).
 - H. All parameters and waveforms are not applicable to all devices.

Figure 3. Test Circuit and Voltage Waveforms

PACKAGING INFORMATION

Orderable Device	Status ⁽¹⁾	Package Type	Package Drawing	Pins	Package Qty	Eco Plan ⁽²⁾	Lead/ Ball Finish	MSL Peak Temp ⁽³⁾	Samples (Requires Login)
SN74CBT3125CD	ACTIVE	SOIC	D	14	50	Green (RoHS & no Sb/Br)	CU NIPDAU	Level-1-260C-UNLIM	Purchase Samples
SN74CBT3125CDBQR	ACTIVE	SSOP/QSOP	DBQ	16	2500	Green (RoHS & no Sb/Br)	CU NIPDAU	Level-2-260C-1 YEAR	Contact TI Distributor or Sales Office
SN74CBT3125CDBQRE4	ACTIVE	SSOP/QSOP	DBQ	16	2500	Green (RoHS & no Sb/Br)	CU NIPDAU	Level-2-260C-1 YEAR	Contact TI Distributor or Sales Office
SN74CBT3125CDBQRG4	ACTIVE	SSOP/QSOP	DBQ	16	2500	Green (RoHS & no Sb/Br)	CU NIPDAU	Level-2-260C-1 YEAR	Contact TI Distributor or Sales Office
SN74CBT3125CDBR	ACTIVE	SSOP	DB	14	2000	Green (RoHS & no Sb/Br)	CU NIPDAU	Level-1-260C-UNLIM	Contact TI Distributor or Sales Office
SN74CBT3125CDBRE4	ACTIVE	SSOP	DB	14	2000	Green (RoHS & no Sb/Br)	CU NIPDAU	Level-1-260C-UNLIM	Contact TI Distributor or Sales Office
SN74CBT3125CDBRG4	ACTIVE	SSOP	DB	14	2000	Green (RoHS & no Sb/Br)	CU NIPDAU	Level-1-260C-UNLIM	Contact TI Distributor or Sales Office
SN74CBT3125CDE4	ACTIVE	SOIC	D	14	50	Green (RoHS & no Sb/Br)	CU NIPDAU	Level-1-260C-UNLIM	Purchase Samples
SN74CBT3125CDG4	ACTIVE	SOIC	D	14	50	Green (RoHS & no Sb/Br)	CU NIPDAU	Level-1-260C-UNLIM	Purchase Samples
SN74CBT3125CDGVR	ACTIVE	TVSOP	DGV	14	2000	Green (RoHS & no Sb/Br)	CU NIPDAU	Level-1-260C-UNLIM	Contact TI Distributor or Sales Office
SN74CBT3125CDGVRE4	ACTIVE	TVSOP	DGV	14	2000	Green (RoHS & no Sb/Br)	CU NIPDAU	Level-1-260C-UNLIM	Contact TI Distributor or Sales Office
SN74CBT3125CDGVRG4	ACTIVE	TVSOP	DGV	14	2000	Green (RoHS & no Sb/Br)	CU NIPDAU	Level-1-260C-UNLIM	Contact TI Distributor or Sales Office
SN74CBT3125CDR	ACTIVE	SOIC	D	14	2500	Green (RoHS & no Sb/Br)	CU NIPDAU	Level-1-260C-UNLIM	Contact TI Distributor or Sales Office
SN74CBT3125CDRE4	ACTIVE	SOIC	D	14	2500	Green (RoHS & no Sb/Br)	CU NIPDAU	Level-1-260C-UNLIM	Contact TI Distributor or Sales Office
SN74CBT3125CDRG4	ACTIVE	SOIC	D	14	2500	Green (RoHS & no Sb/Br)	CU NIPDAU	Level-1-260C-UNLIM	Contact TI Distributor or Sales Office
SN74CBT3125CPW	ACTIVE	TSSOP	PW	14	90	Green (RoHS & no Sb/Br)	CU NIPDAU	Level-1-260C-UNLIM	Purchase Samples
SN74CBT3125CPWE4	ACTIVE	TSSOP	PW	14	90	Green (RoHS & no Sb/Br)	CU NIPDAU	Level-1-260C-UNLIM	Purchase Samples

Orderable Device	Status ⁽¹⁾	Package Type	Package Drawing	Pins	Package Qty	Eco Plan ⁽²⁾	Lead/ Ball Finish	MSL Peak Temp ⁽³⁾	Samples (Requires Login)
SN74CBT3125CPWG4	ACTIVE	TSSOP	PW	14	90	Green (RoHS & no Sb/Br)	CU NIPDAU	Level-1-260C-UNLIM	Purchase Samples
SN74CBT3125CPWR	ACTIVE	TSSOP	PW	14	2000	Green (RoHS & no Sb/Br)	CU NIPDAU	Level-1-260C-UNLIM	Contact TI Distributor or Sales Office
SN74CBT3125CPWRE4	ACTIVE	TSSOP	PW	14	2000	Green (RoHS & no Sb/Br)	CU NIPDAU	Level-1-260C-UNLIM	Contact TI Distributor or Sales Office
SN74CBT3125CPWRG4	ACTIVE	TSSOP	PW	14	2000	Green (RoHS & no Sb/Br)	CU NIPDAU	Level-1-260C-UNLIM	Contact TI Distributor or Sales Office
SN74CBT3125CRGYR	ACTIVE	VQFN	RGY	14	3000	Green (RoHS & no Sb/Br)	CU NIPDAU	Level-2-260C-1 YEAR	Contact TI Distributor or Sales Office
SN74CBT3125CRGYRG4	ACTIVE	VQFN	RGY	14	3000	Green (RoHS & no Sb/Br)	CU NIPDAU	Level-2-260C-1 YEAR	Contact TI Distributor or Sales Office

⁽¹⁾ The marketing status values are defined as follows:

ACTIVE: Product device recommended for new designs.

LIFEBUY: TI has announced that the device will be discontinued, and a lifetime-buy period is in effect.

NRND: Not recommended for new designs. Device is in production to support existing customers, but TI does not recommend using this part in a new design.

PREVIEW: Device has been announced but is not in production. Samples may or may not be available.

OBSOLETE: TI has discontinued the production of the device.

⁽²⁾ Eco Plan - The planned eco-friendly classification: Pb-Free (RoHS), Pb-Free (RoHS Exempt), or Green (RoHS & no Sb/Br) - please check <http://www.ti.com/productcontent> for the latest availability information and additional product content details.

TBD: The Pb-Free/Green conversion plan has not been defined.

Pb-Free (RoHS): TI's terms "Lead-Free" or "Pb-Free" mean semiconductor products that are compatible with the current RoHS requirements for all 6 substances, including the requirement that lead not exceed 0.1% by weight in homogeneous materials. Where designed to be soldered at high temperatures, TI Pb-Free products are suitable for use in specified lead-free processes.

Pb-Free (RoHS Exempt): This component has a RoHS exemption for either 1) lead-based flip-chip solder bumps used between the die and package, or 2) lead-based die adhesive used between the die and leadframe. The component is otherwise considered Pb-Free (RoHS compatible) as defined above.

Green (RoHS & no Sb/Br): TI defines "Green" to mean Pb-Free (RoHS compatible), and free of Bromine (Br) and Antimony (Sb) based flame retardants (Br or Sb do not exceed 0.1% by weight in homogeneous material)

⁽³⁾ MSL, Peak Temp. -- The Moisture Sensitivity Level rating according to the JEDEC industry standard classifications, and peak solder temperature.

Important Information and Disclaimer: The information provided on this page represents TI's knowledge and belief as of the date that it is provided. TI bases its knowledge and belief on information provided by third parties, and makes no representation or warranty as to the accuracy of such information. Efforts are underway to better integrate information from third parties. TI has taken and continues to take reasonable steps to provide representative and accurate information but may not have conducted destructive testing or chemical analysis on incoming materials and chemicals. TI and TI suppliers consider certain information to be proprietary, and thus CAS numbers and other limited information may not be available for release.

In no event shall TI's liability arising out of such information exceed the total purchase price of the TI part(s) at issue in this document sold by TI to Customer on an annual basis.

TAPE AND REEL INFORMATION

QUADRANT ASSIGNMENTS FOR PIN 1 ORIENTATION IN TAPE

*All dimensions are nominal

Device	Package Type	Package Drawing	Pins	SPQ	Reel Diameter (mm)	Reel Width W1 (mm)	A0 (mm)	B0 (mm)	K0 (mm)	P1 (mm)	W (mm)	Pin1 Quadrant
SN74CBT3125CDBR	SSOP	DB	14	2000	330.0	16.4	8.2	6.6	2.5	12.0	16.0	Q1
SN74CBT3125CDGVR	TVSOP	DGV	14	2000	330.0	12.4	6.8	4.0	1.6	8.0	12.0	Q1
SN74CBT3125CDR	SOIC	D	14	2500	330.0	16.4	6.5	9.0	2.1	8.0	16.0	Q1
SN74CBT3125CPWR	TSSOP	PW	14	2000	330.0	12.4	6.9	5.6	1.6	8.0	12.0	Q1
SN74CBT3125CRGYR	VQFN	RGY	14	3000	330.0	12.4	3.75	3.75	1.15	8.0	12.0	Q1

TAPE AND REEL BOX DIMENSIONS

*All dimensions are nominal

Device	Package Type	Package Drawing	Pins	SPQ	Length (mm)	Width (mm)	Height (mm)
SN74CBT3125CDBR	SSOP	DB	14	2000	346.0	346.0	33.0
SN74CBT3125CDGVR	TVSOP	DGV	14	2000	346.0	346.0	29.0
SN74CBT3125CDR	SOIC	D	14	2500	333.2	345.9	28.6
SN74CBT3125CPWR	TSSOP	PW	14	2000	346.0	346.0	29.0
SN74CBT3125CRGYR	VQFN	RGY	14	3000	346.0	346.0	29.0

DGV (R-PDSO-G**)

PLASTIC SMALL-OUTLINE

24 PINS SHOWN





4073251/E 08/00

- NOTES: A. All linear dimensions are in millimeters.
 B. This drawing is subject to change without notice.
 C. Body dimensions do not include mold flash or protrusion, not to exceed 0,15 per side.
 D. Falls within JEDEC: 24/48 Pins – MO-153
 14/16/20/56 Pins – MO-194

D (R-PDSO-G14)

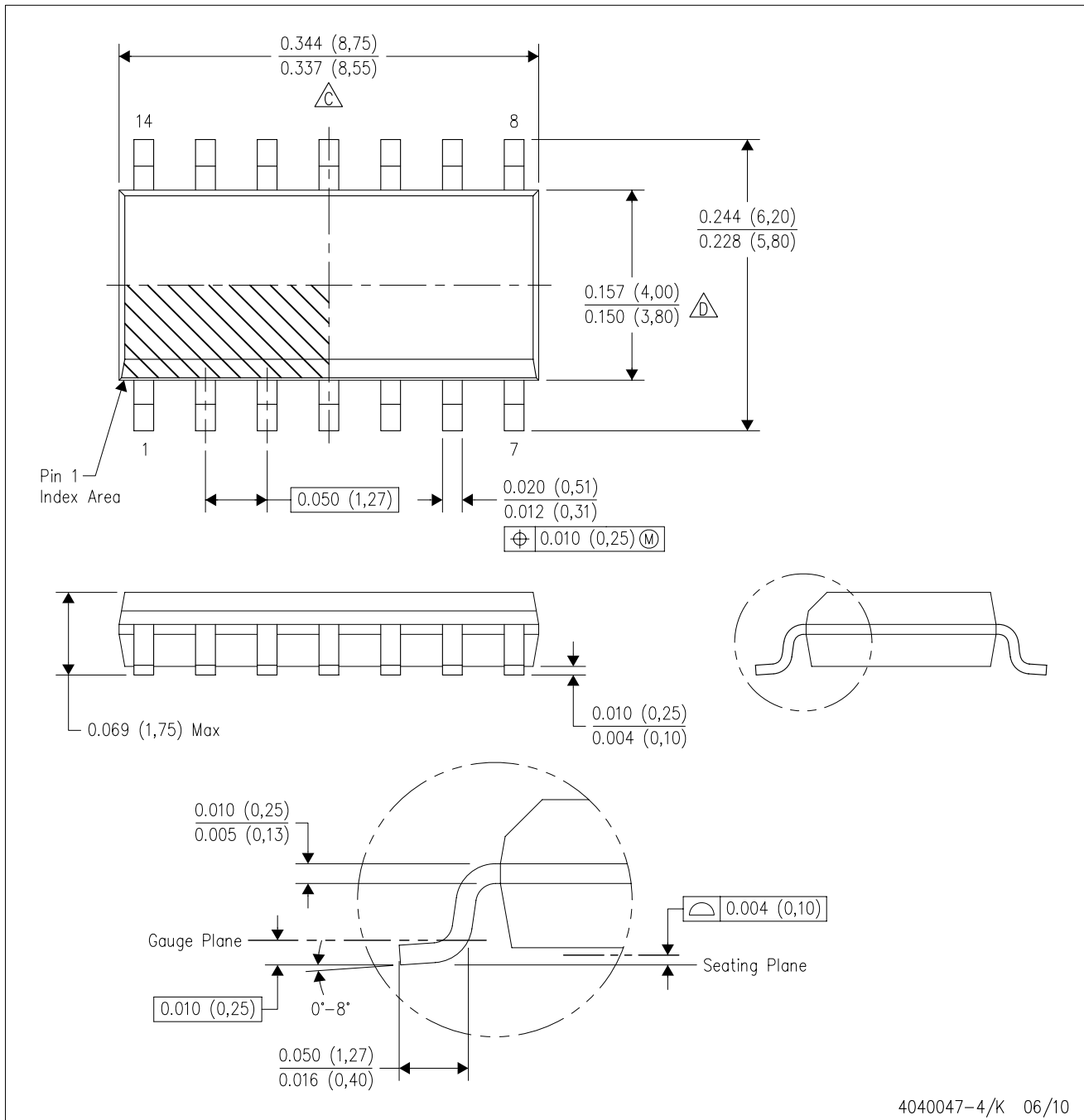
PLASTIC SMALL-OUTLINE PACKAGE



- NOTES:
- A. All linear dimensions are in inches (millimeters).
 - B. This drawing is subject to change without notice.
 -  Body length does not include mold flash, protrusions, or gate burrs. Mold flash, protrusions, or gate burrs shall not exceed .006 (0,15) per end.
 -  Body width does not include interlead flash. Interlead flash shall not exceed .017 (0,43) per side.
 - E. Reference JEDEC MS-012 variation AB.

D (R-PDSO-G14)

PLASTIC SMALL OUTLINE

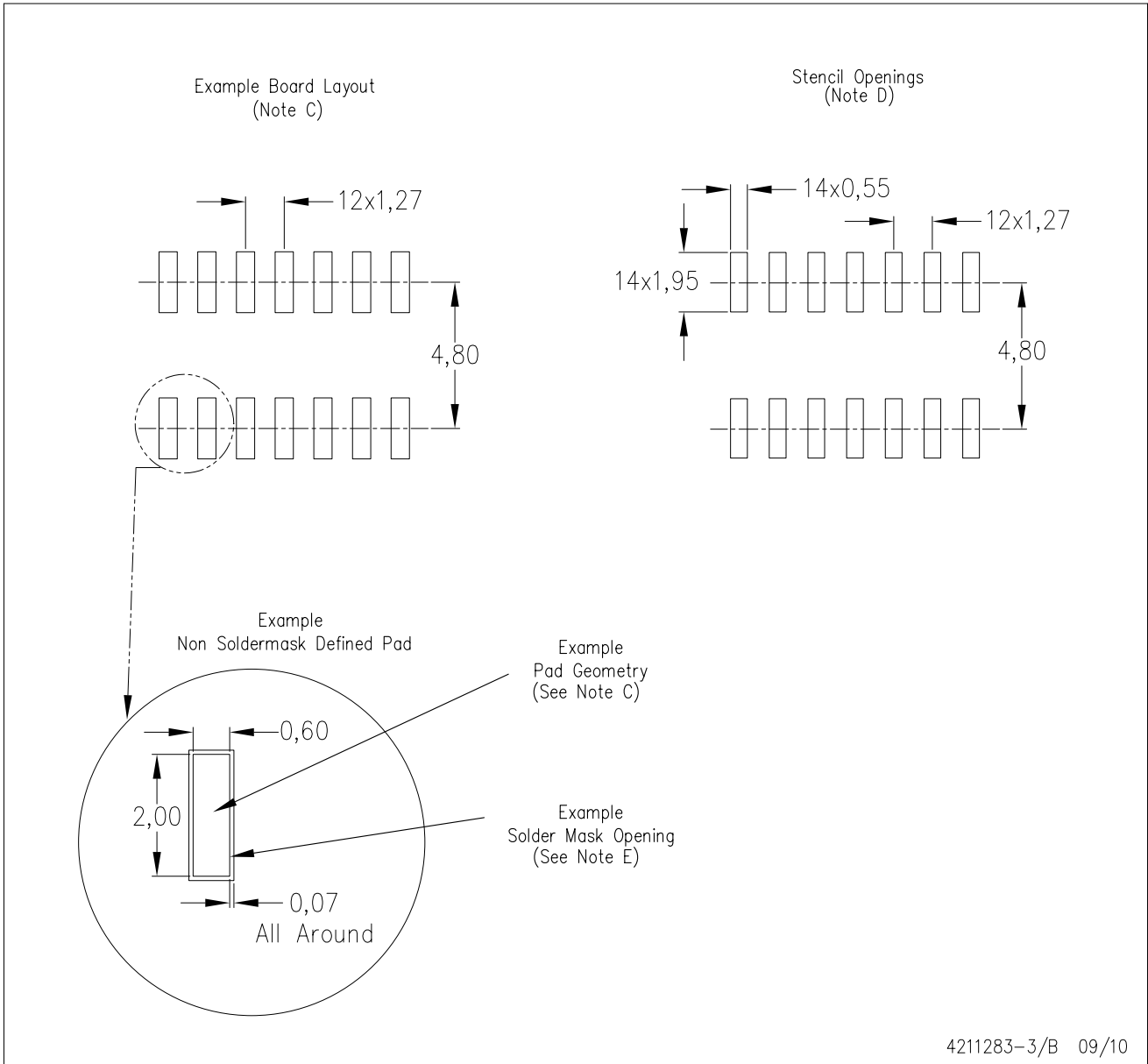



- NOTES:
- A. All linear dimensions are in millimeters.
 - B. This drawing is subject to change without notice.
 - C. Publication IPC-7351 is recommended for alternate designs.
 - D. Laser cutting apertures with trapezoidal walls and also rounding corners will offer better paste release. Customers should contact their board assembly site for stencil design recommendations. Refer to IPC-7525 for other stencil recommendations.
 - E. Customers should contact their board fabrication site for solder mask tolerances between and around signal pads.

RGY (S-PVQFN-N14)

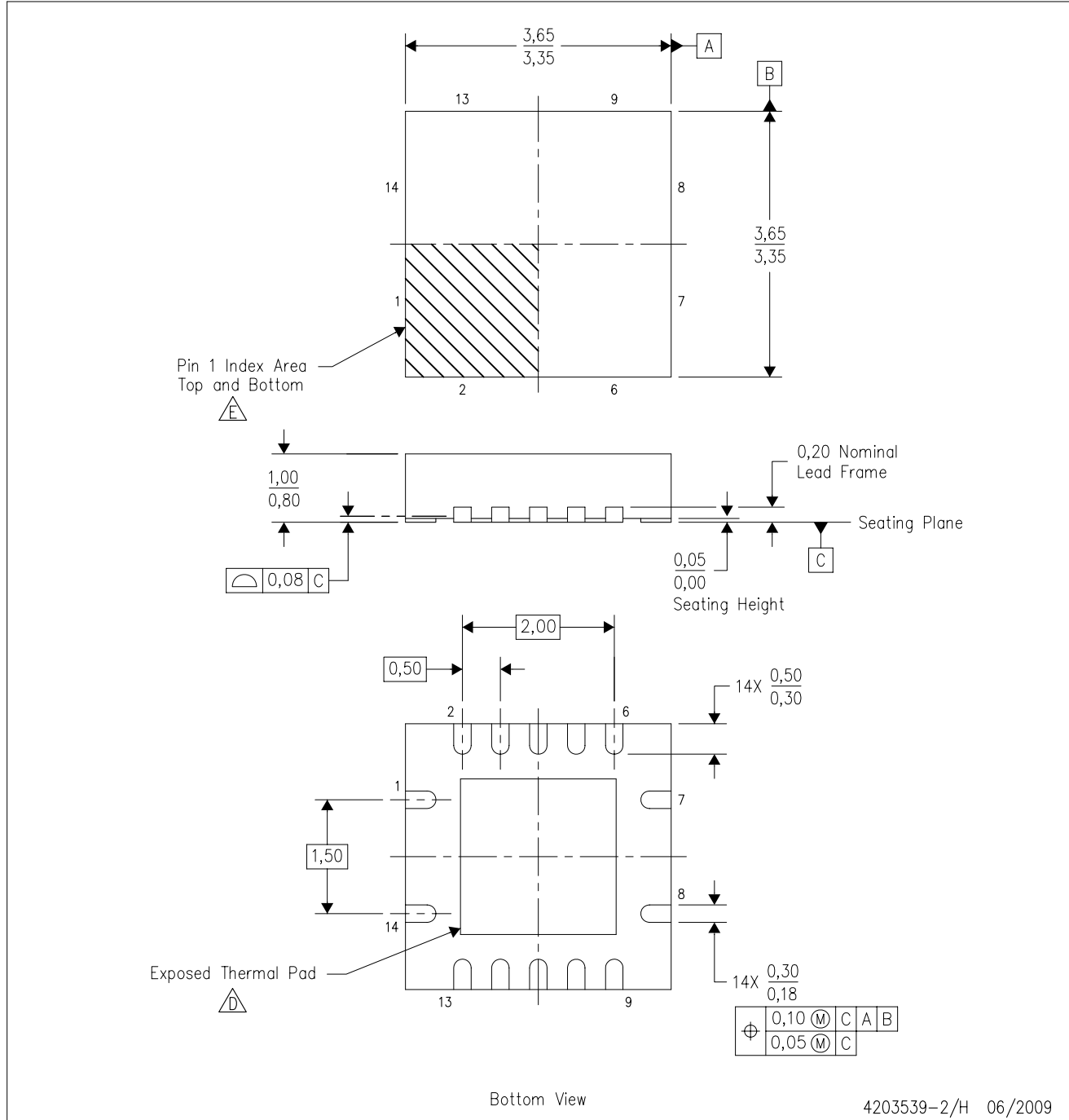
PLASTIC QUAD FLATPACK NO-LEAD



- NOTES:
- A. All linear dimensions are in millimeters. Dimensioning and tolerancing per ASME Y14.5M-1994.
 - B. This drawing is subject to change without notice.
 - C. QFN (Quad Flatpack No-Lead) package configuration.
 -  The package thermal pad must be soldered to the board for thermal and mechanical performance. See the Product Data Sheet for details regarding the exposed thermal pad dimensions.
 -  Pin 1 identifiers are located on both top and bottom of the package and within the zone indicated. The Pin 1 identifiers are either a molded, marked, or metal feature.
 - F. Package complies to JEDEC MO-241 variation BA.

THERMAL PAD MECHANICAL DATA

RGY (S-PVQFN-N14)

PLASTIC QUAD FLATPACK NO-LEAD

THERMAL INFORMATION

This package incorporates an exposed thermal pad that is designed to be attached directly to an external heatsink. The thermal pad must be soldered directly to the printed circuit board (PCB). After soldering, the PCB can be used as a heatsink. In addition, through the use of thermal vias, the thermal pad can be attached directly to the appropriate copper plane shown in the electrical schematic for the device, or alternatively, can be attached to a special heatsink structure designed into the PCB. This design optimizes the heat transfer from the integrated circuit (IC).

For information on the Quad Flatpack No-Lead (QFN) package and its advantages, refer to Application Report, QFN/SON PCB Attachment, Texas Instruments Literature No. SLUA271. This document is available at www.ti.com.

The exposed thermal pad dimensions for this package are shown in the following illustration.

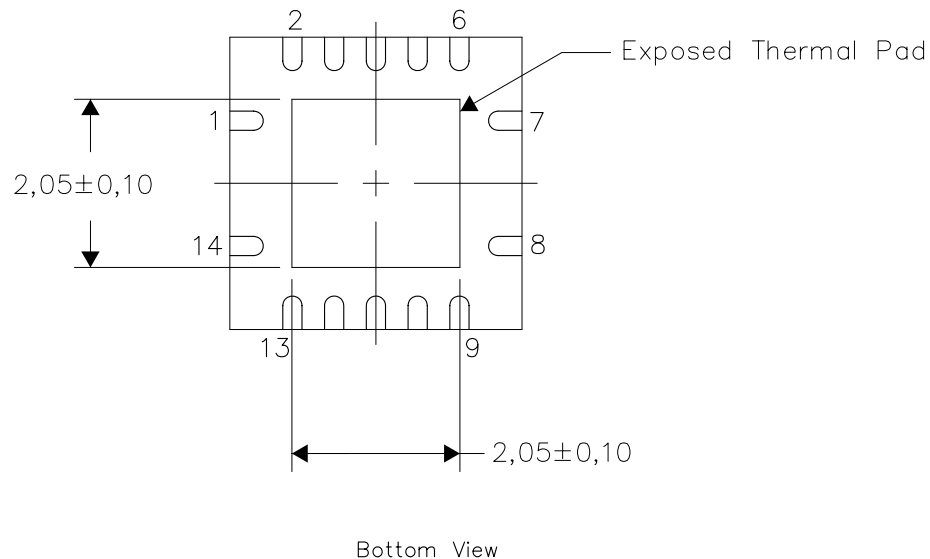

NOTES: All linear dimensions are in millimeters

Exposed Thermal Pad Dimensions

4206353-2/L 08/10

RGY (S-PVQFN-N14)

PLASTIC QUAD FLATPACK NO-LEAD

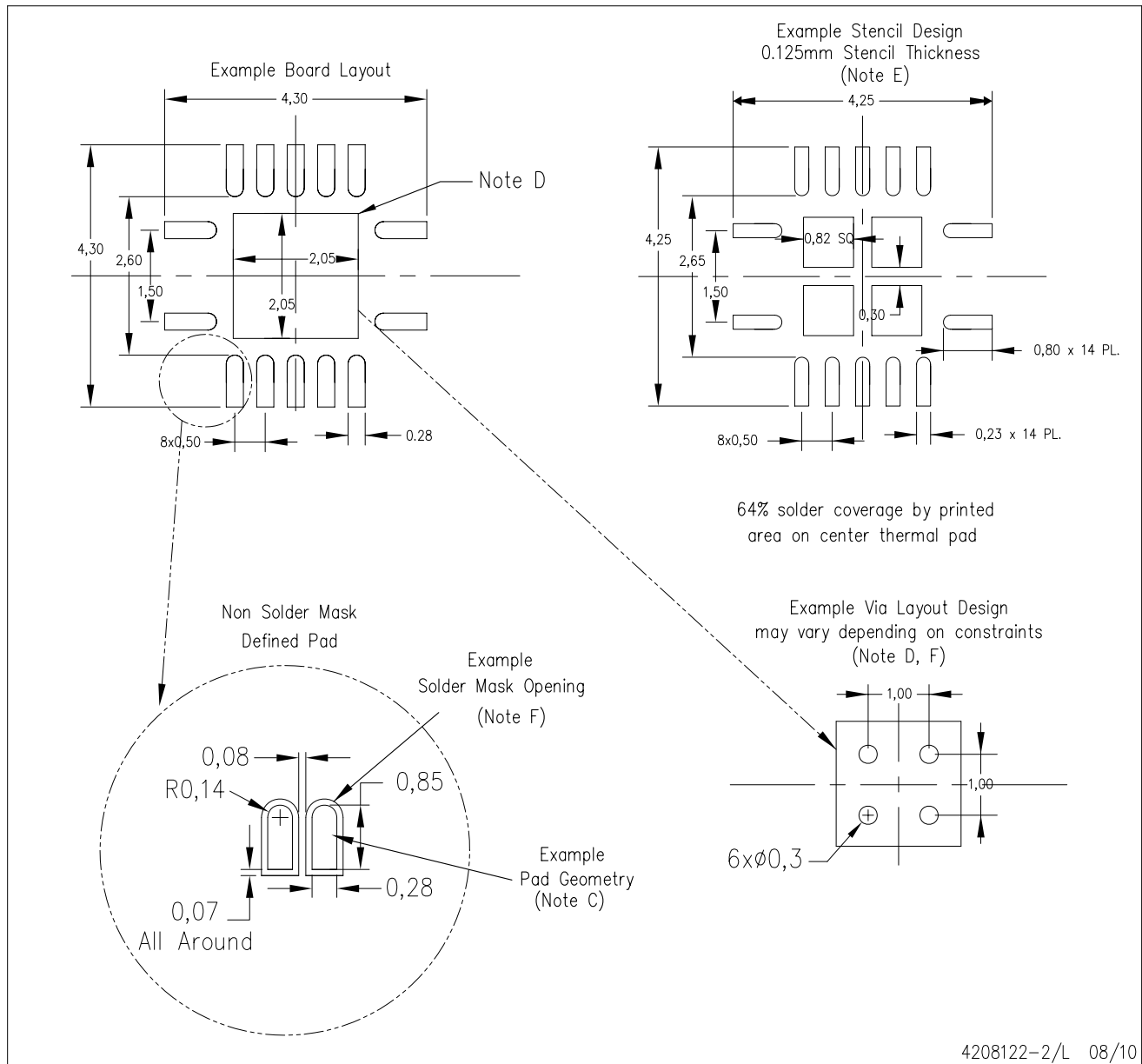

- NOTES:
- All linear dimensions are in millimeters.
 - This drawing is subject to change without notice.
 - Publication IPC-7351 is recommended for alternate designs.
 - This package is designed to be soldered to a thermal pad on the board. Refer to Application Note, Quad Flat-Pack QFN/SON PCB Attachment, Texas Instruments Literature No. SLUA271, and also the Product Data Sheets for specific thermal information, via requirements, and recommended board layout. These documents are available at www.ti.com <<http://www.ti.com>>.
 - Laser cutting apertures with trapezoidal walls and also rounding corners will offer better paste release. Customers should contact their board assembly site for stencil design recommendations. Refer to IPC 7525 for stencil design considerations.
 - Customers should contact their board fabrication site for minimum solder mask web tolerances between signal pads.

DB (R-PDSO-G**)

PLASTIC SMALL-OUTLINE

28 PINS SHOWN



- NOTES: A. All linear dimensions are in millimeters.
 B. This drawing is subject to change without notice.
 C. Body dimensions do not include mold flash or protrusion not to exceed 0,15.
 D. Falls within JEDEC MO-150

PW (R-PDSO-G**)

PLASTIC SMALL-OUTLINE PACKAGE

14 PINS SHOWN



4040064/F 01/97

- NOTES: A. All linear dimensions are in millimeters.
 B. This drawing is subject to change without notice.
 C. Body dimensions do not include mold flash or protrusion not to exceed 0,15.
 D. Falls within JEDEC MO-153

PW (R-PDSO-G14)

PLASTIC SMALL OUTLINE

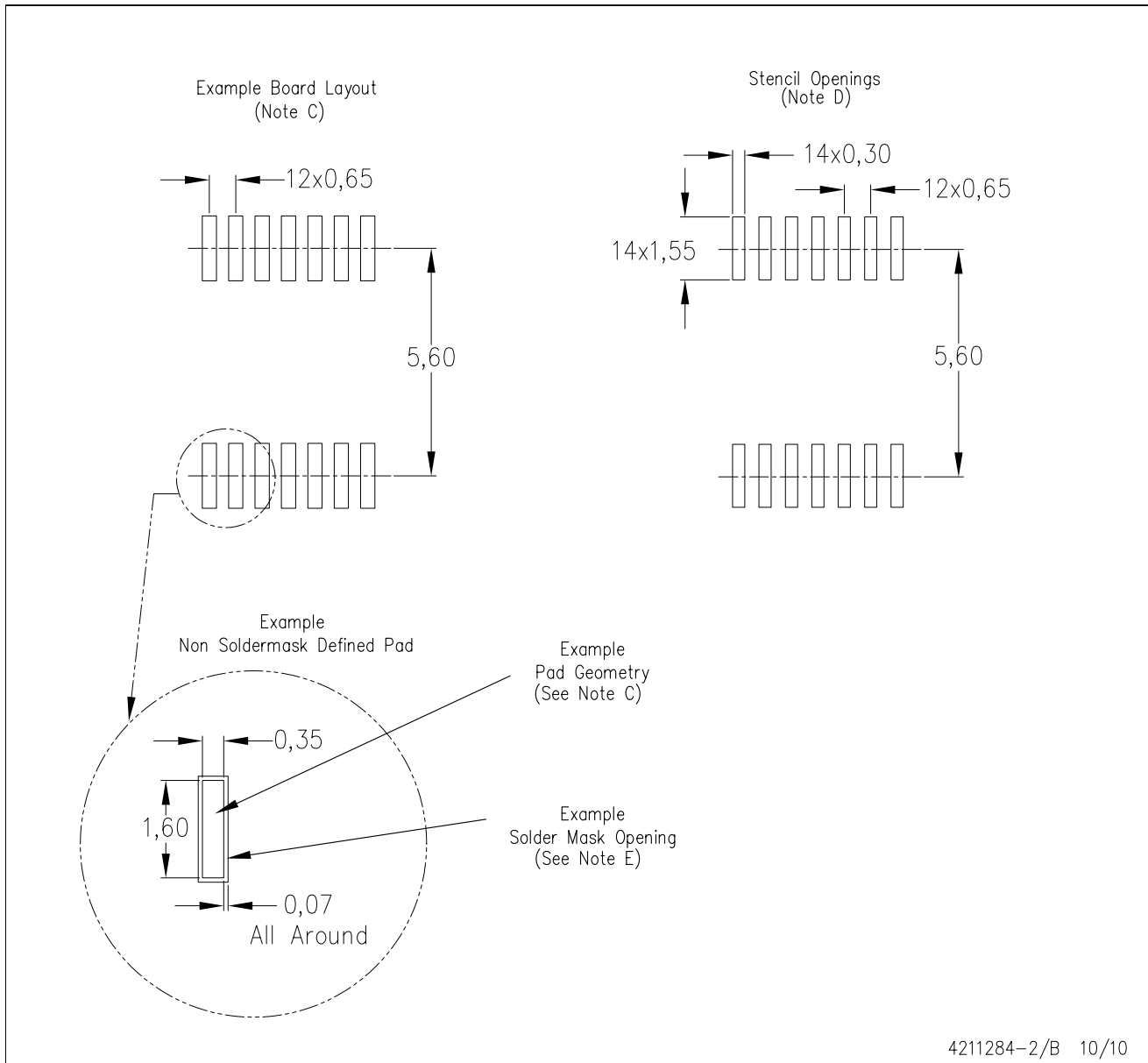

- NOTES:
- All linear dimensions are in millimeters.
 - This drawing is subject to change without notice.
 - Publication IPC-7351 is recommended for alternate designs.
 - Laser cutting apertures with trapezoidal walls and also rounding corners will offer better paste release. Customers should contact their board assembly site for stencil design recommendations. Refer to IPC-7525 for other stencil recommendations.
 - Customers should contact their board fabrication site for solder mask tolerances between and around signal pads.

IMPORTANT NOTICE

Texas Instruments Incorporated and its subsidiaries (TI) reserve the right to make corrections, modifications, enhancements, improvements, and other changes to its products and services at any time and to discontinue any product or service without notice. Customers should obtain the latest relevant information before placing orders and should verify that such information is current and complete. All products are sold subject to TI's terms and conditions of sale supplied at the time of order acknowledgment.

TI warrants performance of its hardware products to the specifications applicable at the time of sale in accordance with TI's standard warranty. Testing and other quality control techniques are used to the extent TI deems necessary to support this warranty. Except where mandated by government requirements, testing of all parameters of each product is not necessarily performed.

TI assumes no liability for applications assistance or customer product design. Customers are responsible for their products and applications using TI components. To minimize the risks associated with customer products and applications, customers should provide adequate design and operating safeguards.

TI does not warrant or represent that any license, either express or implied, is granted under any TI patent right, copyright, mask work right, or other TI intellectual property right relating to any combination, machine, or process in which TI products or services are used. Information published by TI regarding third-party products or services does not constitute a license from TI to use such products or services or a warranty or endorsement thereof. Use of such information may require a license from a third party under the patents or other intellectual property of the third party, or a license from TI under the patents or other intellectual property of TI.

Reproduction of TI information in TI data books or data sheets is permissible only if reproduction is without alteration and is accompanied by all associated warranties, conditions, limitations, and notices. Reproduction of this information with alteration is an unfair and deceptive business practice. TI is not responsible or liable for such altered documentation. Information of third parties may be subject to additional restrictions.

Resale of TI products or services with statements different from or beyond the parameters stated by TI for that product or service voids all express and any implied warranties for the associated TI product or service and is an unfair and deceptive business practice. TI is not responsible or liable for any such statements.

TI products are not authorized for use in safety-critical applications (such as life support) where a failure of the TI product would reasonably be expected to cause severe personal injury or death, unless officers of the parties have executed an agreement specifically governing such use. Buyers represent that they have all necessary expertise in the safety and regulatory ramifications of their applications, and acknowledge and agree that they are solely responsible for all legal, regulatory and safety-related requirements concerning their products and any use of TI products in such safety-critical applications, notwithstanding any applications-related information or support that may be provided by TI. Further, Buyers must fully indemnify TI and its representatives against any damages arising out of the use of TI products in such safety-critical applications.

TI products are neither designed nor intended for use in military/aerospace applications or environments unless the TI products are specifically designated by TI as military-grade or "enhanced plastic." Only products designated by TI as military-grade meet military specifications. Buyers acknowledge and agree that any such use of TI products which TI has not designated as military-grade is solely at the Buyer's risk, and that they are solely responsible for compliance with all legal and regulatory requirements in connection with such use.

TI products are neither designed nor intended for use in automotive applications or environments unless the specific TI products are designated by TI as compliant with ISO/TS 16949 requirements. Buyers acknowledge and agree that, if they use any non-designated products in automotive applications, TI will not be responsible for any failure to meet such requirements.

Following are URLs where you can obtain information on other Texas Instruments products and application solutions:

Products		Applications	
Amplifiers	amplifier.ti.com	Audio	www.ti.com/audio
Data Converters	dataconverter.ti.com	Automotive	www.ti.com/automotive
DLP® Products	www.dlp.com	Communications and Telecom	www.ti.com/communications
DSP	dsp.ti.com	Computers and Peripherals	www.ti.com/computers
Clocks and Timers	www.ti.com/clocks	Consumer Electronics	www.ti.com/consumer-apps
Interface	interface.ti.com	Energy	www.ti.com/energy
Logic	logic.ti.com	Industrial	www.ti.com/industrial
Power Mgmt	power.ti.com	Medical	www.ti.com/medical
Microcontrollers	microcontroller.ti.com	Security	www.ti.com/security
RFID	www.ti-rfid.com	Space, Avionics & Defense	www.ti.com/space-avionics-defense
RF/IF and ZigBee® Solutions	www.ti.com/lprf	Video and Imaging	www.ti.com/video
		Wireless	www.ti.com/wireless-apps