

HRS SR38 SERIES CONNECTORS

MICROMINIATURE HIGH-PERFORMANCE MODEL SR38 CIRCULAR CONNECTORS

■ General

Developed to meet the requirements of the miniature and high-density electronic equipment, the Model SR38 is a microminiature circular interface connector.

With contact surfaces on both the plug and the receptacle, the SR38 is fully shielded and utilizes a simple locking mechanism.

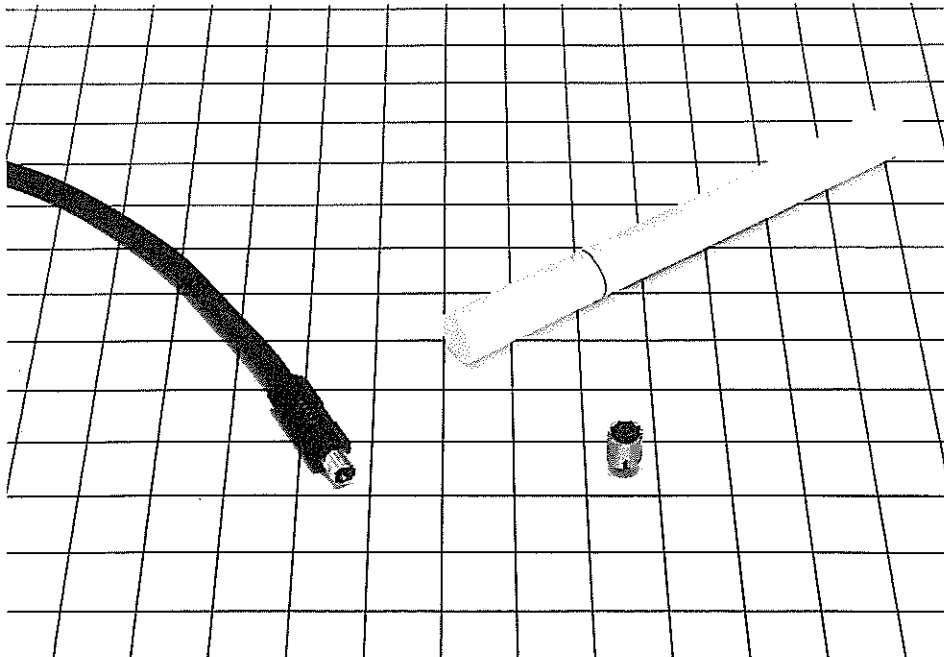

■ Features

1. Microminiature and high density
Allows space-saving packaging with the $\phi 5.3$ mm standard dia. (excluding protrusions) body.
Highly reliable against external force such as vibration due to the simple locking mechanism guards.
2. Easy to wire and mount
Plugs: Fold-up type, requiring no special tool.
Receptacles: Circuit board dip type

■ Applications

Video equipment, acoustic equipment, measuring instruments, and other electronic equipment.

■ Main materials

Part	Material	Finish
Outer case	Polypropylene resin (UL94V-0)	-
	Brass	Tin-plated (plug), Nickel-plated (receptacle)
Insulator	PBT resin (UV94V-0)	-
Male terminal	Phosphor bronze	Silver-plated
Female terminal	Phosphor bronze	Silver-plated

■ Product identification

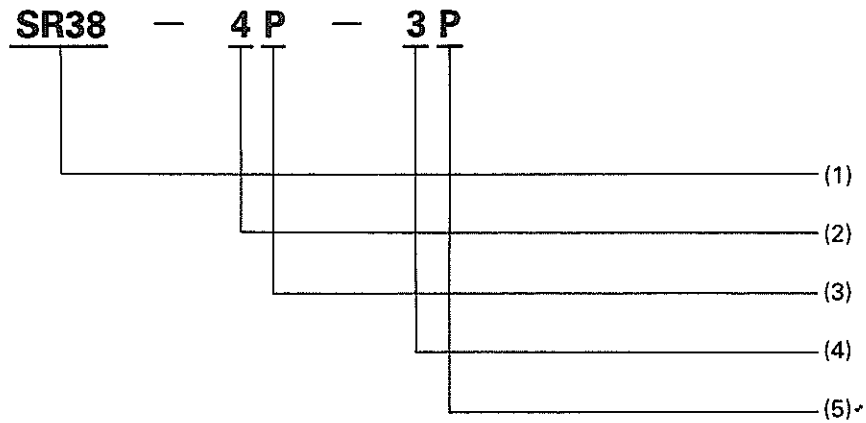

- (1) SR38 : Series name
- (2) 4 : Shell size, outside dia. of the mating part.
- (3) P : Forms of connectors
 P: Plug
 R: Receptacle
- (4) 3 : Number of terminals
- (5) P : Shape of terminals
 P: Male terminal
 S: Female terminal

■ Plug

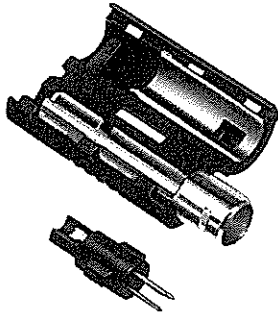

SR38-4P-3P (71)

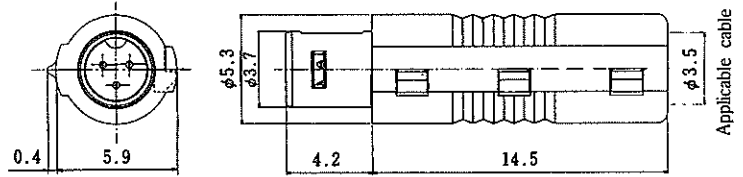

HRS No.	Product No.	RoHS
103-0372-2-71	SR38-4P-3P (71)	○

The SR38 has a clamping force of 1 to 2 kgf for the applicable cable. However, the clamping force varies depending on the cable. Check cables for clamping force before using them.

In particular, if cables are bent, check the cables to be used.

■ Receptacle

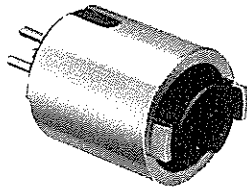

SR38-4R-3S (71)

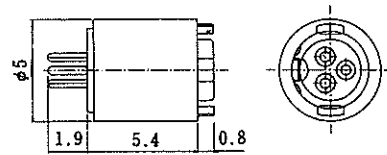

HRS No.	Product No.	RoHS
103-0373-5-71	SR38-4R-3S (71)	○

◆ Dip post arrangement and panel cutout

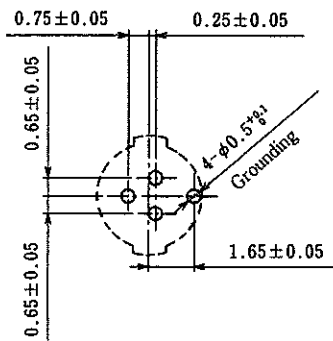

Dip post arrangement

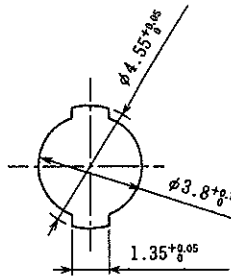

Panel cutout

◆ Mounting receptacles

Fix receptacles between a printed board and panel as shown below.

Use care that no stress is applied to the PCB pins.

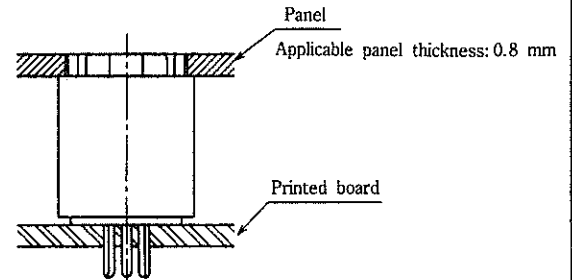

◆ Assembly procedure

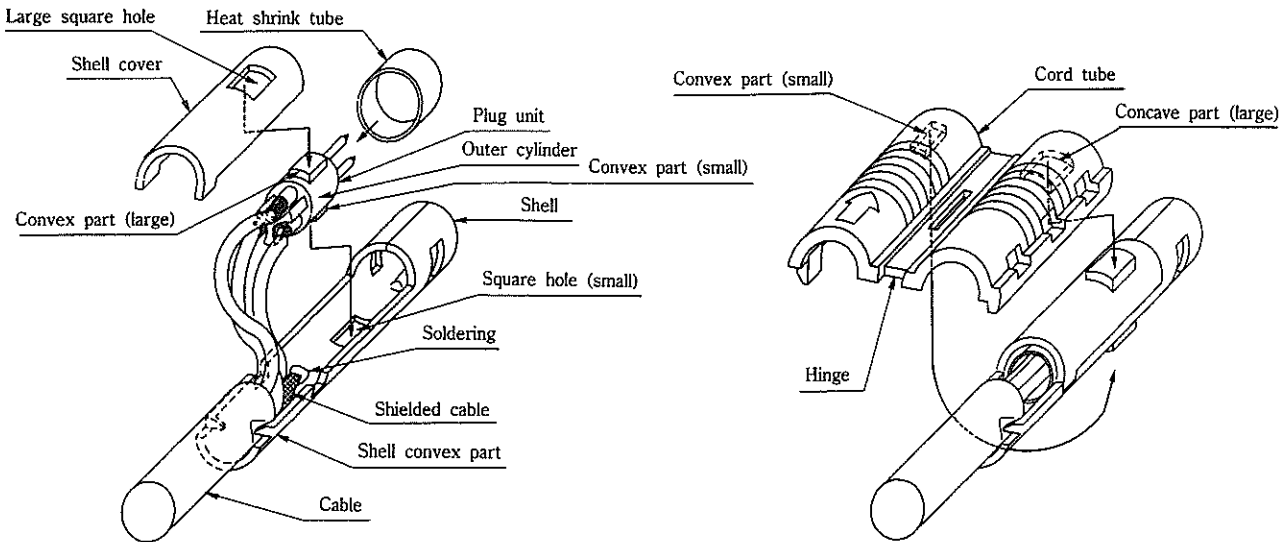

1. Solder an end-treated cable to the plug unit with a 280°C or less iron within 3 seconds.
2. Apply the accompanying heat shrink tube to the terminal, and heat-shrink it so that it does not cover the outer cylinder of the plug unit.
3. Solder the shielding wires to the bottom of the shell as shown in the above Fig.
4. Fit the cable sheath to the shell convex part.
5. Mount the plug unit with the convex part fitted to the shell, and mount the other shell cover.
6. Mate the cord tube with the assembled shell, and close the tube on the hinge.

■ Terminal arrangement and main functions

Terminal arrangement	
Item	Specification
Rated current	0.5 A
Contact resistance	30 mΩ or less
Insulation resistance	100 MΩ or more at 100 VDC
Withstand voltage	100 VAC for 1 min
Rated voltage	30 VAC, 42 VDC
Solder pot inside diam.	φ0.5

1. The Fig. shows the receptacle as viewed from its mating face side (plug wiring side).
2. Withstanding voltage is the actual testing voltage.
3. Rated current is the capacity per terminal.
4. Contact resistance is the measured value at 1 ADC.