

Part Number
10104109-0001LF

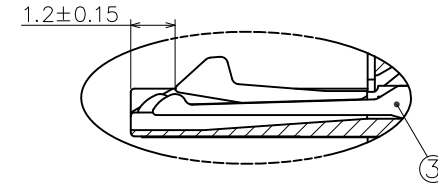

Plug Contact -A Point -2EA (No.2, No.4)
Plug Contact -B Point -1EA (No.3)

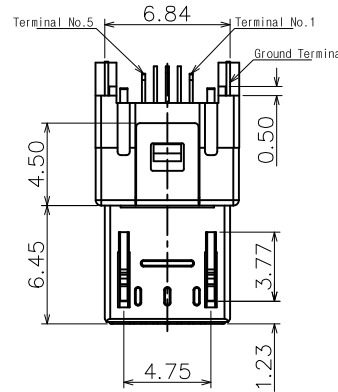
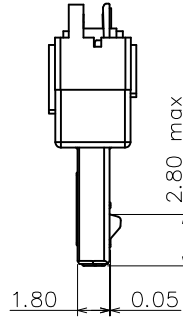
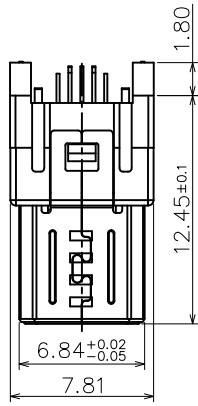
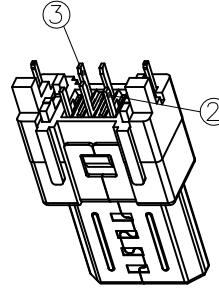
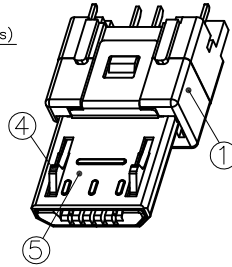
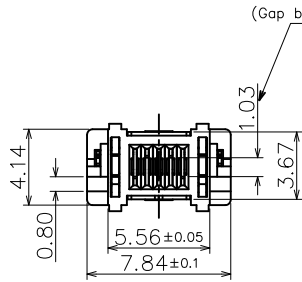
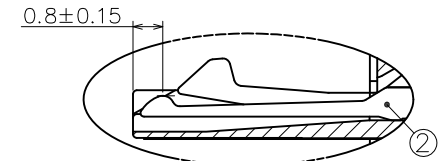

Plug Contact -B Point -2EA (No.1, No.5)

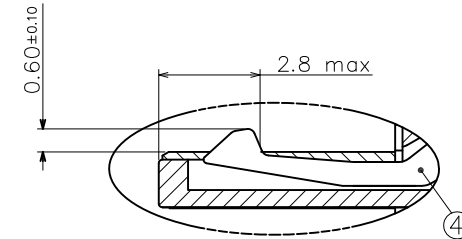

Plug Contact -LOCK TML' Point -2EA

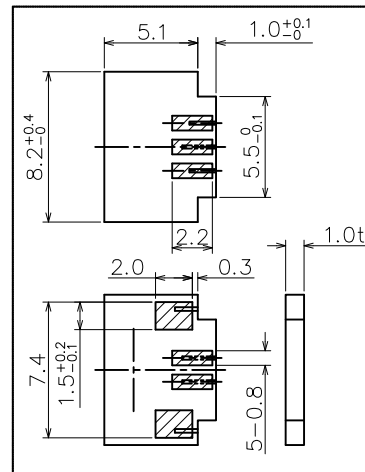
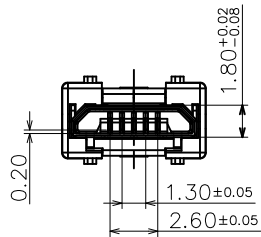

*PCB ref.
(Tolerance ±0.05)

- Note-
1. Material & finish: See table-1
 2. Packing in tray

(Table-1)

No.	Part Name	Material	Finish	Remarks
1	Plug Housing	Thermoplastic	black	
2	Plug Contact -B	Copper alloy	Selective Gold Plated	
3	Plug Contact -A	Copper alloy	Selective Gold Plated	
4	Lock Plate	Sustainess steel		
5	Plug Shield	Sustainess steel	Ni Plated	

mat'l. code				tolerances unless otherwise specified		CUSTOMER COPY		 www.fciconnect.com		
ltr	ecn no	dr	date	linear	.X ± 0.38	projection		title		
A	T10-0002	J.H	01/07/10		.XX ± 0.25			MICRO-USB B-TYPE PLUG		
					.XXX ± 0.10					
				angles	0° ± 2°					
				dr	JASON HSU 01/07/10	 MM	 scale	product family	USB	code
				enr	JASON HSU 01/07/10			size	dwg no	TWN
				chr	GARY HSIEH 01/07/10			A4	10104109	sheet
				appd	JOSEPH HSIA 01/07/10			1:1		1 of 1
sheet index	revision sheet	A	1					cage code		