

No. OF PINS	DIMENSIONS						
	A	B	C	D	E	F	G
9	1.213	0.984	0.669	0.331	0.760	0.480	0.429
	30.80	24.99	17.00	8.40	19.20	12.60	10.90
15	1.541	1.312	0.996	0.331	1.083	0.480	0.429
	39.15	33.32	25.30	8.40	27.51	12.60	10.90
25	2.088	1.852	1.535	0.331	1.630	0.480	0.429
	53.04	47.04	39.00	8.40	41.40	12.60	10.90
37	2.729	2.500	2.181	0.331	2.276	0.480	0.429
	69.32	63.50	55.40	8.40	57.81	12.60	10.90
50	2.635	2.406	2.079	0.437	2.182	0.598	0.535
	66.93	61.11	52.80	11.10	55.42	15.20	13.60

172-YYY-112RYY1

- SERIES _____
- POSITIONS _____
- 009 _____
- 015 _____
- 025 _____
- 037 _____
- 050 _____
- GENDER _____
- 1 = MALE
- TERMINATION _____
- 1 = DIP SOLDER
- SHELL PLATING _____
- 2 = TIN (GROUND INDENTS)
- RoHS COMPLIANT _____
- HARDWARE OPTIONS _____
- 00 = NO HARDWARE
- 01 = .065" CLINCH NUT (BOARD SIDE)
- 02 = .250" CLINCH NUT (BOARD SIDE)
- 03 = .250" CLINCH NUT (MOUNTING SIDE)
- 05 = .237" 4-40 BOARD LOCK
- 91 = .237" 4-40 SPACER/ BOARD LOCK
- PLATING OPTIONS _____
- 1 = GOLD FLASH
- 2 = 30MICRO-INCH GOLD

MATERIAL:

SHELL: STEEL, TIN
 INSULATOR: UL 94V-O RATED, BEIGE PBTP
 PROCESS TEMP.: 260° C
 CONTACT: BRASS

ELECTRICAL:

CURRENT RATING: 5 AMPS
 CONTACT RESISTANCE: 15 mOhms Max.
 INSULATION RESISTANCE: 1,000 MOhms min.
 VOLTAGE: 500VAC FOR 1 MINUTE
 TEMPERATURE: -50° C TO 100° C

DO NOT SCALE FROM DRAWING

RoHS COMPLIANT

	THESE DRAWINGS AND SPECIFICATIONS ARE THE PROPERTY OF NorComp AND SHALL NOT BE REPRODUCED, COPIED OR USED AS THE BASIS FOR THE MANUFACTURE OF SALE OF APPARATUS WITHOUT WRITTEN PERMISSION.		DRAWN: PAM JENKINS	DATE: 09-12-05
			CHECKED:	DATE:
NorComp		SCALE: 1 : 1	SHEET 1 OF 3	REV 9
		DWG NO. 172-YYY-112RYY1		

DESCRIPTION: PCB LAYOUT - STANDARD "D" - MALE & FEMALE

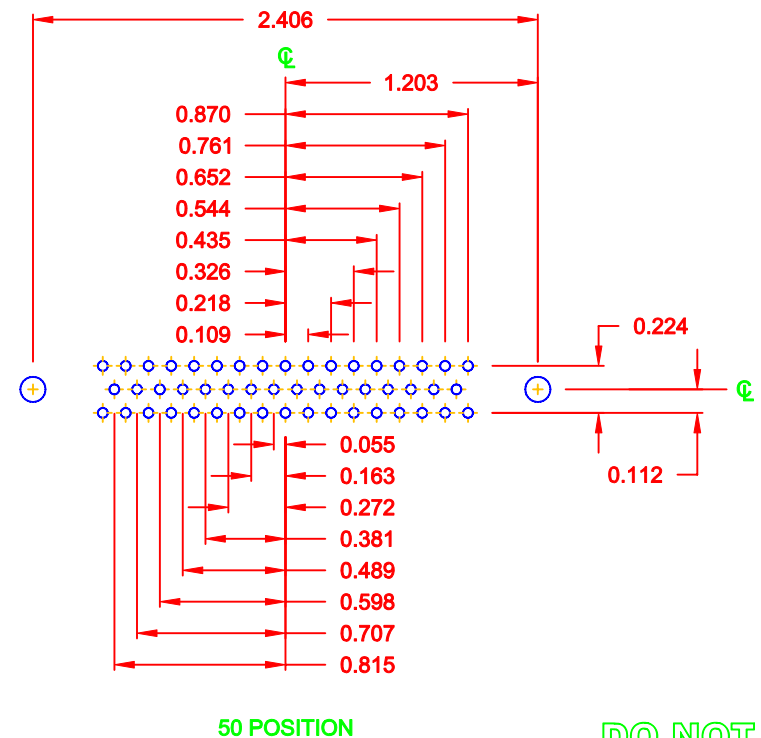
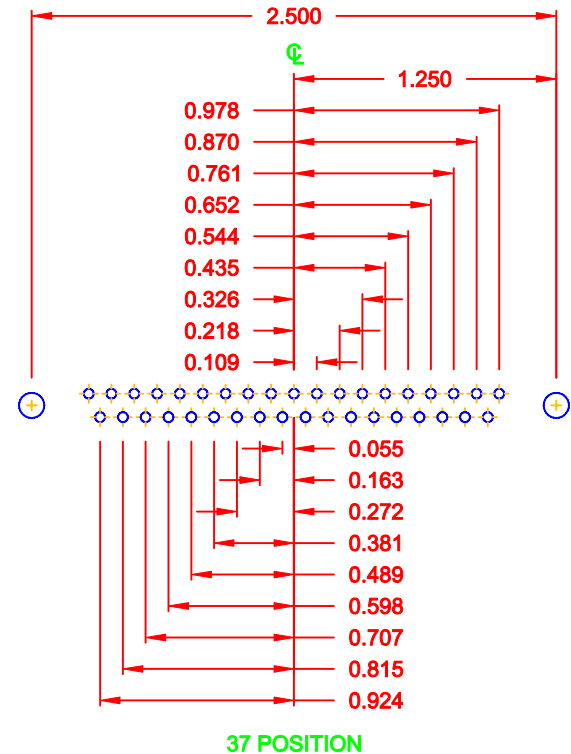
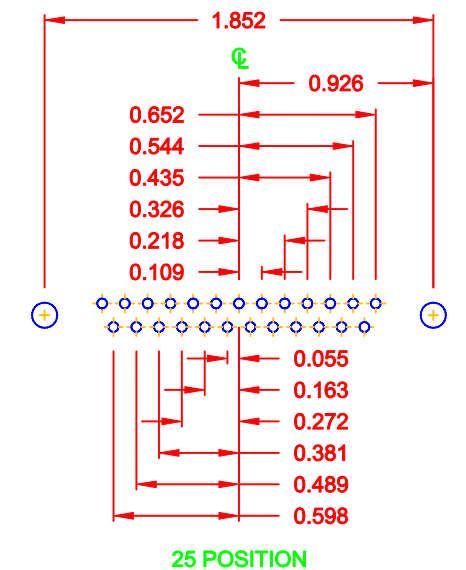
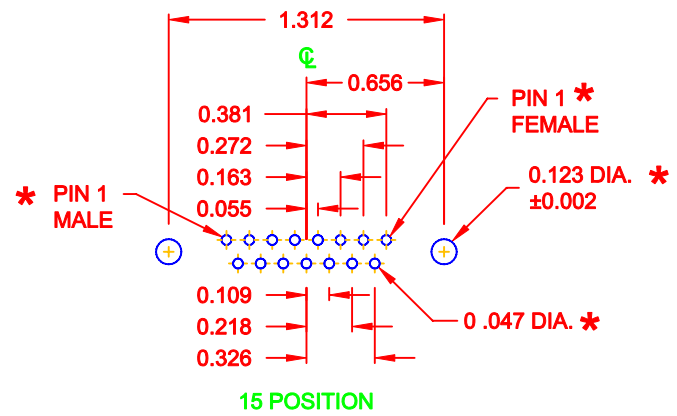
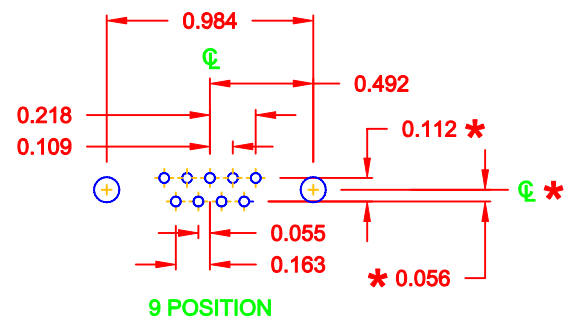

* TYP. ON ALL SIZES

DO NOT SCALE FROM DRAWING

	THESE DRAWINGS AND SPECIFICATIONS ARE THE PROPERTY OF NorComp AND SHALL NOT BE REPRODUCED, COPIED OR USED AS THE BASIS FOR THE MANUFACTURE OF SALE OF APPARATUS WITHOUT WRITTEN PERMISSION.		DRAWN: C. SMITH	DATE: 03-08-06
			CHECKED:	DATE:
NorComp	SCALE: FULL	SHEET 2 OF 3	REV 9	
	DWG NO. 172-YYY-112RYY1			

ALL CLINCH-NUTS ARE 4-40 INTERNAL THREADS

01X 0.065" (BOARD SIDE) - CN1

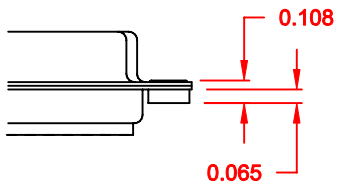

05X 0.237" (BOARD SIDE) - CN10

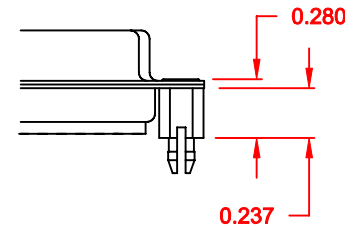

02X 0.250" (BOARD SIDE) - CN2

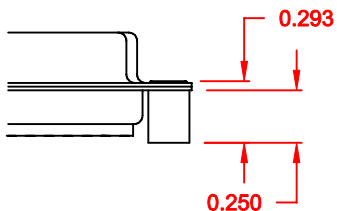

91X 0.237" (BOARD SIDE) - 0.197 MATING SIDE - CN10/SFSO4404

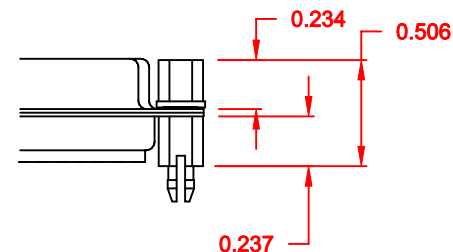

03X..... 0.250" (MATING SIDE) - CN8

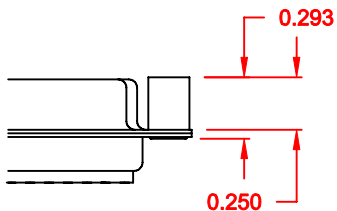

NOTE: 4-40 FEMALE SCREW LOCK IS REMOVABLE

DO NOT SCALE FROM DRAWING

RoHS COMPLIANT

	THESE DRAWINGS AND SPECIFICATIONS ARE THE PROPERTY OF NorComp AND SHALL NOT BE REPRODUCED, COPIED OR USED AS THE BASIS FOR THE MANUFACTURE OF SALE OF APPARATUS WITHOUT WRITTEN PERMISSION.		DRAWN: WAYNE ROBBINS	DATE: 11-28-05
			CHECKED:	DATE:
NorComp		SCALE:	SHEET 3 OF 3	REV 9
		DWG NO. 172-YYY-112RYY1		