

4

3

2

1

THIS DRAWING IS UNPUBLISHED. RELEASED FOR PUBLICATION 2009  
 © COPYRIGHT 2009 BY TYCO ELECTRONICS CORPORATION. ALL RIGHTS RESERVED.

LOC		DIST		REVISIONS				
P	LTR	DESCRIPTION			DATE	DWN	APVD	
	BA	NEW RELEASE			16 JUNE 2010	PT	ST.P	

FOR FURTHER INFORMATION SEE DATA SHEET FOR  
 SERIES HOLCO. AXIAL LEADED PRECISION RESISTORS

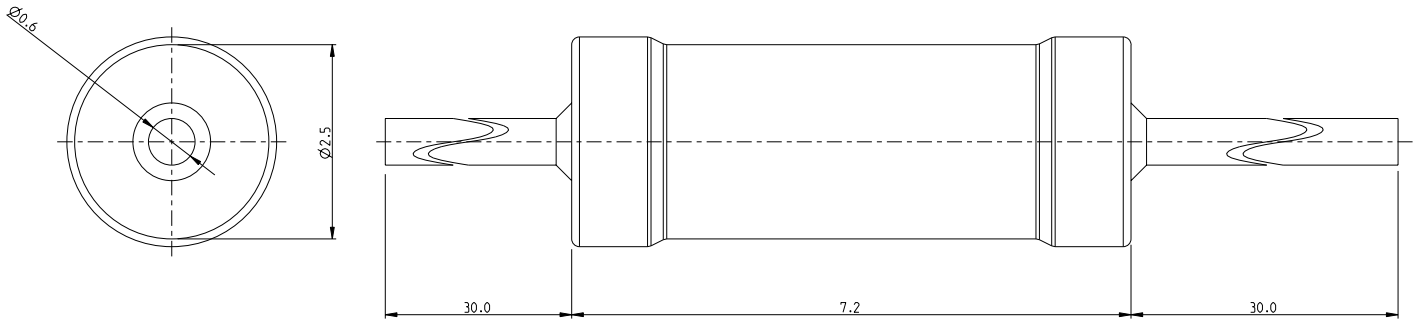

RoHS Compliant

<small>THIS DRAWING IS A CONTROLLED DOCUMENT FOR TYCO ELECTRONICS CORPORATION          IT IS SUBJECT TO CHANGE AND THE CONTROLLING ENGINEERING ORGANIZATION          SHOULD BE CONTACTED FOR THE LATEST REVISION.</small>		DWN PARUSURAM.T 16 JUNE 2010 CHK ALLAN.P 16 JUNE 2010 APVD STEPHEN.P 16 JUNE 2010	Tyco Electronics Corporation Dorcan, Swindon, SN3 5HH
DIMENSIONS: mm	TOLERANCES UNLESS OTHERWISE SPECIFIED: 0 PLC ± 0.2 1 PLC ± 0.1 2 PLC ± - 3 PLC ± - 4 PLC ± - ANGLES ± 5°	NAME AXIAL LEADED PRECISION RESISTORS SERIES HOLCO H8	RESTRICTED TO -
MATERIAL -	FINISH -	SIZE A3 CAGE CODE 00779 DRAWING NO C-1879644	SCALE 20:1 SHEET 1 OF 1 REV BA
CUSTOMER DRAWING			

AMP 1470-19 REV 31MAR2000

Pro/ENGINEER DRAWING