

PTSA 0,5/ 3-2,5-Z

Order No.: 1990012

The figure shows a 10-position version of the product

<http://eshop.phoenixcontact.de/phoenix/treeViewClick.do?UID=1990012>Pcb terminal, number of poles: 3, pitch: 2.5 mm, U = 160 V, I = 2 A,
cross section: 0.5 mm²

Commercial data

EAN	4017918973582
Pack	250 Pcs.
Customs tariff	85369010
Weight/Piece	0.00134 KG
Catalog page information	Page 407 (CC-2007)

Product notes

WEEE/RoHS-compliant since:
01/29/2004

<http://www.download.phoenixcontact.com>
Please note that the data given here has been taken from the online catalog. For comprehensive information and data, please refer to the user documentation. The General Terms and Conditions of Use apply to Internet downloads.

Technical data

Dimensions / positions

Pitch	2.5 mm
Number of positions	3
Pin dimensions	0,4 x 0,75
Pin spacing	2.5 mm

Technical data

Rated surge voltage (III/3)	2.5 kV
Rated surge voltage (III/2)	2.5 kV
Rated surge voltage (II/2)	2.5 kV
Rated voltage (III/2)	250 V
Rated voltage (II/2)	250 V
Connection in acc. with standard	EN-VDE
Nominal current I_N	2 A
Nominal voltage U_N	160 V
Nominal cross section	0.5 mm ²
Maximum load current	2 A
Stripping length	8 mm

Connection data

Conductor cross section solid min.	0.14 mm ²
Conductor cross section solid max.	0.5 mm ²
Conductor cross section stranded min.	0.2 mm ²
Conductor cross section stranded max.	0.5 mm ²
Conductor cross section AWG/kcmil min.	24
Conductor cross section AWG/kcmil max	20

Certificates / Approvals

Approval logo



CUL

Nominal voltage U_N	300 V
Nominal current I_N	2 A
AWG/kcmil	26-20

UL

Nominal voltage U_N	300 V
Nominal current I_N	2 A
AWG/kcmil	26-20

Certification

CCA, CUL, UL, VDE-PZI

Drawings

Drilling diagram

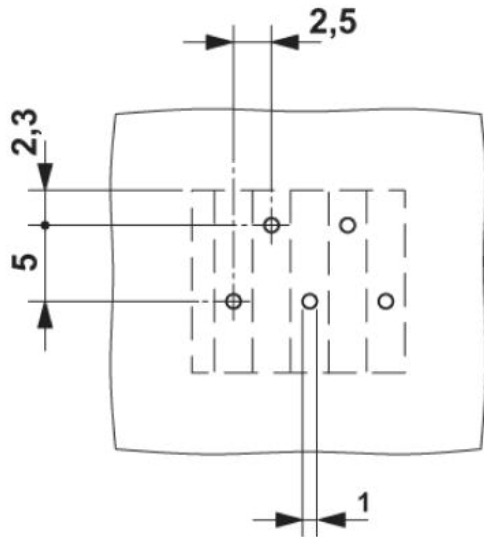

The illustration shows the 5-pos. version – Zig-zag pinning starts at the right-hand position. Other pinning available on request.

Dimensioned drawing

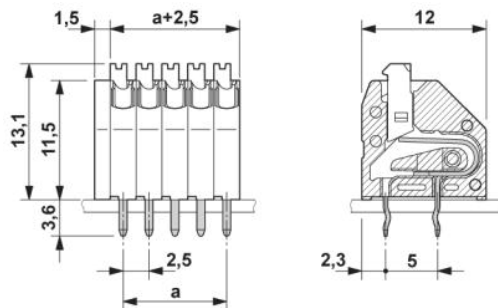

The illustration shows the 5-pos. version