

THIS DRAWING IS UNPUBLISHED. RELEASED FOR PUBLICATION 20
 © COPYRIGHT 20 BY TYCO ELECTRONICS CORPORATION. ALL RIGHTS RESERVED.

LOC	DIST	REVISIONS					
FT	0	P	LTR	DESCRIPTION	DATE	DWN	APVD
		E10		REVISED PER ECO-08-024457	03OCT2008	HMR	CR

- 1 MATERIALS AND FINISH
 HOUSING: PA 6-6, UL 94-V0, COLOR: GREEN.
 CLAMP: BRASS, NICKEL PLATED.
 CONTACT SPRING : PHOSPHOR BRONZE, TIN PLATED.
 CLAMPING SCREW: M3, BRASS, NICKEL PLATED.
- 2. WIRE SIZE RANGE: 12 - 30 AWG
- 3 NOT CUMULATIVE TOLERANCE.
- 4 CHARACTERS MARKED IN PERMANENT WHITE COLOR.
- 5 PARTS SHOWN WITH INTEGRATED KEYING FEATURE LOCATED AS SHOWN.
- 6 CHARACTERS MARKED IN PERMANENT BLACK COLOR.

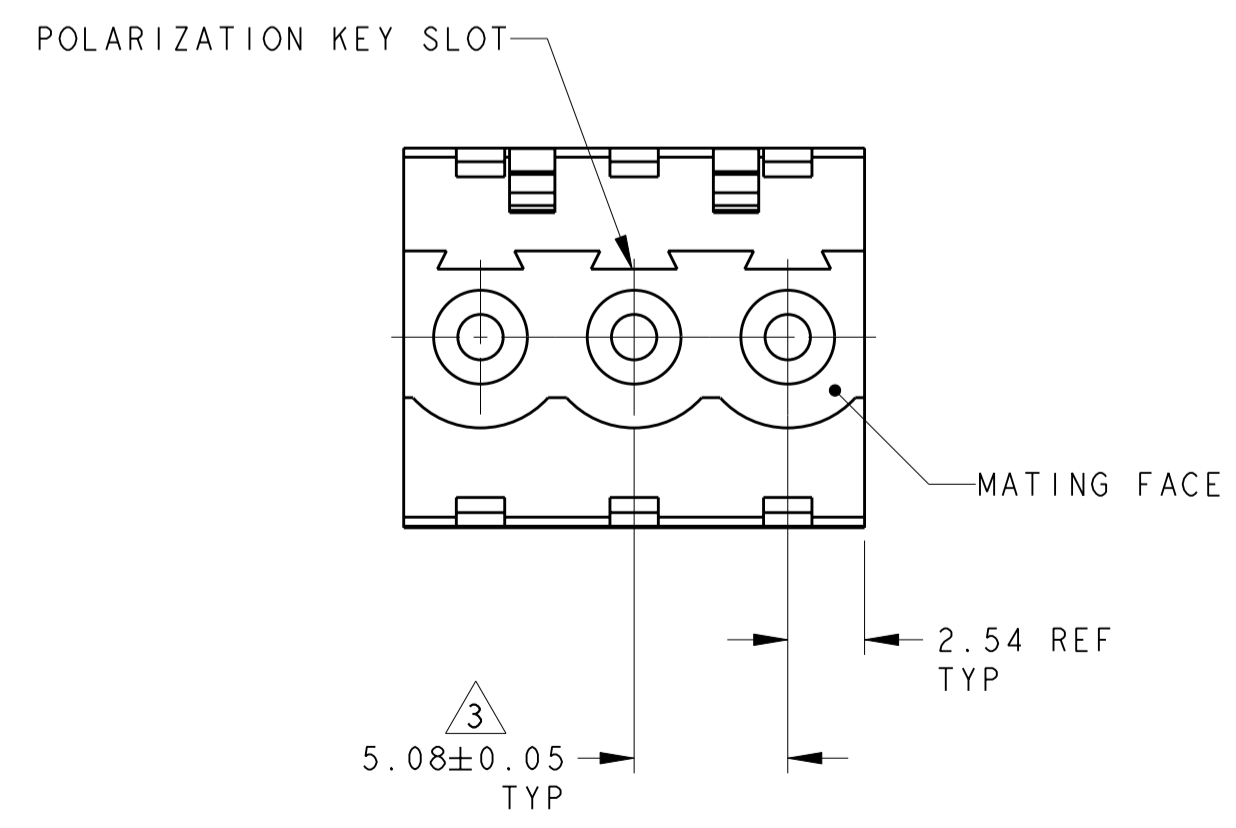
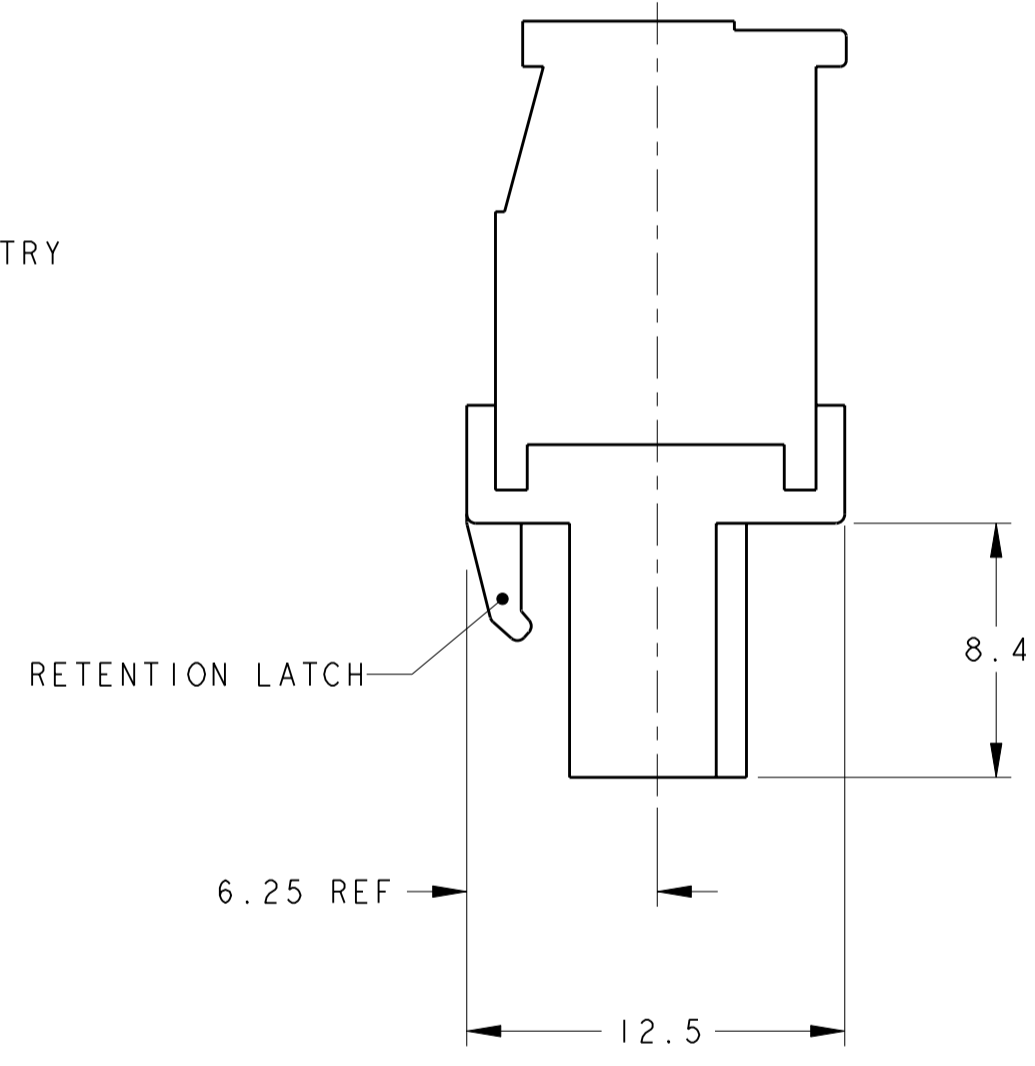
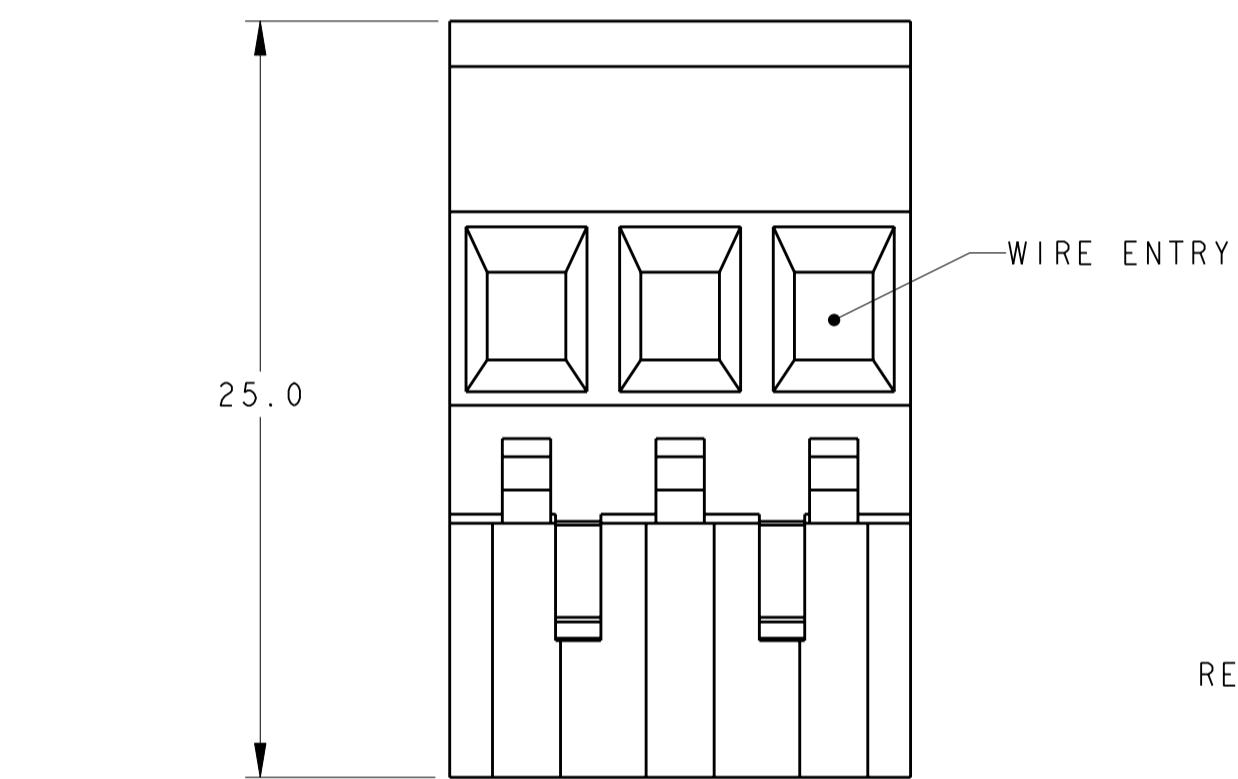
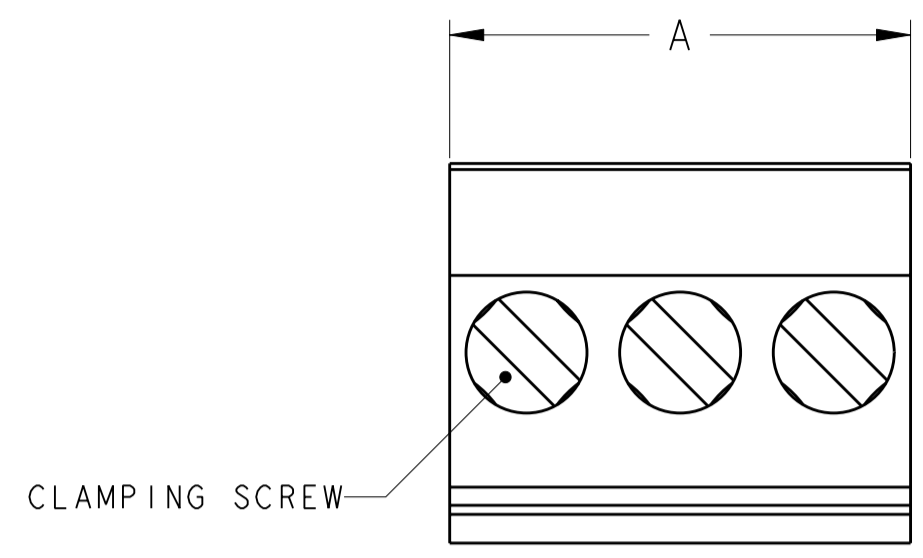

SEE DETAIL A-D	106.68	21	4-284047-1
SEE DETAIL A-C	106.68	21	4-284047-0
SEE DETAIL A-B	76.20	15	3-284047-9
SEE DETAIL A-A	76.20	15	3-284047-8
SEE DETAIL Z	121.92	24	3-284047-7
5 SEE DETAIL X	81.28	16	3-284047-6
5 SEE DETAIL W	81.28	16	3-284047-5
5 SEE DETAIL V	60.96	12	3-284047-4
5 SEE DETAIL U	60.96	12	3-284047-3
5 SEE DETAIL T	121.92	24	3-284047-2
5 SEE DETAIL S	121.92	24	3-284047-1
5 SEE DETAIL R	91.44	18	3-284047-0
5 SEE DETAIL P	91.44	18	2-284047-9
SEE DETAIL N	24.40	5	2-284047-8
SEE DETAIL M	20.32	4	2-284047-7
SEE DETAIL L	10.16	2	2-284047-6
-	127.00	25	2-284047-5
-	121.92	24	2-284047-4
-	116.84	23	2-284047-3
-	111.76	22	2-284047-2
-	106.68	21	2-284047-1
-	101.60	20	2-284047-0
-	96.52	19	1-284047-9
-	91.44	18	1-284047-8
-	86.36	17	1-284047-7
-	81.28	16	1-284047-6
-	76.20	15	1-284047-5
-	71.12	14	1-284047-4
-	66.04	13	1-284047-3
-	60.96	12	1-284047-2
-	55.88	11	1-284047-1
-	50.80	10	1-284047-0
-	45.72	9	284047-9
-	40.64	8	284047-8
-	35.56	7	284047-7
-	30.48	6	284047-6
-	24.40	5	284047-5
-	20.32	4	284047-4
-	15.24	3	284047-3
-	10.16	2	284047-2
MARKING	A	NO OF POSN	PART NUMBER

THIS DRAWING IS A CONTROLLED DOCUMENT FOR TYCO ELECTRONICS CORPORATION IT IS SUBJECT TO CHANGE AND THE CONTROLLING ENGINEERING ORGANIZATION SHOULD BE CONTACTED FOR THE LATEST REVISION.		DWN S.WELDON 05FEB2003 CHK C.RICHARD 05FEB2003 APVD C.RICHARD 05FEB2003	Tyco Electronics Harrisburg, PA 17105-3608
DIMENSIONS: mm 	TOLERANCES UNLESS OTHERWISE SPECIFIED: 0 PLC ±.3 1 PLC ±.25 2 PLC ±.25 3 PLC ±. 4 PLC ±. ANGLES ±2 FINISH	PRODUCT SPEC APPLICATION SPEC WEIGHT	NAME TERMINAL BLOCK, VERTICAL PLUG, STACKING, RIGHT HAND, 5.08mm PITCH
MATERIAL			SIZE A200779 CAGE CODE C-284047 DRAWING NO 284047 RESTRICTED TO
CUSTOMER DRAWING		SCALE 1:1	SHEET 1 OF 8 REV E10

THIS DRAWING IS UNPUBLISHED. RELEASED FOR PUBLICATION 20
 © COPYRIGHT 20 BY TYCO ELECTRONICS CORPORATION. ALL RIGHTS RESERVED.

LOC	DIST	REVISIONS			
P	LTR	DESCRIPTION	DATE	DWN	APVD
FT	0	-	SEE SHEET 1	-	-

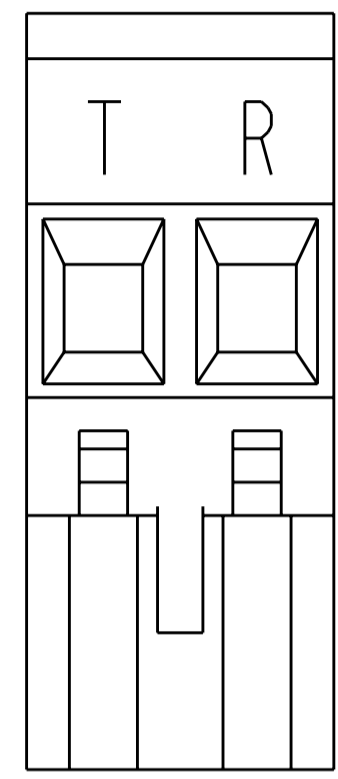

SEE DETAIL L
 4

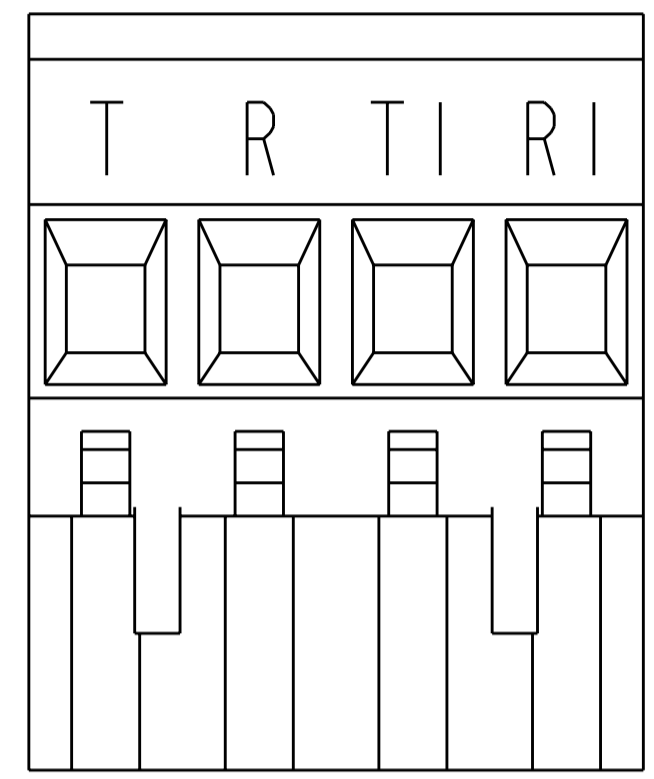

SEE DETAIL M
 4

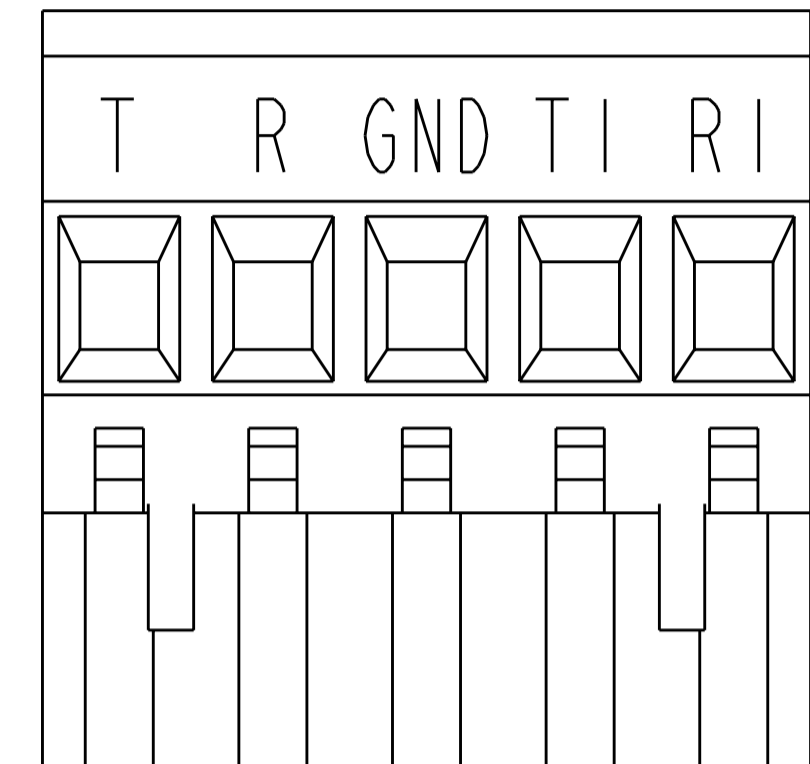

SEE DETAIL N
 4

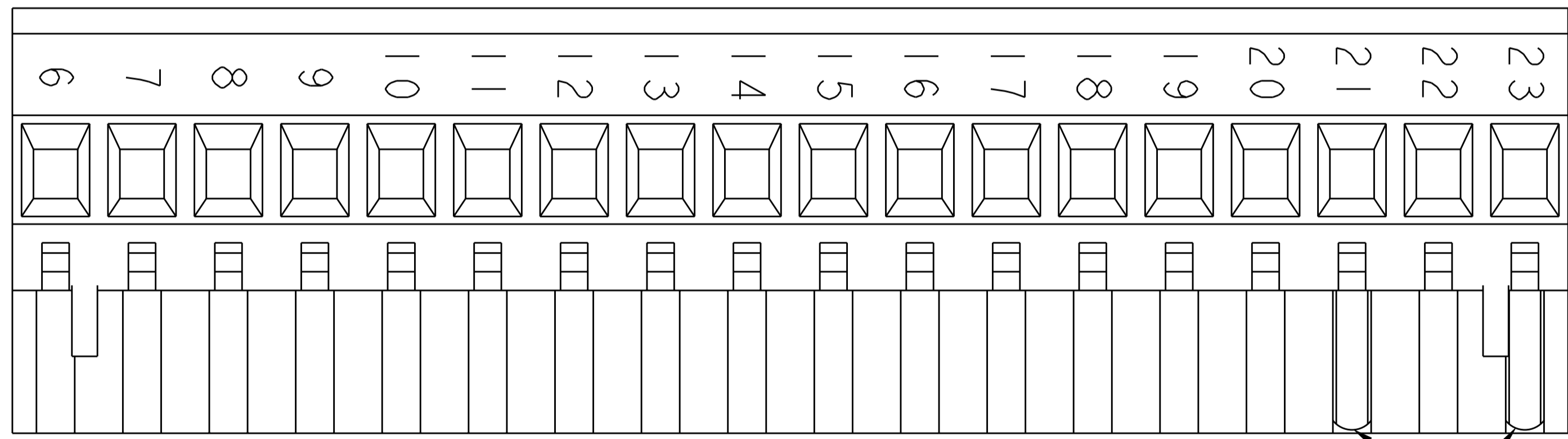

SEE DETAIL P
 6

<small>THIS DRAWING IS A CONTROLLED DOCUMENT FOR TYCO ELECTRONICS CORPORATION. IT IS SUBJECT TO CHANGE AND THE CONTROLLING ENGINEERING ORGANIZATION SHOULD BE CONTACTED FOR THE LATEST REVISION.</small>		DWN S. WELDON 05FEB2003 CHK C. RICHARD 05FEB2003 APVD C. RICHARD 05FEB2003	Tyco Electronics Tyco Electronics Harrisburg, PA 17105-3608
DIMENSIONS: mm 		TOLERANCES UNLESS OTHERWISE SPECIFIED: 0 PLC ±- 1 PLC ±.3 2 PLC ±.25 3 PLC ±- 4 PLC ±- ANGLES ±- FINISH ±2	NAME: TERMINAL BLOCK, VERTICAL PLUG, STACKING, RIGHT HAND, 5.08mm PITCH SIZE: A200779 CAGE CODE: C-284047 DRAWING NO: - RESTRICTED TO: -
MATERIAL: -		PRODUCT SPEC: - APPLICATION SPEC: - WEIGHT: -	SCALE: 1:1 SHEET 2 OF 8 REV: E10

THIS DRAWING IS UNPUBLISHED. RELEASED FOR PUBLICATION 20
 © COPYRIGHT 20 BY TYCO ELECTRONICS CORPORATION. ALL RIGHTS RESERVED.

LOC	DIST	REVISIONS			
P	LTR	DESCRIPTION	DATE	DWN	APVD
		SEE SHEET 1			

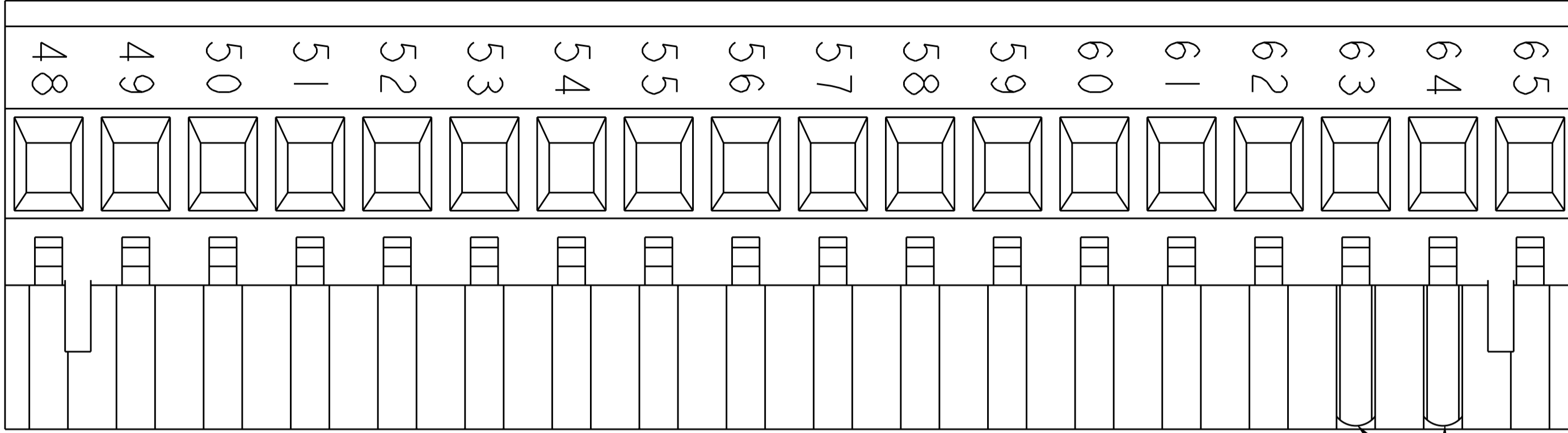

SEE DETAIL R
 ⚠

CODING KEY

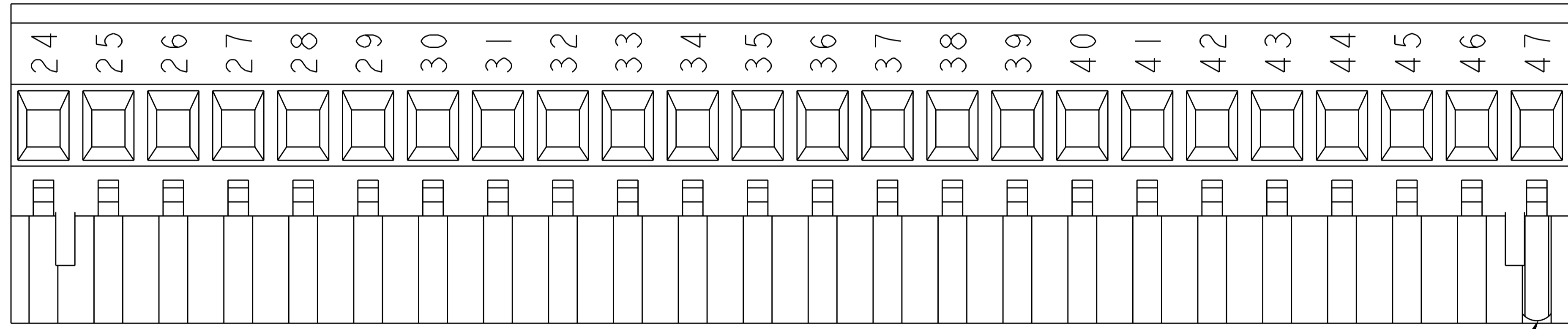

SEE DETAIL S
 ⚠

CODING KEY

<small>THIS DRAWING IS A CONTROLLED DOCUMENT FOR TYCO ELECTRONICS CORPORATION IT IS SUBJECT TO CHANGE AND THE CONTROLLING ENGINEERING ORGANIZATION SHOULD BE CONTACTED FOR THE LATEST REVISION.</small>		DWN S.WELDON 05FEB2003 CHK C.RICHARD 05FEB2003 APVD C.RICHARD 05FEB2003	Tyco Electronics Tyco Electronics Harrisburg, PA 17105-3608
DIMENSIONS: mm 	TOLERANCES UNLESS OTHERWISE SPECIFIED: 0 PLC ±- 1 PLC ±.3 2 PLC ±.25 3 PLC ±- 4 PLC ±- ANGLES ±2 FINISH	PRODUCT SPEC - APPLICATION SPEC - WEIGHT -	NAME TERMINAL BLOCK, VERTICAL PLUG, STACKING, RIGHT HAND, 5.08mm PITCH
MATERIAL		SIZE A200779 CAGE CODE C-284047 DRAWING NO. - RESTRICTED TO -	SCALE 1:1 SHEET 3 OF 8 REV E10
CUSTOMER DRAWING			

THIS DRAWING IS UNPUBLISHED. RELEASED FOR PUBLICATION 20
 © COPYRIGHT 20 BY TYCO ELECTRONICS CORPORATION. ALL RIGHTS RESERVED.

LOC	DIST	REVISIONS				
P	LTR	DESCRIPTION	DATE	DWN	APVD	
	FT	0	-	SEE SHEET 1	-	-

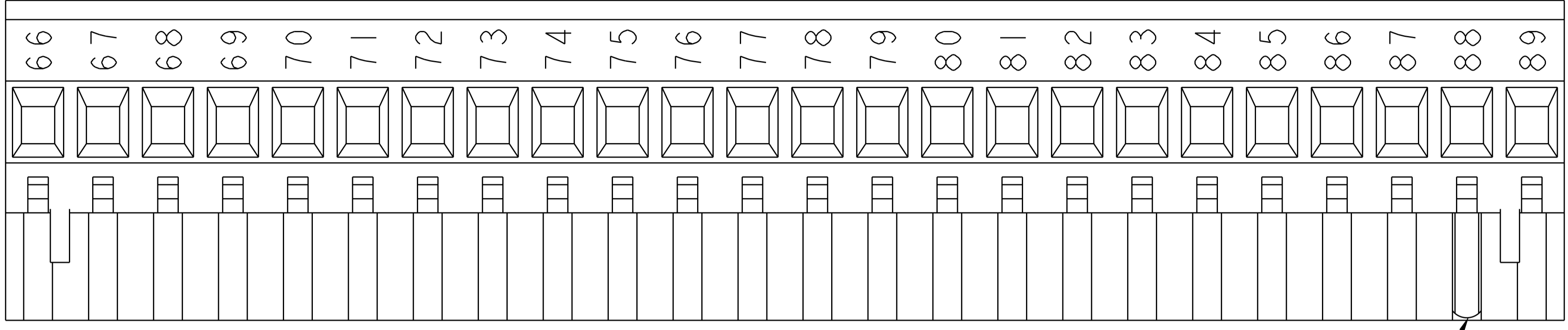

SEE DETAIL T
 △
 6

CODING KEY

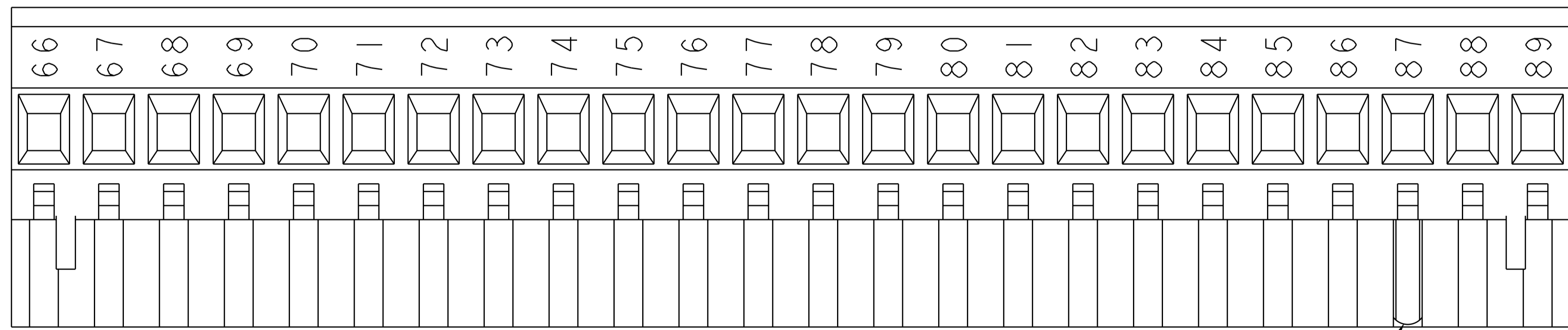

SEE DETAIL Z
 △
 6

CODING KEY

<small>THIS DRAWING IS A CONTROLLED DOCUMENT FOR TYCO ELECTRONICS CORPORATION IT IS SUBJECT TO CHANGE AND THE CONTROLLING ENGINEERING ORGANIZATION SHOULD BE CONTACTED FOR THE LATEST REVISION.</small>		DWN S. WELDON 05FEB2003 CHK C. RICHARD 05FEB2003 APVD C. RICHARD 05FEB2003	Tyco Electronics Tyco Electronics Harrisburg, PA 17105-3608
DIMENSIONS: mm 	TOLERANCES UNLESS OTHERWISE SPECIFIED: 0 PLC ±- 1 PLC ±.3 2 PLC ±.25 3 PLC ±- 4 PLC ±- ANGLES ±2 FINISH	PRODUCT SPEC - APPLICATION SPEC - WEIGHT -	NAME TERMINAL BLOCK, VERTICAL PLUG, STACKING, RIGHT HAND, 5.08mm PITCH
MATERIAL -		SIZE A200779 CAGE CODE C-284047 DRAWING NO. - RESTRICTED TO -	SCALE 1:1 SHEET 4 OF 8 REV E10
CUSTOMER DRAWING			

4

3

2

1

THIS DRAWING IS UNPUBLISHED. RELEASED FOR PUBLICATION 20
 © COPYRIGHT 20 BY TYCO ELECTRONICS CORPORATION. ALL RIGHTS RESERVED.

LOC	DIST	REVISIONS			
P	LTR	DESCRIPTION	DATE	DWN	APVD
FT	0	SEE SHEET 1	-	-	-

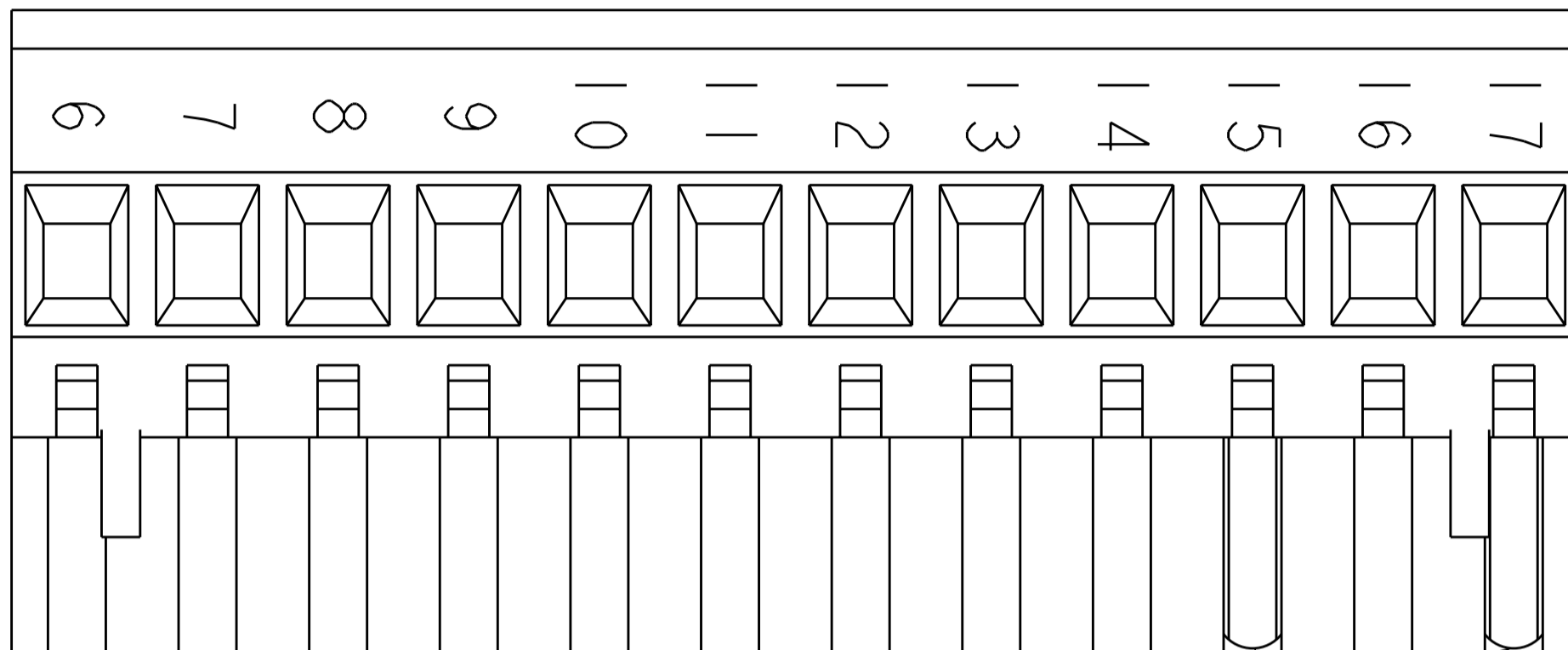

SEE DETAIL U



CODING KEY

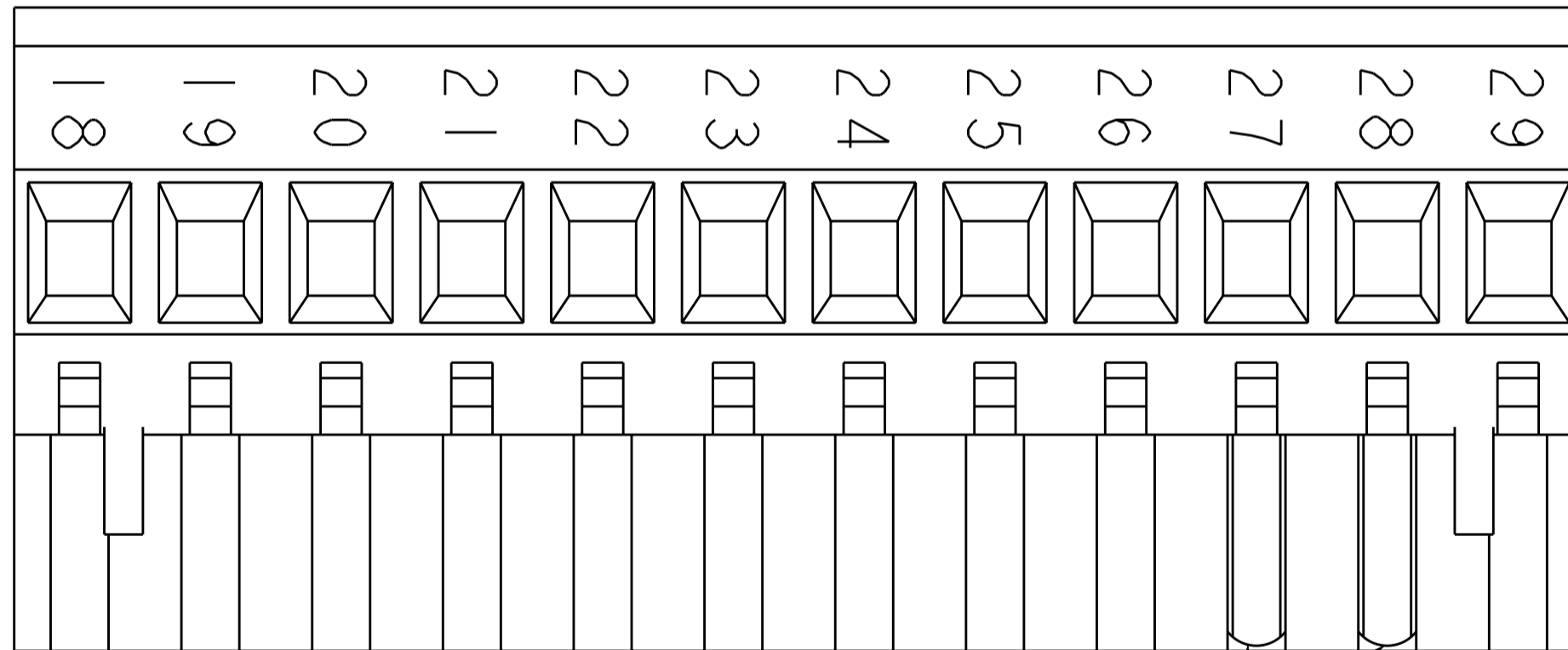

SEE DETAIL V



CODING KEY

<small>THIS DRAWING IS A CONTROLLED DOCUMENT FOR TYCO ELECTRONICS CORPORATION. IT IS SUBJECT TO CHANGE AND THE CONTROLLING ENGINEERING ORGANIZATION SHOULD BE CONTACTED FOR THE LATEST REVISION.</small>		DWN S. WELDON 05FEB2003 CHK C. RICHARD 05FEB2003 APVD C. RICHARD 05FEB2003	Tyco Electronics Harrisburg, PA 17105-3608
DIMENSIONS: mm		PRODUCT SPEC APPLICATION SPEC	NAME TERMINAL BLOCK, VERTICAL PLUG, STACKING, RIGHT HAND, 5.08mm PITCH
TOLERANCES UNLESS OTHERWISE SPECIFIED: 0 PLC ±- 1 PLC ±.3 2 PLC ±.25 3 PLC ±- 4 PLC ±- ANGLES ±2 FINISH		WEIGHT CUSTOMER DRAWING	SIZE A200779
MATERIAL -		DRAWING NO. C-284047	RESTRICTED TO -
AMP 1471-9 REV 31MAR2000		SCALE 1:1	SHEET 5 OF 8 REV E10

4

3

2

1

THIS DRAWING IS UNPUBLISHED. RELEASED FOR PUBLICATION 20
 © COPYRIGHT 20 BY TYCO ELECTRONICS CORPORATION. ALL RIGHTS RESERVED.

LOC	DIST	REVISIONS			
P	LTR	DESCRIPTION	DATE	DWN	APVD
-	-	SEE SHEET 1	-	-	-

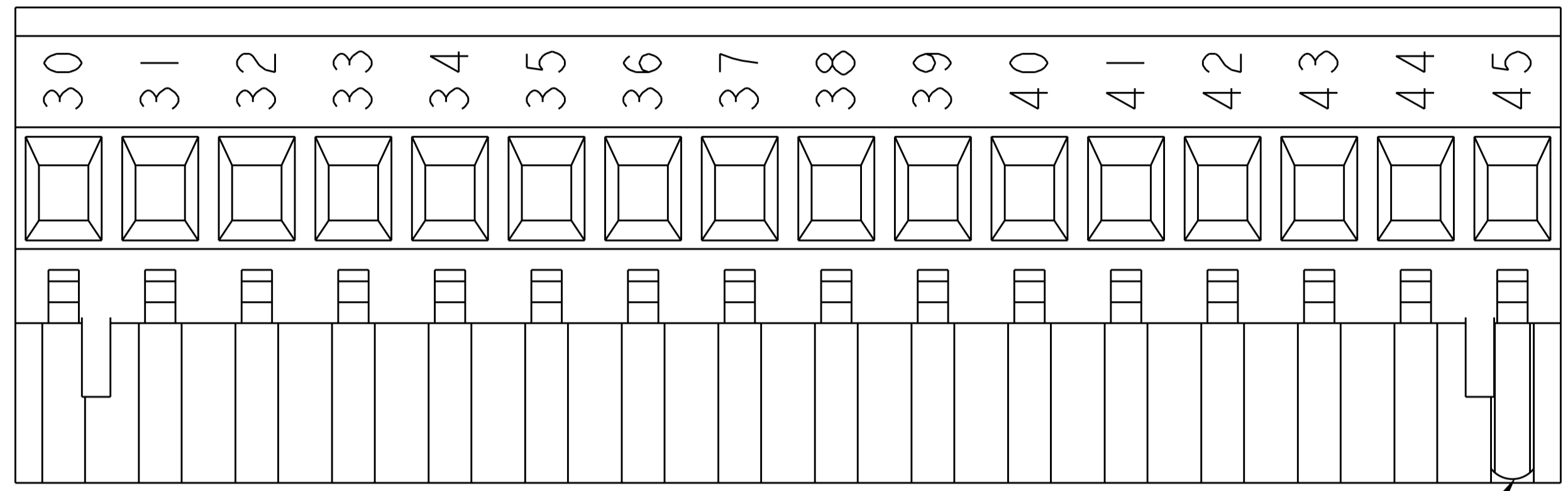

SEE DETAIL W



CODING KEY

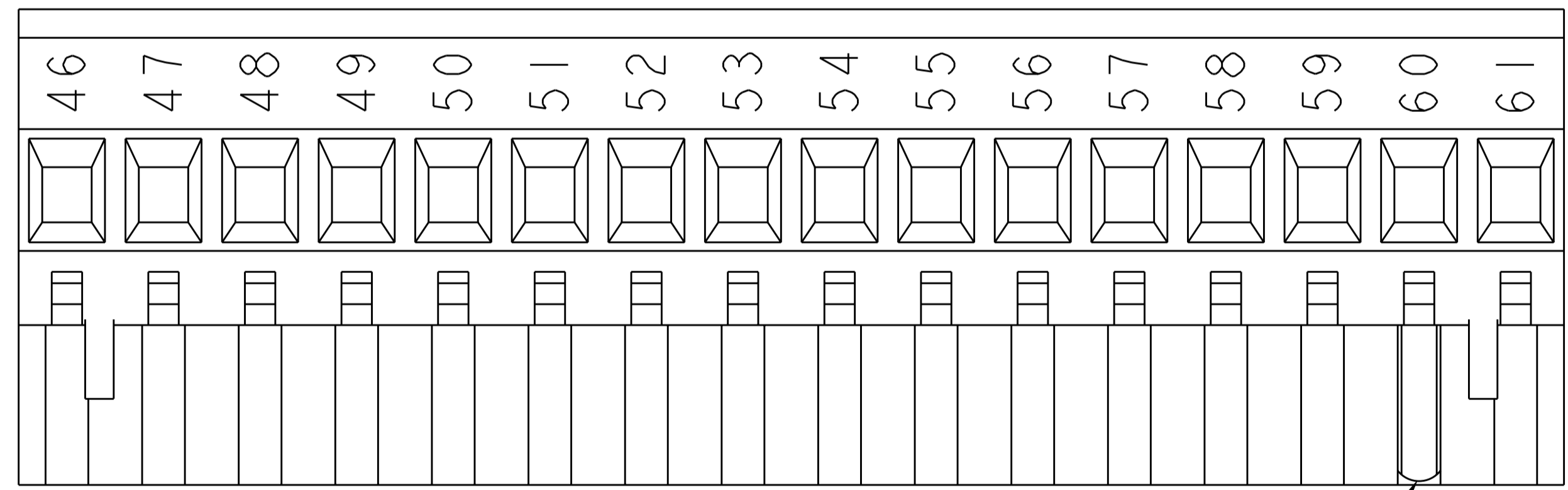

SEE DETAIL X



CODING KEY

<small>THIS DRAWING IS A CONTROLLED DOCUMENT FOR TYCO ELECTRONICS CORPORATION IT IS SUBJECT TO CHANGE AND THE CONTROLLING ENGINEERING ORGANIZATION SHOULD BE CONTACTED FOR THE LATEST REVISION.</small>		DWN S. WELDON 05FEB2003 CHK C. RICHARD 05FEB2003 APVD C. RICHARD 05FEB2003	Tyco Electronics Tyco Electronics Harrisburg, PA 17105-3608
DIMENSIONS: mm 	TOLERANCES UNLESS OTHERWISE SPECIFIED: 0 PLC ±.3 1 PLC ±.3 2 PLC ±.25 3 PLC ±.25 4 PLC ±. ANGLES ±2 FINISH	PRODUCT SPEC - APPLICATION SPEC - WEIGHT -	NAME TERMINAL BLOCK, VERTICAL PLUG, STACKING, RIGHT HAND, 5.08mm PITCH
MATERIAL		CUSTOMER DRAWING	SIZE A200779 CAGE CODE C-284047 DRAWING NO. - RESTRICTED TO -
		SCALE 1:1	SHEET 6 OF 8 REV E10

THIS DRAWING IS UNPUBLISHED. RELEASED FOR PUBLICATION 20
 © COPYRIGHT 20 BY TYCO ELECTRONICS CORPORATION. ALL RIGHTS RESERVED.

LOC	DIST	REVISIONS					
FT	0	P	LTR	DESCRIPTION	DATE	DWN	APVD
		-		SEE SHEET 1			

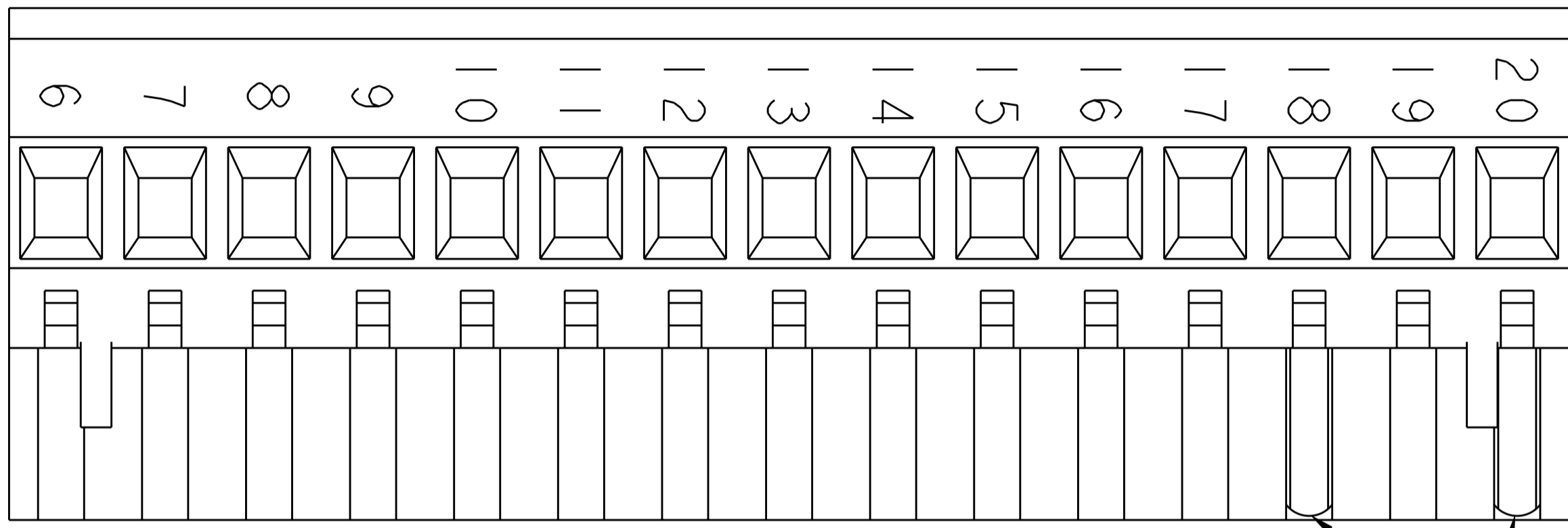

SEE DETAIL A-A

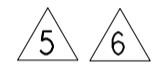

CODING KEY

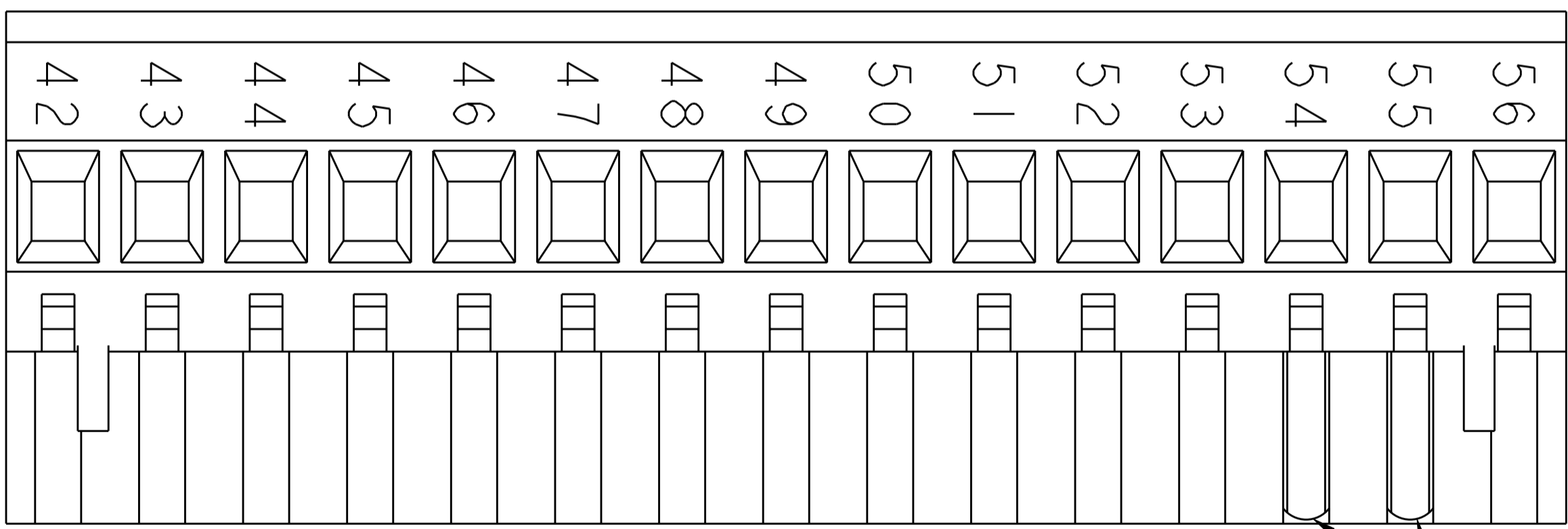

SEE DETAIL A-B

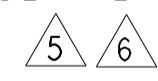

CODING KEY

<small>THIS DRAWING IS A CONTROLLED DOCUMENT FOR TYCO ELECTRONICS CORPORATION IT IS SUBJECT TO CHANGE AND THE CONTROLLING ENGINEERING ORGANIZATION SHOULD BE CONTACTED FOR THE LATEST REVISION.</small>		DWN S. WELDON 05FEB2003 CHK C. RICHARD 05FEB2003 APVD C. RICHARD 05FEB2003	Tyco Electronics Harrisburg, PA 17105-3608
DIMENSIONS: mm 		TOLERANCES UNLESS OTHERWISE SPECIFIED: 0 PLC ±- 1 PLC ±.3 2 PLC ±.25 3 PLC ±- 4 PLC ±- ANGLES ±2 FINISH	NAME: TERMINAL BLOCK, VERTICAL PLUG, STACKING, RIGHT HAND, 5.08mm PITCH SIZE: A200779 CAGE CODE: C-284047 DRAWING NO: 05FEB2003 RESTRICTED TO: -
MATERIAL: -		PRODUCT SPEC: - APPLICATION SPEC: - WEIGHT: -	SCALE: 1:1 SHEET: 7 OF 8 REV: E10

THIS DRAWING IS UNPUBLISHED. RELEASED FOR PUBLICATION 20
 © COPYRIGHT 20 BY TYCO ELECTRONICS CORPORATION. ALL RIGHTS RESERVED.

LOC	DIST	REVISIONS			
P	LTR	DESCRIPTION	DATE	DWN	APVD
FT	0	SEE SHEET 1			

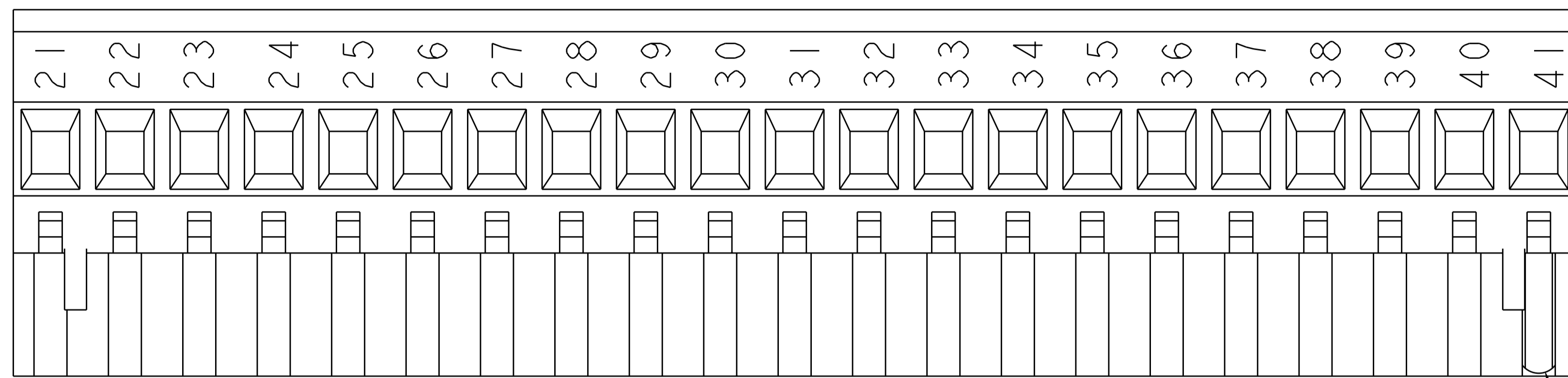

SEE DETAIL A-C
 △5 △6

— CODING KEY

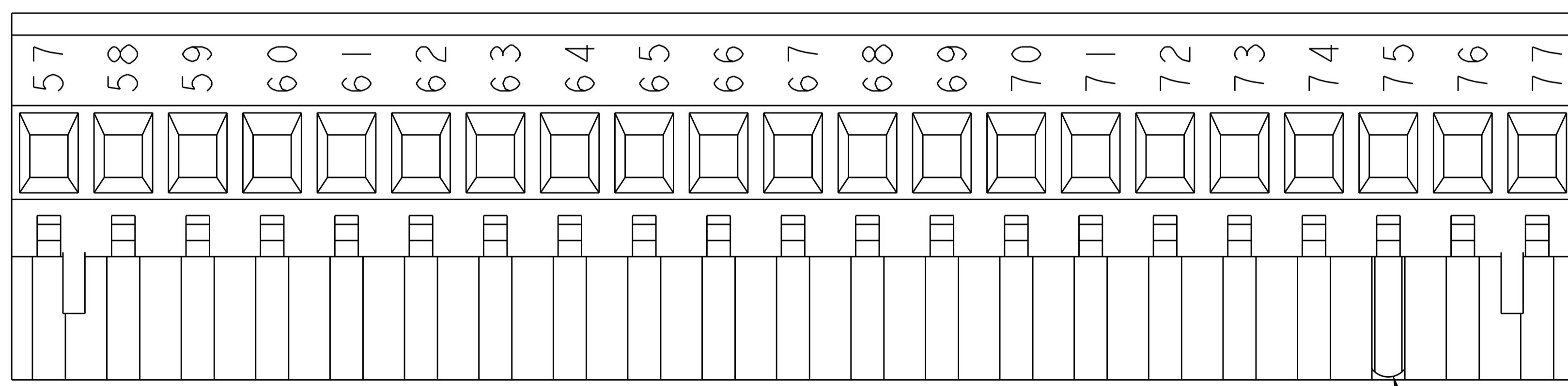

SEE DETAIL A-D
 △5 △6

— CODING KEY

<small>THIS DRAWING IS A CONTROLLED DOCUMENT FOR TYCO ELECTRONICS CORPORATION. IT IS SUBJECT TO CHANGE AND THE CONTROLLING ENGINEERING ORGANIZATION SHOULD BE CONTACTED FOR THE LATEST REVISION.</small>		DWN S. WELDON 05FEB2003 CHK C. RICHARD 05FEB2003 APVD C. RICHARD 05FEB2003	Tyco Electronics Tyco Electronics Harrisburg, PA 17105-3608
DIMENSIONS: mm 	TOLERANCES UNLESS OTHERWISE SPECIFIED: 0 PLC ±- 1 PLC ±.3 2 PLC ±.25 3 PLC ±-. 4 PLC ±- ANGLES ±2 FINISH	PRODUCT SPEC - APPLICATION SPEC - WEIGHT -	NAME TERMINAL BLOCK, VERTICAL PLUG, STACKING, RIGHT HAND, 5.08mm PITCH
MATERIAL -		SIZE A200779 CAGE CODE C-284047 DRAWING NO. - RESTRICTED TO -	SCALE 1:1 SHEET 8 OF 8 REV E10