

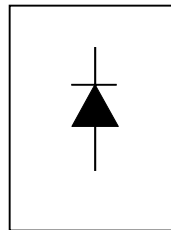

## QUIETIR Series 60EPF.. 60CPF.. HV

### FAST SOFT RECOVERY RECTIFIER DIODE



$V_F < 1.2V @ 30A$   
 $t_{rr} = 95 \text{ ns}$   
 $V_{RRM} 1000 \text{ to } 1200V$

#### Description/Features

The 60EPF.. & 60CPF.. fast soft recovery *QUIETIR* rectifier series has been optimized for combined short reverse recovery time and low forward voltage drop. The glass passivation ensures stable reliable operation in the most severe temperature and power cycling conditions.

Typical applications are both:

- output rectification and freewheeling in inverters, choppers and converters
- and input rectifications where severe restrictions on conducted EMI should be met.

#### Major Ratings and Characteristics

Characteristics	60EPF.. 60CPF..	Units
$I_{F(AV)}$ Sinusoidal waveform	60	A
$V_{RRM}$ range	1000to1200	V
$I_{FSM}$	700	A
$V_F$ @30A, $T_J=25^\circ C$	1.2	V
$t_{rr}$ @1A, -100A/ $\mu s$	95	ns
$T_J$ range	-40to150	$^\circ C$

#### Package Outline

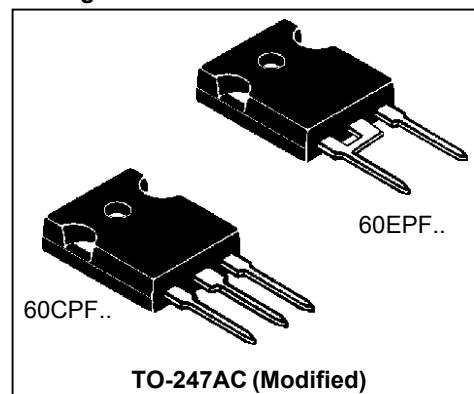

# 60EPF.. 60CPF.. HV QUIETIR Series

Bulletin I2130 rev. B 01/01

International  
**IOR** Rectifier

## Voltage Ratings

Part Number	$V_{RRM}$ , maximum peak reverse voltage V	$V_{RSM}$ , maximum non repetitive peak reverse voltage V	$I_{RRM}$ 150°C mA
60EPF10, 60CPF10	1000	1100	8
60EPF12, 60CPF12	1200	1300	

## Absolute Maximum Ratings

Parameters	60.PF..	Units	Conditions
$I_{F(AV)}$ Max. Average Forward Current	60	A	@ $T_C = 103^\circ\text{C}$ , 180° conduction half sine wave
$I_{FSM}$ Max. Peak One Cycle Non-Repetitive Surge Current	700	A	10ms Sine pulse, rated $V_{RRM}$ applied
	830		10ms Sine pulse, no voltage reapplied
$I^2t$ Max. $I^2t$ for fusing	2450	$A^2s$	10ms Sine pulse, rated $V_{RRM}$ applied
	3460		10ms Sine pulse, no voltage reapplied
$I^2\sqrt{t}$ Max. $I^2\sqrt{t}$ for fusing	34600	$A^2\sqrt{s}$	$t = 0.1$ to 10ms, no voltage reapplied

## Electrical Specifications

Parameters	60.PF..	Units	Conditions
$V_{FM}$ Max. Forward Voltage Drop	1.4	V	@ 60A, $T_J = 25^\circ\text{C}$
$r_t$ Forward slope resistance	4.6	$m\Omega$	$T_J = 125^\circ\text{C}$
$V_{F(TO)}$ Threshold voltage	0.9	V	
$I_{RM}$ Max. Reverse Leakage Current	0.1	mA	$T_J = 25^\circ\text{C}$
	8		$T_J = 150^\circ\text{C}$

$V_R = \text{rated } V_{RRM}$

## Recovery Characteristics

Parameters	60.PF..	Units	Conditions
$t_{rr}$ Reverse Recovery Time	480	ns	$I_F @ 60\text{Apk}$ @ 25A/ $\mu\text{s}$ @ 25°C
$I_{rr}$ Reverse Recovery Current	8	A	
$Q_{rr}$ Reverse Recovery Charge	2.7	$\mu\text{C}$	@ 25°C
S Snap Factor	0.6		

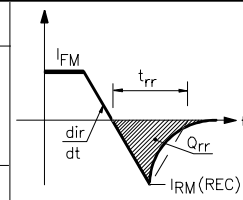

## Thermal-Mechanical Specifications

Parameters	60.PF..	Units	Conditions
$T_J$ Max. Junction Temperature Range	-40 to 150	$^\circ\text{C}$	
$T_{stg}$ Max. Storage Temperature Range	-40 to 150	$^\circ\text{C}$	
$R_{thJC}$ Max. Thermal Resistance Junction to Case	0.4	$^\circ\text{C/W}$	DC operation
$R_{thJA}$ Max. Thermal Resistance Junction to Ambient	40	$^\circ\text{C/W}$	
$R_{thCS}$ Typical Thermal Resistance, Case to Heatsink	0.2	$^\circ\text{C/W}$	Mounting surface, smooth and greased
wt Approximate Weight	6(0.21)	g(oz.)	
T Mounting Torque	Min.	6(5)	Kg-cm (lbf-in)
	Max.	12(10)	
Case Style	TO-247AC		JEDEC (Modified)

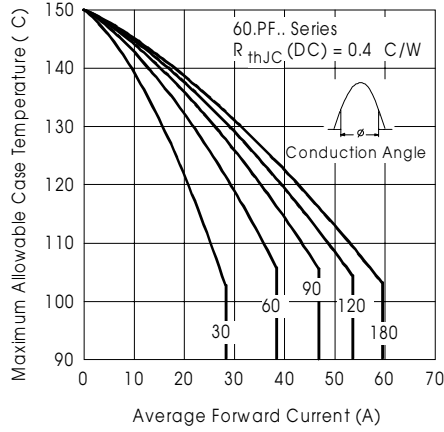

Fig. 1-Current Rating Characteristics

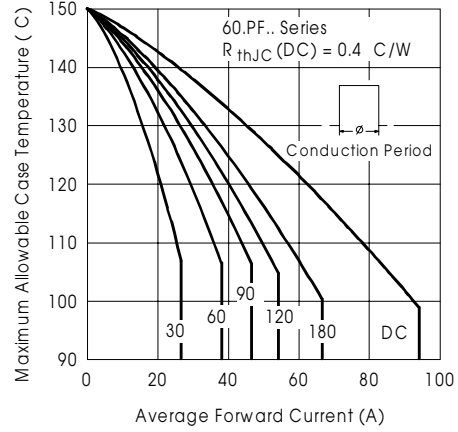

Fig. 2-Current Rating Characteristics

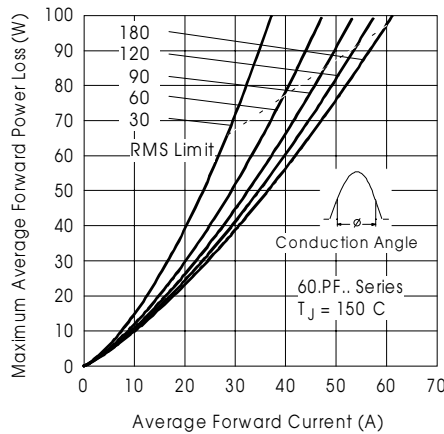

Fig. 3-Forward Power Loss Characteristics

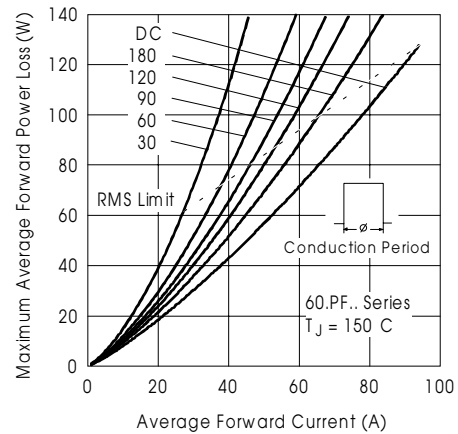

Fig. 4-Forward Power Loss Characteristics

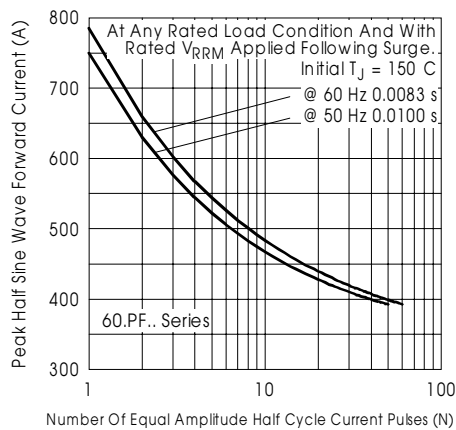

Fig. 5-Maximum Non-Repetitive Surge Current

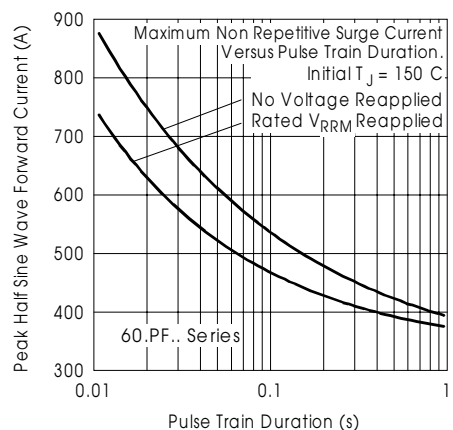

Fig. 6-Maximum Non-Repetitive Surge Current

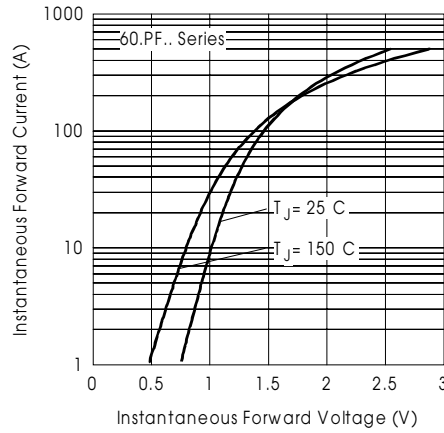

Fig. 7-Forward Voltage Drop Characteristics

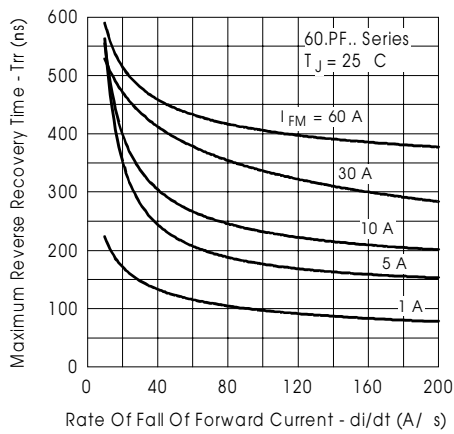

Fig. 8-Recovery Time Characteristics,  $T_J = 25^\circ\text{C}$

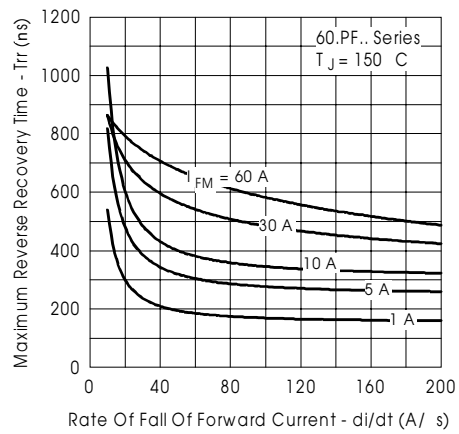

Fig. 9-Recovery Time Characteristics,  $T_J = 150^\circ\text{C}$

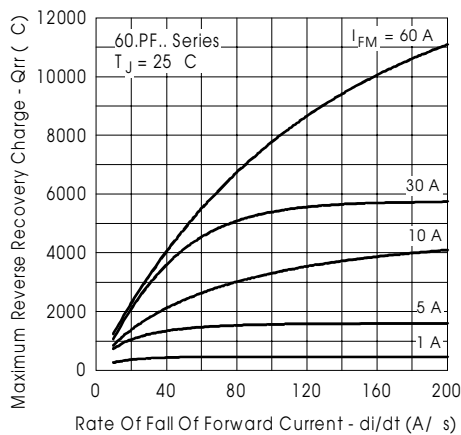

Fig. 10-Recovery Charge Characteristics,  $T_J = 25^\circ\text{C}$

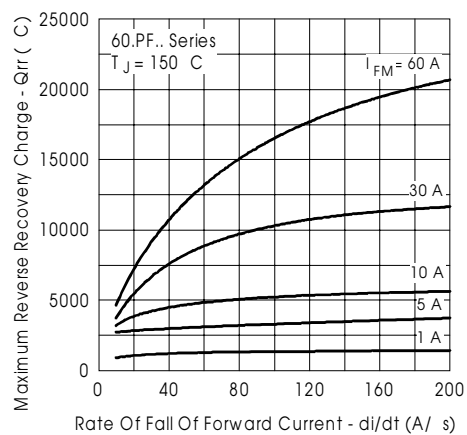

Fig. 11-Recovery Charge Characteristics,  $T_J = 150^\circ\text{C}$

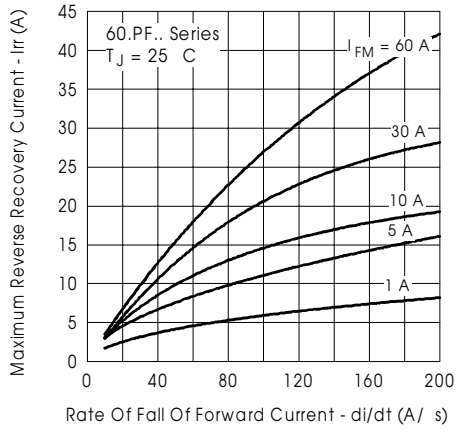

Fig.12-Recovery Current Characteristics,  $T_J = 25^\circ\text{C}$

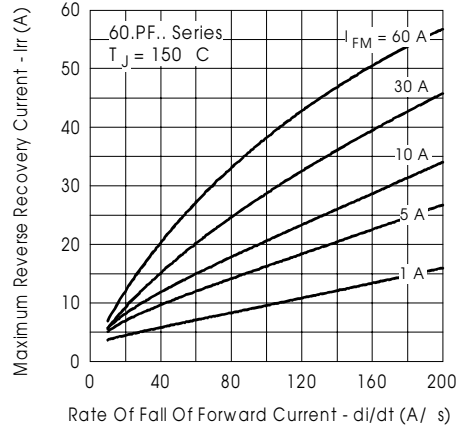

Fig.13-Recovery Current Characteristics,  $T_J = 150^\circ\text{C}$

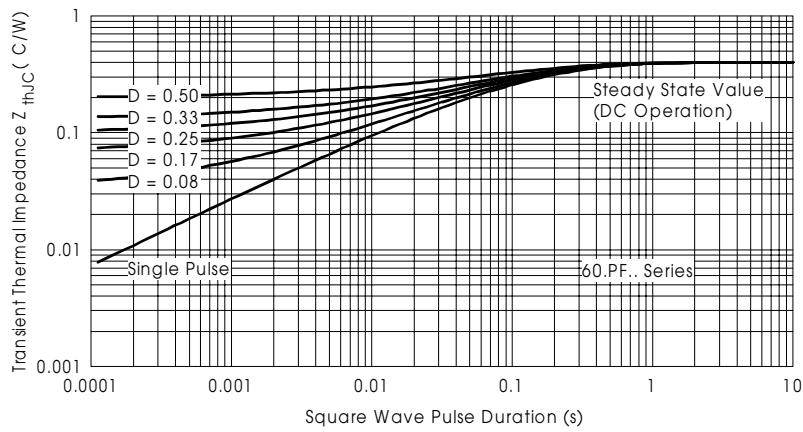
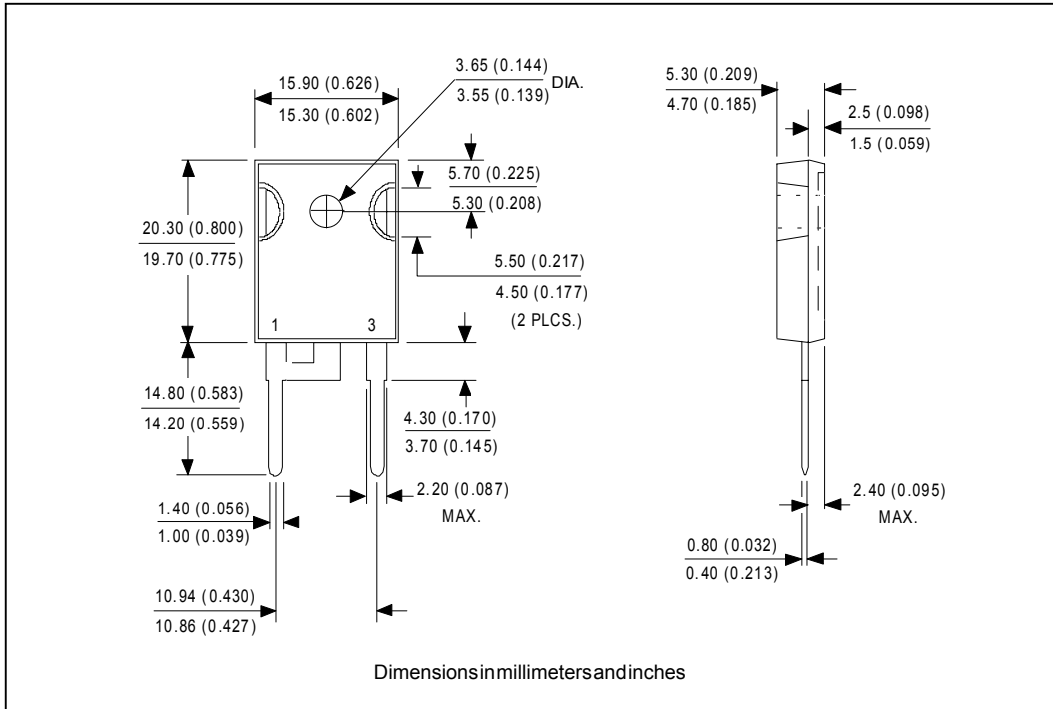
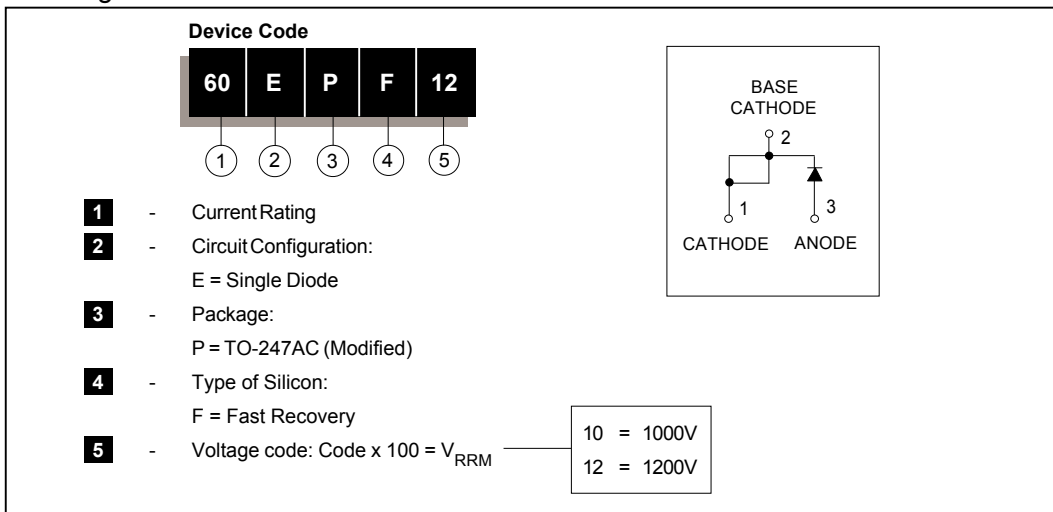

Fig.14-Thermal Impedance  $Z_{thJC}$  Characteristics

Outline Table



Ordering Information Table



Outline Table

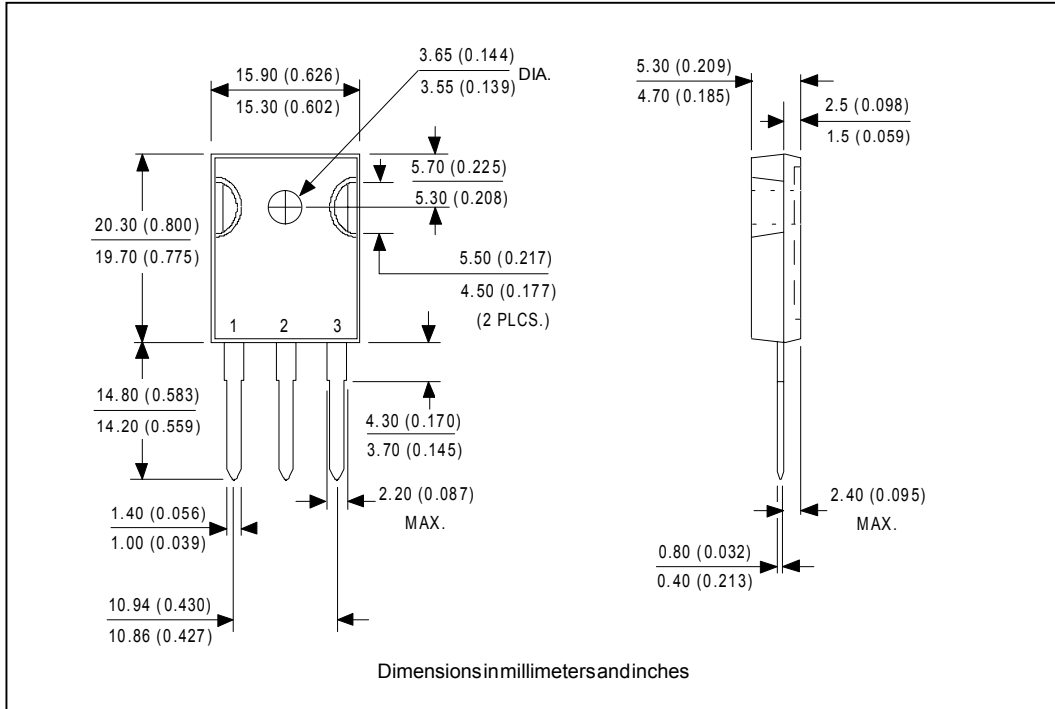

Ordering Information Table

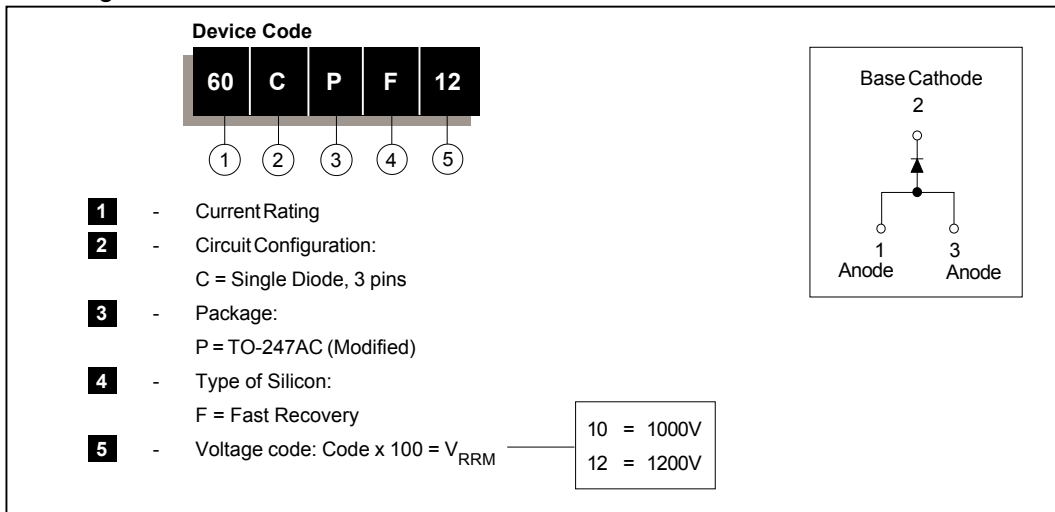

60EPF.. 60CPF.. HV **QUIETIR** Series

Bulletin I2130 rev. B 01/01

International  
**IOR** Rectifier

International  
**IOR** Rectifier

**IR WORLD HEADQUARTERS:** 233 Kansas St., El Segundo, California 90245, USA Tel: (310) 252-7105  
TAC Fax: (310) 252-7309  
01/01





## Notice

The products described herein were acquired by Vishay Intertechnology, Inc., as part of its acquisition of International Rectifier's Power Control Systems (PCS) business, which closed in April 2007. Specifications of the products displayed herein are pending review by Vishay and are subject to the terms and conditions shown below.

Specifications of the products displayed herein are subject to change without notice. Vishay Intertechnology, Inc., or anyone on its behalf, assumes no responsibility or liability for any errors or inaccuracies.

Information contained herein is intended to provide a product description only. No license, express or implied, by estoppel or otherwise, to any intellectual property rights is granted by this document. Except as provided in Vishay's terms and conditions of sale for such products, Vishay assumes no liability whatsoever, and disclaims any express or implied warranty, relating to sale and/or use of Vishay products including liability or warranties relating to fitness for a particular purpose, merchantability, or infringement of any patent, copyright, or other intellectual property right.

The products shown herein are not designed for use in medical, life-saving, or life-sustaining applications. Customers using or selling these products for use in such applications do so at their own risk and agree to fully indemnify Vishay for any damages resulting from such improper use or sale.

International Rectifier®, IR®, the IR logo, HEXFET®, HEXSense®, HEXDIP®, DOL®, INTERO®, and POWIRTRAIN® are registered trademarks of International Rectifier Corporation in the U.S. and other countries. All other product names noted herein may be trademarks of their respective owners.