

PRODUCT NUMBER

XXXXX-YYY HPLF

- LEAD FREE OPTION
SEE NOTE 1,13
- SPECIAL OPTIONS
SEE NOTE 1 OR 10
- HIGH TEMPERATURE PLASTIC
SEE NOTE 1
- NO OF POSITIONS
SEE NOTE 1
- PIN PLATING
SEE SHEET 2
- BASE PART NO.

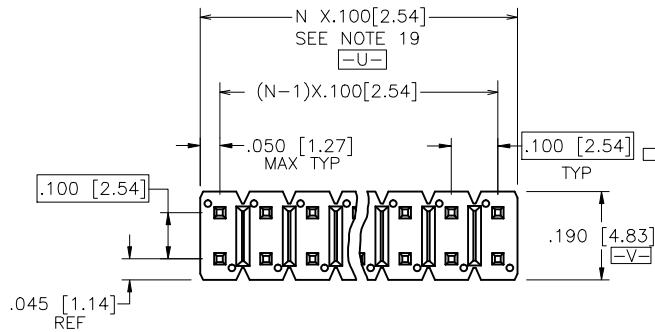

TOP VIEW

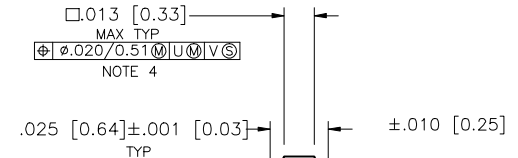

DETAIL P
SCALE 5:1
TYP BOTH ENDS

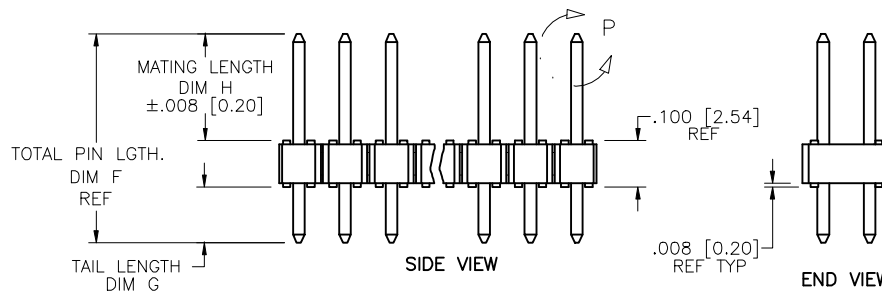

SIDE VIEW

END VIEW

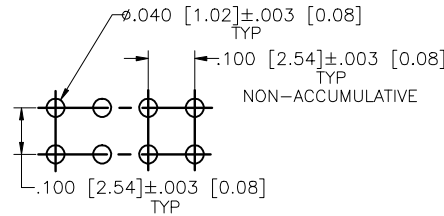

RECOMMENDED HOLE PATTERN

67996-X XX-XXX XXX LF

- TAIL LENGTH (EXAMPLE BELOW)
3.0mm=030 12.8mm=128
(SEE NOTE 16 & 17)
- MATING LENGTH (EXAMPLE BELOW)
5.0mm=050 25.5mm=255
(SEE NOTE 16 & 17)
- TOTAL NUMBER OF POSITIONS
FROM 2 (2X1) THRU 72 (2X36) POS.
- PIN PLATING (SEE NOTE 14)
1=0.76µm Au
4= PURE TIN
8=0.36µm Au
- BASE PART NO.
DOUBLE ROW

mat'l code SEE NOTES 2 & 3		surface ISO 1302	tolerance ISO 406 ISO 1101	projection	product family BERGSTIK
lir	ec'n no	dr	date	INCH/MM	title BERGSTIK® II HDR. D/R .100/2.54cc STRAIGHT
CW	M06-0268	MHT	7/17/06	linear	dwg no 67996
CX	M06-0346	MHT	9/04/06	0° ± 2'	sheet 1 of 8 size A3
CY	M06-0468	MHT	11/27/06	scale 1:1	type Product Customer Drawing
DA	M08-0169	MHT	2/20/08	dr	T.BREWBAKER 12/21/94
DB	M08-0272	MHT	9/25/08	engr	T.HANNA 12/21/94
DC	M08-0331	MHT	12/01/08	chr	J.MURPHY 12/21/94
DD	M09-0108	MHT	7/10/09	appd	T.HANNA 12/21/94
sheet	revision	DD	DD	DD	DD
index	sheet	1	2	3	4

PIN PLATING CODES:	
XXXX-1YY	30u"/0.76u MIN (SEE NOTE 14) OVER 50u"/1.27u MIN Ni
XXXX-2YY	15u"/0.38u MIN (SEE NOTE 14) OVER 50u"/1.27u MIN Ni
XXXX-3YY	50u"/1.27u MIN Au OVER 50u"/1.27u MIN Ni
XXXX-4YY	100u"/2.54u MIN Sn OVER 50u"/1.27u MIN Ni (SEE NOTE 15)
XXXX-4YYHLF	
XXXX-5YY	15u"/0.38u MIN (SEE NOTE 14) OVER 50u"/1.27u MIN Ni
XXXX-6YY	30u"/0.76u MIN (SEE NOTE 14) OVER 50u"/1.27u MIN Ni
XXXX-7YY	30u"/0.76u MIN Au OVER 50u"/1.27u MIN Ni
XXXX-8YY	15u"/0.38u MIN Au OVER 50u"/1.27u MIN Ni
XXXX-9YY	15u"/0.38u MIN GXT OVER 50u"/1.27u MIN Ni
XXXX-0YY	30u"/0.76u MIN GXT OVER 50u"/1.27u MIN Ni

NOTES

① PART NUMBER OPTIONS:
PIN PLATING CODES (SEE ABOVE)

HIGH TEMPERATURE MATERIAL:
PART NUMBERS WITH AND WITHOUT "H" WILL BE SUPPLIED WITH HIGH TEMPERATURE PLASTIC.

NUMBER OF POSITIONS :
EVEN NUMBER OF POSITIONS FROM 2 (2X1) THROUGH 72 (2X36).
-X00H INDICATES BERGSTRIIP PRODUCT. SEE PAGE 3
FOR SPECIAL GEOMETRY OF THIS CONTINUOUS STRIP PRODUCT.
AUTOMATED REELS WILL CONTAIN 45,000 PINS.
SEE SPECIFIC PART NUMBERS FOR AVAILABILITY.

PACKAGING:
PACKAGED IN POLY BAGS.
EIGHT DIGIT PART NUMBERS FOLLOWED BY A "T" ARE PACKAGED IN TUBES. SEE SPECIFIC PART NUMBERS FOR AVAILABILITY.
EIGHT DIGIT PART NUMBERS FOLLOWED BY A "G" ARE PACKAGED IN GPAX FOR IBM ONLY. SEE SPECIFIC PART NUMBERS FOR AVAILABILITY.
PART NUMBERS FOLLOWED BY A "C" ARE PACKAGED IN TUBES WITH A PICKUP CAP APPLIED.

LEAD FREE:
ADD "HLF" SUFFIX AT THE END OF PART NUMBER FOR LEAD FREE OPTION, NOT AVAILABLE FOR -5YY, -5YYH, -6YY & -6YYH

② BODY MATERIAL:
BODY MATERIAL : MANUFACTURER'S OPTION OF NYLON, PCT GLASS FIBER REINFORCED OR MINERAL FILLED LCP FLAME RETARDENT PER UL-94V-0.
COLOR: BLACK
BERGSTRIIP™ PRODUCED WITH HIGH TEMPERATURE LCP THERMOPLASTIC, FLAME RETARDENT PER UL-94V-0.
COLOR: BLACK
PART NUMBERS WITH "H" AND WITHOUT SUFFIX WILL WITHSTAND EXPOSURE TO 260° C PEAK TEMPERATURE FOR 20 SECONDS IN WAVE SOLDER, INFRA-RED OR VAPOR PHASE SOLDER PROCESS.

- ③ PIN MATERIAL: PHOS BRONZE.
- ④ MEASURED WITH PART IN RESTRAINED CONDITION.
- 5. TWO SIDES OF PIN TIPS NOT PLATED. TYPICAL BOTH ENDS.
- ⑥ 2LBS/0.9KG MIN PIN RETENTION IN EITHER DIRECTION.
- 7. MILITARY BERGSTIK HEADER
P/N XXXXX-YYY-MIL
NOT AVAILABLE.
- ⑧ ±.010/0.25 TOL APPLIES TO ALL "G" TAILS EXCEPT INDICATED PARTS ON TABLE WHERE +.010/0.25 -.000/0.00 APPLIES.
- ⑨ NOTCH CONFIGURATION WILL VARY PER VENDOR'S DISCRETION.
- ⑩ BERGSTRIIP™ PART NUMBERS FOLLOWED BY BY A "B" ARE BULK PRICED.
- ⑪ TAIL LENGTH (DIM. G) TO BE ±.008/.020.
- 12. POSITIONS PER ROW 37 TO 50 CAN BE PRODUCED, BUT FLATNESS AND CURVATURE MAY NOT BE HELD AS CLOSE AS 36 POSITIONS.
- ⑬ THESE PRODUCTS MEETS EUROPEAN UNION DIRECTIVES AND OTHER COUNTRY REGULATION AS DESCRIBED IN GS-22-008.
- ⑭ PLATING OPTIONS:
MAY BE EITHER GOLD OR GXT PLATED AT MANUFACTURER'S OPTION.
- ⑮ "THIS PRODUCT HAS 100% TIN PLATING IN THE INTERFACE AND HAS NOT BEEN TESTED FOR WHISKER GROWTH IN ALL INTERCONNECT ENVIRONMENTS."
- ⑯ THE OAL DON'T EXCEED 34.5mm
- ⑰ INCREMENTS BY 0.1mm IN LENGTHS ONLY
- 18. FOR SPECIAL PACKAGING REQUEST PLEASE CONTACT PRODUCT MANAGER FOR AVAILABILITY
- ⑲ TO DETERMINE DIMENSIONS:
N=NUMBER OF POSITION PER ROW
EXAMPLE: 10 POS. N X .100/2.54

mat'l code SEE NOTES 2 & 3		surface ISO 1902 ✓	tolerance ISO 406 ISO 1101	projection INCH/MM	product family BERGSTIK
titl ecn no	dr date	tolerances unless otherwise specified		INCH/MM	title BERGSTIK II HDR. D/R .100/2.54cc STRAIGHT
DD		angles	linear	scale 1:1	dwg no 67996
		0±.2	XXXX.005/XXX0.13 XXXX.0020/XXX0.05		sheet 2 of 8 size A3
		dr	T.BREWBAKER 12/21/94		type Product Customer Drawing
		engr	T.HANNA 12/21/94		
		chr	J.MURPHY 12/21/94		
		appd	T.HANNA 12/21/94		
sheet	revision				
index	sheet				



Copyright FCI

1 2 3 4 5 6

BERGSTRIPTM HEADER

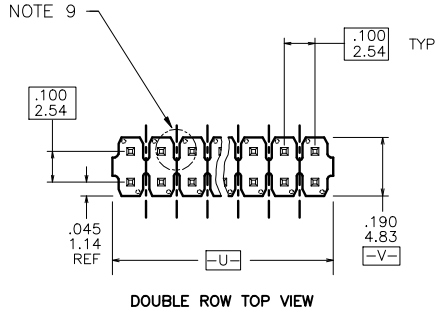

REEL PACKING DIMENSIONS

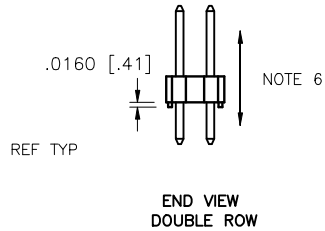
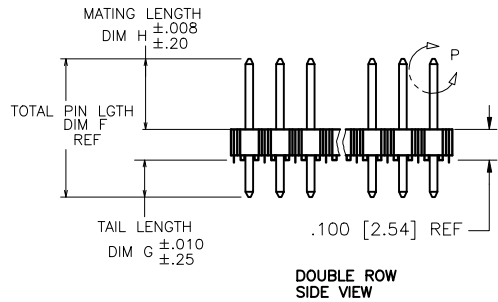
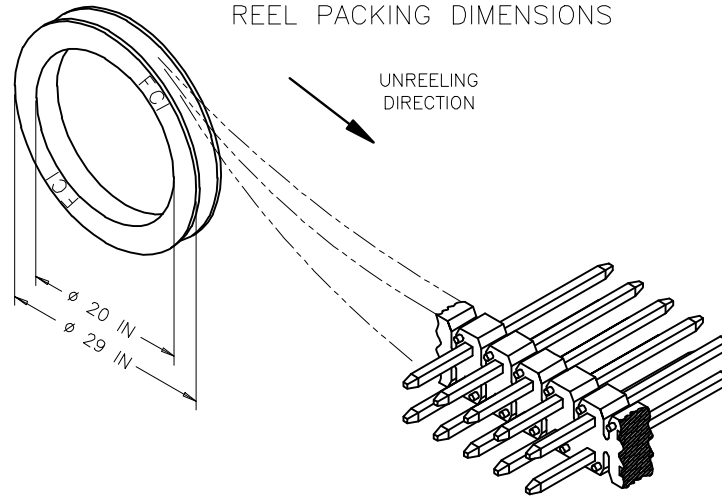

FCIconnect.com

Copyright FCI

mat'l. code SEE NOTES 2 & 3		surface ISO 1302	tolerance ISO 406 ISO 1101	projection FIRST ANGLE	product family BERGSTIK
Utr	ecn no	dr	date	tolerances unless otherwise specified	title BERGSTIK II HDR. D/R .100/2.54cc STRAIGHT
DD				angles linear XX±.01/XX±0.3 XXX±.005/XXX±0.13 XXXX±.0020/XXX±0.05	INCH/MM scale 1:1
		dr	T.BREWBAKER 12/21/94		dwg no 67996
		enr	T.HANNA 12/21/94		sheet 3 of 8 size A3
		chr	J.MURPHY 12/21/94		type Product Customer Drawing
		appd	T.HANNA 12/21/94		
sheet index	revision sheet				

Form A3

1 2 3 4 5 6

PRODUCT NUMBER	TOT. PIN LGTH.		TAIL LENGTH		MATING LENGTH		PACKAGING	NOTES	BERGSTRIIP™ AVAILABLE	LF OPTION
	DIM F	DIM F	DIM G	DIM G	DIM H	DIM H				
	ENGLISH	METRIC	ENGLISH	METRIC	ENGLISH	METRIC				
55005-XYH	0.597	15.16	0.095	2.41	0.402	10.21	POLY BAGS	-	YES	NOTE 1,13
55030-XYH	0.630	16.00	0.150	3.81	0.380	9.65	POLY BAGS	-	YES	
67996-XY	0.425	10.80	0.095	2.41	0.230	5.84	POLY BAGS/TUBES	-	YES	
67997-XY	0.450	11.43	0.120	3.05	0.230	5.84	POLY BAGS/TUBES	-	YES	
67997-XYH	0.450	11.43	0.120	3.05	0.230	5.84	POLY BAGS/TUBES	-	YES	
67998-XY	0.525	13.34	0.107	2.72	0.318	8.08	POLY BAGS/TUBES	-	YES	
67999-XY	0.548	13.92	0.130	3.30	0.318	8.08	POLY BAGS	-	NO	
68438-XY	0.555	14.10	0.225	5.72	0.230	5.84	POLY BAGS/TUBES	-	NO	
68439-XY	0.720	18.29	0.120	3.05	0.500	12.70	POLY BAGS	-	NO	
68464-XY	0.650	16.51	0.120	3.05	0.430	10.92	POLY BAGS/TUBES	-	NO	
68481-XY	0.480	12.19	0.095	2.41	0.285	7.24	POLY BAGS/TUBES	-	NO	
68482-XY	0.938	23.83	0.318	8.08	0.520	13.21	POLY BAGS	-	NO	
68491-XY	0.475	12.07	0.120	3.05	0.255	6.48	POLY BAGS/TUBES	-	NO	
68600-XY	0.825	20.96	0.115	2.92	0.610	15.49	POLY BAGS	-	NO	
68601-XY	0.620	15.75	0.120	3.05	0.400	10.16	POLY BAGS	-	NO	
68602-XY	0.480	12.19	0.150	3.81	0.230	5.84	POLY BAGS	-	NO	
68690-XY	0.533	13.54	0.115	2.92	0.318	8.08	POLY BAGS	-	NO	
68691-XY	0.538	13.67	0.120	3.05	0.318	8.08	POLY BAGS	-	YES	
68692-XY	0.430	10.92	0.100	2.54	0.230	5.84	POLY BAGS	-	NO	
68693-XY	0.938	23.83	0.520	13.21	0.318	8.08	POLY BAGS	-	NO	
68716-XY	0.828	21.03	0.410	10.41	0.318	8.08	POLY BAGS	-	NO	
68734-XY	0.615	15.62	0.230	5.84	0.285	7.24	POLY BAGS	-	NO	
68737-XY	0.440	11.18	0.110	2.79	0.230	5.84	POLY BAGS	-	YES	
68738-XY	0.615	15.62	0.115	2.92	0.400	10.16	POLY BAGS	-	NO	
68739-XY	0.486	12.34	0.156	3.96	0.230	5.84	POLY BAGS	-	NO	
68743-XY	0.638	16.21	0.220	5.59	0.318	8.08	POLY BAGS	-	NO	
68749-XY	0.838	21.29	0.420	10.67	0.318	8.08	POLY BAGS	-	NO	
68779-XY	0.736	18.69	0.318	8.08	0.318	8.08	POLY BAGS	-	NO	
68783-XY	0.375	9.53	0.045	1.14	0.230	5.84	POLY BAGS	-	NO	
68799-XY	0.925	23.50	0.595	15.11	0.230	5.84	POLY BAGS	-	NO	

NOTE 1,13



FCconnect.com

Copyright FCJ

mat'l. code SEE NOTES 2 & 3		surface ISO 1302	tolerance ISO 406 ISO 1301	projection 	product family BERGSTIK
ltr	ecn no	dr	date	tolerances unless otherwise specified	title BERGSTIK II HDR. D/R
DD				linear XX±.01/XX±0.3 XXX±.006/XXX±0.13 0'±2'	.100/2.54cc STRAIGHT
				scale 1:1	dwg no 67996
		dr	T.BREWBAKER	12/21/94	sheet 4 of 8 size A3
		engr	T.HANNA	12/21/94	
		chr	J.MURPHY	12/21/94	
		appd	T.HANNA	12/21/94	type Product Customer Drawing
sheet index	revision sheet				

Form A3 1 2 3 4 5 6

PRODUCT NUMBER	TOT. PIN LGTH.		TAIL LENGTH		MATING LENGTH		PACKAGING	NOTES	BERGSTRIPTM AVAILABLE	LF OPTION
	DIM F	DIM F	DIM G	DIM G	DIM H	DIM H				
	ENGLISH	METRIC	ENGLISH	METRIC	ENGLISH	METRIC				
69132-YYY	0.760	19.30	0.120	3.05	0.540	13.72	POLY BAGS/TUBES	-	NO	NOTE 1,13
69133-YYY	0.615	15.62	0.285	7.24	0.230	5.84	POLY BAGS	-	NO	
69157-YYY	0.410	10.41	0.110	2.79	0.200	5.08	POLY BAGS	-	NO	
71217-YYYH	1.000	25.40	0.450	11.43	0.450	11.43	POLY BAGS	-	NO	
71222-YYYH	0.850	21.59	0.250	6.35	0.500	12.70	POLY BAGS	-	NO	
72273-YYYH	0.725	18.42	0.110	2.79	0.515	13.08	POLY BAGS	-	NO	
72448-YYYH	0.658	16.71	0.172	4.37	0.386	9.80	POLY BAGS	-	NO	
72455-YYYH	0.598	15.19	0.180	4.57	0.318	8.08	POLY BAGS	-	NO	
72455-632HG	0.598	15.19	0.180	4.57	0.318	8.08	GPAX	NOTE 1	NO	
73503-YYYH	0.420	10.67	0.120	3.05	0.200	5.08	POLY BAGS	-	NO	
73596-YYYH	0.795	20.19	0.110	2.79	0.585	14.86	POLY BAGS	-	NO	
74317-YYYH	0.532	13.51	0.309	7.85	0.123	3.12	POLY BAGS	NOTE 11	NO	
74318-YYYH	0.592	15.04	0.369	9.37	0.123	3.12	POLY BAGS	NOTE 11	NO	
74999-YYYH	0.508	12.90	0.090	2.29	0.318	8.08	POLY BAGS	-	NO	
78212-YYY	0.710	18.03	0.350	8.89	0.260	6.60	POLY BAGS	-	NO	
78233-YYY	0.568	14.43	0.150	3.81	0.318	8.08	POLY BAGS	-	NO	
78269-YYY	0.385	9.78	0.095	2.41	0.190	4.83	POLY BAGS	-	NO	
78286-YYY	0.500	12.70	0.160	4.06	0.240	6.10	POLY BAGS/TUBES	-	NO	
78932-YYY	UNAVAILABLE	UNAVAILABLE	UNAVAILABLE	UNAVAILABLE	UNAVAILABLE	UNAVAILABLE		-	-	
78933-YYY	0.695	17.65	0.285	7.24	0.310	7.87	POLY BAGS	-	NO	
78988-YYY	0.540	13.72	0.135	3.43	0.305	7.75	POLY BAGS	-	NO	
78989-YYY	UNAVAILABLE	UNAVAILABLE	UNAVAILABLE	UNAVAILABLE	UNAVAILABLE	UNAVAILABLE		-	-	
78990-YYY	UNAVAILABLE	UNAVAILABLE	UNAVAILABLE	UNAVAILABLE	UNAVAILABLE	UNAVAILABLE		-	-	
78991-YYY	UNAVAILABLE	UNAVAILABLE	UNAVAILABLE	UNAVAILABLE	UNAVAILABLE	UNAVAILABLE		-	-	
78992-YYY	UNAVAILABLE	UNAVAILABLE	UNAVAILABLE	UNAVAILABLE	UNAVAILABLE	UNAVAILABLE		-	-	
78993-YYY	UNAVAILABLE	UNAVAILABLE	UNAVAILABLE	UNAVAILABLE	UNAVAILABLE	UNAVAILABLE		-	-	
78994-YYY	UNAVAILABLE	UNAVAILABLE	UNAVAILABLE	UNAVAILABLE	UNAVAILABLE	UNAVAILABLE		-	-	



FCJconnect.com

Copyright FCJ

mat'l. code SEE NOTES 2 & 3		surface ISO 1302	tolerance ISO 406 ISO 1101	projection 	product family BERGSTIK
ltr	ech no	dr	date	tolerances unless otherwise specified	title BERGSTIK® II HDR. D/R .100/2.54cc STRAIGHT
DD				angles linear XX±.01/XX±0.3 XXX±.005/XXX±0.13 XXXX±.0020/XXX±0.05	INCH/MM scale 1:1
				dr T.BREWBAKER 12/21/94	dwg no 67996
				engr T.HANNA 12/21/94	sheet 5 of 8 size A3
				chr J.MURPHY 12/21/94	type Product Customer Drawing
				appd T.HANNA 12/21/94	
sheet	revision				
index	sheet				

form: A3

PRODUCT NUMBER	TOT. PIN LGTH.		TAIL LENGTH		MATING LENGTH		PACKAGING	NOTES	BERGSTRIPTM AVAILABLE	LF OPTION	
	DIM F	DIM F	DIM G	DIM G	DIM H	DIM H					
	ENGLISH	METRIC	ENGLISH	METRIC	ENGLISH	METRIC					
78995-YYY	UNAVAILAB	LE	UNAVAILAB	LE	UNAVAILAB	LE	UNAVAILAB	LE	-	-	NOTE 1,13
78996-YYY	UNAVAILAB	LE	UNAVAILAB	LE	UNAVAILAB	LE	UNAVAILAB	LE	-	-	
79242-YYY	0.930	23.62	0.340	8.64	0.490	12.45	POLY BAGS	-	NO		
79243-YYY	1.230	31.24	0.390	9.91	0.740	18.80	POLY BAGS	-	NO		
79244-YYY	UNAVAILAB	LE	UNAVAILAB	LE	UNAVAILAB	LE	UNAVAILAB	LE	-	-	
79268-YYY	1.020	25.91	0.120	3.05	0.800	20.32	POLY BAGS	-	NO		
79271-YYY	1.100	27.94	0.500	12.70	0.500	12.70	POLY BAGS	-	NO		
79425-YYY	0.410	10.41	0.120	3.05	0.190	4.83	POLY BAGS	-	NO		
79821-YYY	0.730	18.54	0.200	5.08	0.430	10.92	POLY BAGS	-	NO		
84610-XXYH	0.380	9.65	0.120	3.05	0.160	4.06	POLY BAGS	-	NO		
84760-XXYH	0.870	22.09	0.150	3.81	0.620	15.74	POLY BAGS	-	NO		
84784-XXYH	1.130	28.70	0.122	3.09	0.908	23.06	POLY BAGS	-	NO		
84934-XXYH	1.375	34.93	0.625	15.88	0.650	16.51	POLY BAGS	-	NO		
84976-XXYH	0.730	18.54	0.400	10.16	0.230	5.84	POLY BAGS	-	NO		
86503-YYY	0.470	11.94	0.120	3.05	0.250	6.35	POLY BAGS	-	NO		
86581-YYY	0.450	11.43	0.120	3.05	0.230	5.84	POLY BAGS	NOTE 8	NO		
86817-YYY	0.925	23.50	0.120	3.05	0.705	17.91	POLY BAGS	-	NO		
86827-YYY	0.700	17.78	0.120	3.05	0.480	12.19	POLY BAGS	-	NO		
86832-YYY	0.525	13.34	0.100	2.54	0.325	8.26	POLY BAGS	-	NO		
86834-YYY	1.335	33.91	0.585	14.86	0.650	16.51	POLY BAGS	-	NO		
86836-YYY	0.870	22.10	0.120	3.05	0.650	16.51	POLY BAGS	-	NO		
86837-YYY	0.600	15.24	0.120	3.05	0.380	9.65	POLY BAGS	-	NO		
87037-YYY	1.240	31.50	0.120	3.05	1.020	25.91	POLY BAGS	-	NO		
87052-YYY	0.990	25.15	0.120	3.05	0.770	19.56	POLY BAGS	-	NO		
87203-YYY	0.545	13.84	0.150	3.81	0.295	7.49	POLY BAGS	-	NO		
87344-YYY	1.375	34.93	0.219	5.56	1.056	26.82	POLY BAGS	-	NO	NOTE 1,13	



FCJconnect.com

Copyright FCJ

mat'l. code SEE NOTES 2 & 3		surface ISO 1302	tolerance ISO 406 ISO 1101	projection 	product family BERGSTIK
ltr	ecdn no	dr	date	tolerances unless otherwise specified	
DD				linear	XX±.01/XX±0.3
				0'±2'	XXX±.005/XXX±0.13
					XXXX±.0020/XXXX±0.051
		dr	T.BREWBAKER	12/21/94	
		engr	T.HANNA	12/21/94	
		chr	J.MURPHY	12/21/94	
		appd	T.HANNA	12/21/94	
sheet	revision				
index	sheet				
				INCH/MM	scale 1:1
				title BERGSTIK® II HDR. D/R .100/2.54cc STRAIGHT	
				dwg no	sheet 6 of 8 size
				67996	A3
				type Product Customer Drawing	

form: A3

PRODUCT NUMBER	TOT. PIN LGTH.		TAIL LENGTH		MATING LENGTH		PACKAGING	NOTES	BERGSTRIPT™ AVAILABLE	LF OPTION
	DIM F	DIM F	DIM G	DIM G	DIM H	DIM H				
	ENGLISH	METRIC	ENGLISH	METRIC	ENGLISH	METRIC				
87345-XYX	1.218	30.94	0.406	10.31	0.712	18.08	POLY BAGS	-	NO	NOTE 1,13
87348-XYX	0.930	23.62	0.100	2.54	0.730	18.54	POLY BAGS	-	NO	
87349-XYX	0.890	22.61	0.110	2.79	0.680	17.27	POLY BAGS	-	NO	
87381-XYX	0.645	16.38	0.100	2.54	0.445	11.30	POLY BAGS	-	NO	
87382-XYX	0.675	17.15	0.100	2.54	0.475	12.07	POLY BAGS	-	NO	
87503-XYXH	0.630	16.00	0.110	2.79	0.420	10.67	POLY BAGS	-	NO	
87869-XYX	0.690	17.53	0.230	5.84	0.360	9.14	POLY BAGS	-	NO	
87894-XYX	0.588	14.94	0.170	4.32	0.318	8.08	POLY BAGS	-	NO	
87900-XYX	0.940	23.88	0.120	3.05	0.720	18.29	POLY BAGS	-	NO	
87901-XYX	1.040	26.42	0.120	3.05	0.820	20.83	POLY BAGS	-	NO	
87903-XYX	0.963	24.46	0.337	8.56	0.526	13.36	POLY BAGS	-	NO	
88797-XYX	0.950	24.13	0.320	8.13	0.530	13.46	POLY BAGS	-	NO	
88812-XYX	0.415	10.54	0.085	2.16	0.230	5.84	POLY BAGS/TUBES	NOTE 8	NO	
88886-XYX	1.306	33.17	0.276	7.01	0.930	23.62	POLY BAGS	-	NO	
89446-XYX	0.930	23.62	0.120	3.05	0.710	18.03	POLY BAGS	-	NO	
89540-XYX	0.760	19.30	0.280	7.11	0.380	9.65	POLY BAGS	-	NO	
89542-XYX	1.065	27.05	0.125	3.18	0.840	21.34	POLY BAGS	-	NO	
89639-XYX	1.260	32.00	0.118	3.00	1.042	26.47	POLY BAGS	-	NO	
91828-XYX	0.450	11.43	0.120	3.05	0.230	5.84	TUBES	-	NO	
92417-XYX	0.530	13.46	0.110	2.79	0.320	8.13	POLY BAGS	-	NO	
93216-XYXH	0.573	14.55	0.155	3.94	0.318	8.08	POLY BAGS/TUBES	-	NO	
93216-632HG	0.573	14.55	0.155	3.94	0.318	8.08	GPAX	NOTE 1	NO	
93217-XYXH	0.395	10.03	0.095	2.41	0.200	5.08	POLY BAGS	-	NO	
93254-XYX	0.563	14.30	0.110	2.79	0.353	8.97	POLY BAGS	-	NO	



FCJconnect.com

Copyright FCJ

mat'l. code SEE NOTES 2 & 3		surface ISO 1302	tolerance ISO 406 ISO 1101	projection 	product family BERGSTIK
lfr	ecdn no	dr	date	tolerances unless otherwise specified	title BERGSTIK® II HDR. D/R .100/2.54cc STRAIGHT
DD				angles linear XX±.01/XX±0.3 XXX±.005/XXX±0.13 XXXX±.0020/XXX±0.05	INCH/MM scale 1:1
				dr T.BREWBAKER 12/21/94	dwg no 67996
				engr T.HANNA 12/21/94	sheet 7 of 8 size A3
				chr J.MURPHY 12/21/94	type Product Customer Drawing
				appd T.HANNA 12/21/94	
sheet index	revision				
	sheet				

form: A3

PRODUCT NUMBER	1 TOT. PIN LGTH.		TAIL LENGTH		2 3 MATING LENGTH		PACKAGING	NOTES	BERGSTRIPTM AVAILABLE	LF OPTION
	DIM F	DIM F	DIM G	DIM G	DIM H	DIM H				
	ENGLISH	METRIC	ENGLISH	METRIC	ENGLISH	METRIC				
94010-XYH	0.756	19.20	0.350	8.89	0.306	7.77	POLY BAGS	-	NO	NOTE 1,13 ↓
94532-XYH	1.250	31.75	0.450	11.43	0.700	17.78	POLY BAGS	-	NO	
95105-XYH	0.370	9.40	0.126	3.20	0.144	3.66	POLY BAGS	-	NO	
95645-XYH	0.350	8.89	0.100	2.54	0.150	3.81	POLY BAGS	-	NO	
95652-XYH	0.500	12.70	0.070	1.78	0.330	8.38	POLY BAGS	-	NO	
95665-XYH	0.835	21.21	0.335	8.51	0.400	10.16	POLY BAGS	-	NO	
A 95687-XYH	0.820	20.83	0.360	9.14	0.360	9.14	POLY BAGS	-	NO	
95712-XYH	1.090	27.69	0.110	2.79	0.880	22.35	POLY BAGS	-	NO	
95727-XYH	0.825	20.96	0.110	2.79	0.615	15.62	POLY BAGS	-	NO	
98181-XYH	0.760	19.30	0.218	5.54	0.442	11.23	POLY BAGS	-	NO	
98217-XYH	0.756	19.20	0.328	8.33	0.328	8.33	POLY BAGS	-	NO	
98329-XYH	0.930	23.62	0.415	10.54	0.415	10.54	POLY BAGS	-	NO	
98854-XYH	0.450	11.43	0.120	3.05	0.230	5.84	TUBES	-	NO	
10017852-XYH	0.450	11.43	0.125	3.18	0.225	5.72	POLYBAGS	-	NO	
10074747-XYH	0.850	21.59	0.520	13.21	0.230	5.84	POLYBAGS	-	NO	



FCconnect.com

Copyright FCJ

mat'l. code SEE NOTES 2 & 3		surface ISO 1302	tolerance ISO 406 ISO 1101	projection 	product family BERGSTIK
lir	ecm no	dr	date	title BERGSTIK II HDR. D/R .100/2.54cc® STRAIGHT	
DD				INCH/MM	dwg no 67996
				scale 1:1	sheet 8 of 8 size A3
		dr	T.BREWBAKER 12/21/94	type Product Customer Drawing	
		engr	T.HANNA 12/21/94		
		chr	J.MURPHY 12/21/94		
		appd	T.HANNA 12/21/94		
sheet	revision				
index	sheet				

form: A3