



8ETU04  
8ETU04S  
8ETU04-1

Ultrafast Rectifier

Features

- Ultrafast Recovery Time
- Low Forward Voltage Drop
- Low Leakage Current
- 175°C Operating Junction Temperature

$t_{rr} = 60ns$
$I_{F(AV)} = 8Amp$
$V_R = 400V$

Description/ Applications

International Rectifier's FRED.. series are the state of the art Ultra fast recovery rectifiers specifically designed with optimized performance of forward voltage drop and ultra fast recovery time.



The planar structure and the platinum doped life time control, guarantee the best overall performance, ruggedness and reliability characteristics.

These devices are intended for use in the output rectification stage of SMPS, UPS, DC-DC converters as well as free-wheeling diode in low voltage inverters and chopper motor drives.

Their extremely optimized stored charge and low recovery current minimize the switching losses and reduce over dissipation in the switching element and snubbers.

Absolute Maximum Ratings

Parameters	Max	Units
$V_{RRM}$ Peak Repetitive Peak Reverse Voltage	400	V
$I_{F(AV)}$ Average Rectified Forward Current, $T_C = 155^\circ C$	8	A
$I_{FSM}$ Non Repetitive Peak Surge Current, $T_C = 25^\circ C$	100	
$I_{FRM}$ Peak Repetitive Forward Current	16	
$T_J, T_{STG}$ Operating Junction and Storage Temperatures	- 65 to 175	$^\circ C$

Case Styles		
<p>8ETU04</p>  <p>TO-220AC</p>	<p>8ETU04S</p>  <p>Base Cathode 2 1 N/C 3 Anode</p> <p>D<sup>2</sup>PAK</p>	<p>8ETU04-1</p>  <p>2 1 N/C 3 Anode</p> <p>TO-262</p>

**Electrical Characteristics @  $T_J = 25^\circ\text{C}$  (unless otherwise specified)**

Parameters	Min	Typ	Max	Units	Test Conditions
$V_{BR}, V_r$ Breakdown Voltage, Blocking Voltage	400	-	-	V	$I_R = 100\mu\text{A}$
$V_F$ Forward Voltage	-	1.19	1.3	V	$I_F = 8\text{A}$
	-	0.94	1.0	V	$I_F = 8\text{A}, T_J = 150^\circ\text{C}$
$I_R$ Reverse Leakage Current	-	0.2	10	$\mu\text{A}$	$V_R = V_R \text{ Rated}$
	-	20	500	$\mu\text{A}$	$T_J = 150^\circ\text{C}, V_R = V_R \text{ Rated}$
$C_T$ Junction Capacitance	-	14	-	pF	$V_R = 400\text{V}$
$L_S$ Series Inductance	-	8.0	-	nH	Measured lead to lead 5mm from package body

**Dynamic Recovery Characteristics @  $T_J = 25^\circ\text{C}$  (unless otherwise specified)**

Parameters	Min	Typ	Max	Units	Test Conditions
$t_{rr}$ Reverse Recovery Time	-	35	60	ns	$I_F = 1.0\text{A}, di_F/dt = 50\text{A}/\mu\text{s}, V_R = 30\text{V}$
	-	43	-		$T_J = 25^\circ\text{C}$
	-	67	-		$T_J = 125^\circ\text{C}$
$I_{RRM}$ Peak Recovery Current	-	2.8	-	A	$T_J = 25^\circ\text{C}$
	-	6.3	-		$T_J = 125^\circ\text{C}$
$Q_{rr}$ Reverse Recovery Charge	-	60	-	nC	$T_J = 25^\circ\text{C}$
	-	210	-		$T_J = 125^\circ\text{C}$

$I_F = 8\text{A}$   
 $V_R = 200\text{V}$   
 $di_F/dt = 200\text{A}/\mu\text{s}$

**Thermal - Mechanical Characteristics**

Parameters	Min	Typ	Max	Units
$R_{thJC}$ Thermal Resistance, Junction to Case	-	1.8	2	$^\circ\text{C}/\text{W}$
$R_{thJA}$ ① Thermal Resistance, Junction to Ambient	-	-	50	
$R_{thCS}$ ② Thermal Resistance, Case to Heatsink	-	0.5	-	
$W_t$ Weight	-	2.0	-	g
	-	0.07	-	(oz)
Mounting Torque	6.0	-	12	Kg-cm
	5.0	-	10	lbf.in

① Typical Socket Mount

② Mounting Surface, Flat, Smooth and Greased

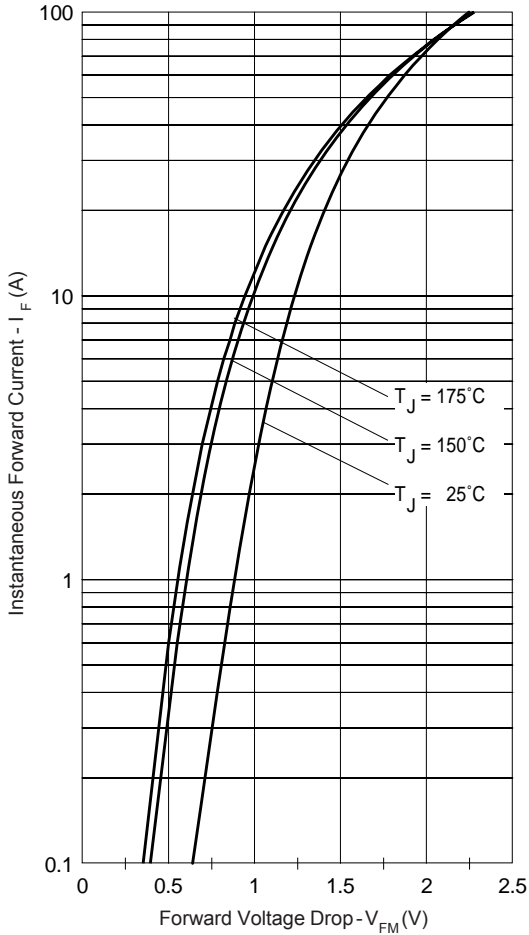

Fig. 1 - Typical Forward Voltage Drop Characteristics

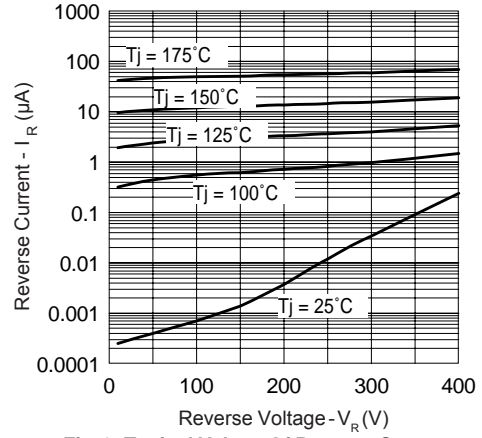

Fig. 2 - Typical Values Of Reverse Current Vs. Reverse Voltage

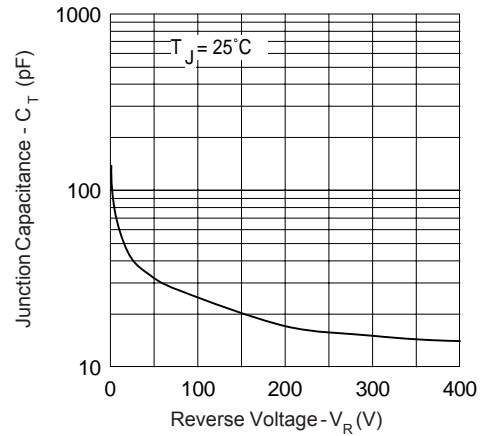

Fig. 3 - Typical Junction Capacitance Vs. Reverse Voltage

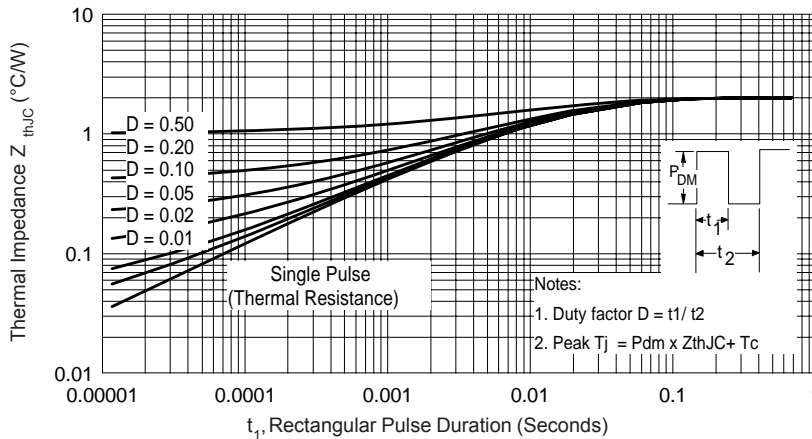
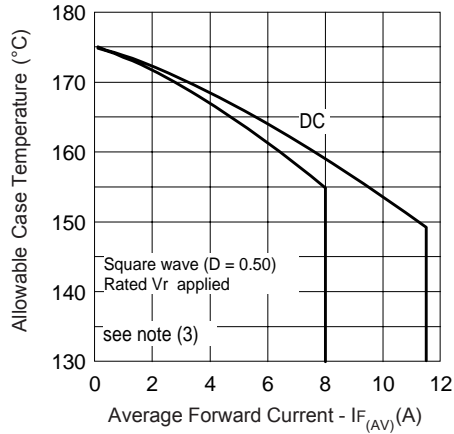
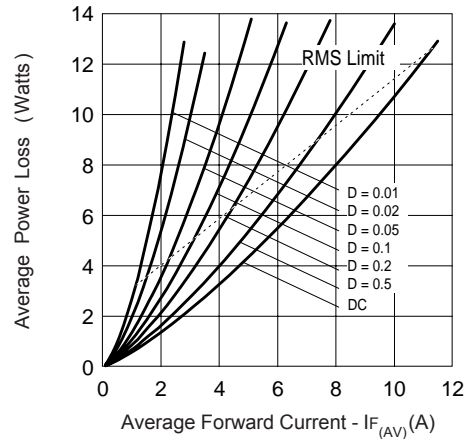

Fig. 4 - Max. Thermal Impedance  $Z_{thJC}$  Characteristics



**Fig. 5 - Max. Allowable Case Temperature Vs. Average Forward Current**



**Fig. 6 - Forward Power Loss Characteristics**

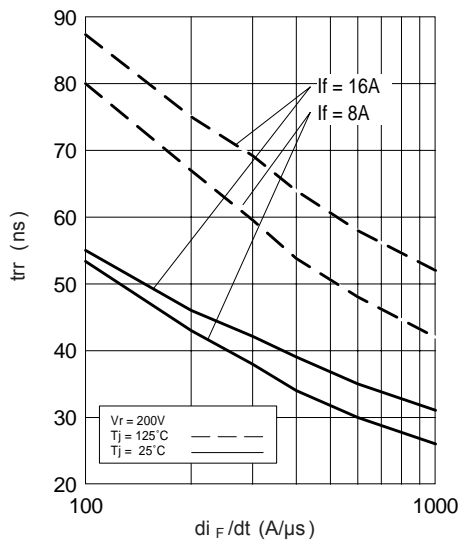

**Fig. 7 - Typical Reverse Recovery vs.  $di_F/dt$**

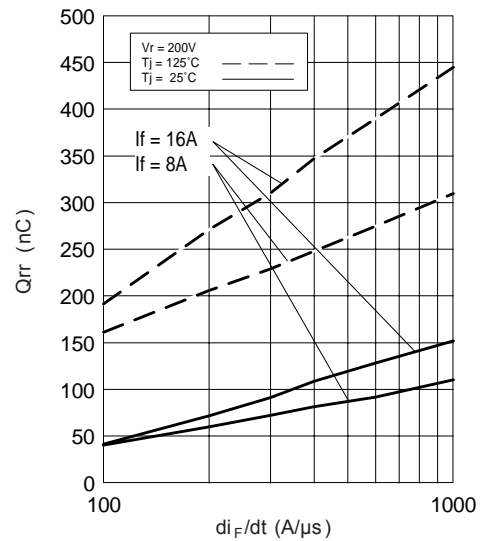

**Fig. 8 - Typical Stored Charge vs.  $di_F/dt$**

(3) Formula used:  $T_C = T_J - (P_d + P_{d_{REV}}) \times R_{thJC}$ ;  
 $P_d = \text{Forward Power Loss} = I_{F(AV)} \times V_{FM} @ (I_{F(AV)} / D)$  (see Fig. 6);  
 $P_{d_{REV}} = \text{Inverse Power Loss} = V_{R1} \times I_R (1 - D)$ ;  $I_R @ V_{R1} = \text{rated } V_R$

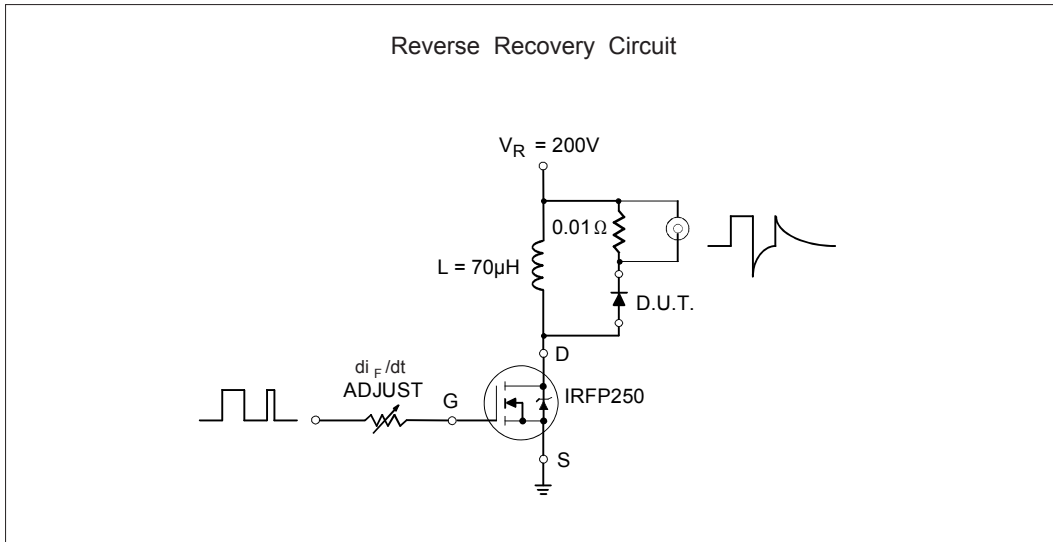

Fig. 9- Reverse Recovery Parameter Test Circuit

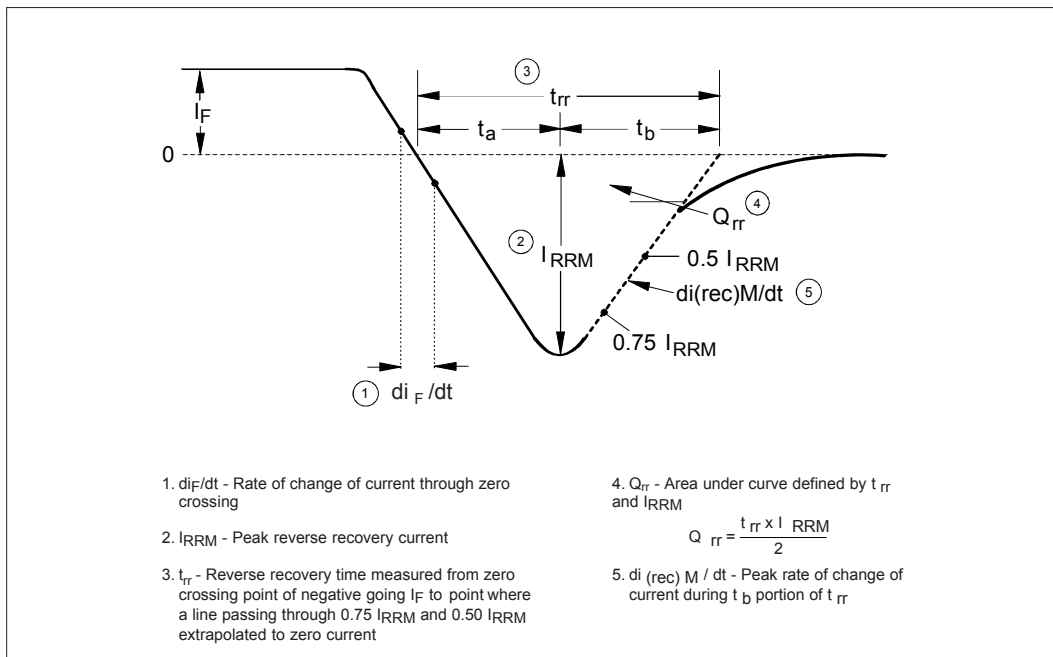

Fig. 10 - Reverse Recovery Waveform and Definitions

Outline Table

**NOTES:**

- 1.- DIMENSIONING AND TOLERANCING AS PER ASME Y14.5 M-1994.
- 2.- DIMENSIONS ARE SHOWN IN INCHES [MILLIMETERS].
- 3.- LEAD DIMENSION AND FINISH UNCONTROLLED IN L1.
- 4.- DIMENSION D, D1 & E DO NOT INCLUDE MOLD FLASH. MOLD FLASH SHALL NOT EXCEED .005" (0.127) PER SIDE. THESE DIMENSIONS ARE MEASURED AT THE OUTERMOST EXTREMES OF THE PLASTIC BODY.
- 5.- DIMENSION D1, D3 & c1 APPLY TO BASE METAL ONLY.
- 6.- CONTROLLING DIMENSION : INCHES.
- 7.- THERMAL PAD CONTOUR OPTIONAL WITHIN DIMENSIONS E, L1, D2 & E1
- 8.- DIMENSION E2 X H1 DEFINE A ZONE WHERE STAMPING AND SINGULATION IRREGULARITIES ARE ALLOWED.
- 9.- OUTLINE CONFORMS TO JEDEC TO-220, D2 (min) WHERE DIMENSIONS ARE DERIVED FROM THE ACTUAL PACKAGE OUTLINE.

SYMBOL	MILLIMETERS		INCHES		NOTES
	MIN.	MAX.	MIN.	MAX.	
A	3.56	4.83	.140	.190	
A1	0.51	1.40	.020	.055	
A2	2.03	2.92	.080	.115	
b	0.38	1.01	.015	.040	
b1	0.38	0.97	.015	.038	5
b2	1.14	1.78	.045	.070	
b3	1.14	1.73	.045	.068	5
c	0.36	0.61	.014	.024	
c1	0.36	0.56	.014	.022	5
D	14.22	16.51	.560	.650	4
D1	8.38	9.02	.330	.355	
D2	11.68	12.88	.460	.507	7
E	9.65	10.67	.380	.420	4,7
E1	6.86	8.89	.270	.350	7
E2	-	0.76	-	.030	8
e	2.54 BSC		.100 BSC		
e1	4.18 BSC		.165 BSC		
H1	5.84	6.86	.230	.270	7,8
L	12.70	14.73	.500	.580	
L1	-	6.35	-	.250	3
L3	1.78	2.13	.070	.084	
L4	0.76	1.27	.030	.050	3
wP	3.53	3.73	.139	.147	
Q	2.54	3.05	.100	.120	

**LEAD ASSIGNMENTS**

DIODES  
 1-2- CATHODE  
 3- ANODE

**Conforms to JEDEC Outline TO-220AC**  
 Dimensions in millimeters and (inches)

**NOTES:**

1. DIMENSIONING AND TOLERANCING PER ASME Y14.5M-1994
2. DIMENSIONS ARE SHOWN IN MILLIMETERS [INCHES]
3. DIMENSION D & E DO NOT INCLUDE MOLD FLASH. MOLD FLASH SHALL NOT EXCEED .0127 (.005") PER SIDE. THESE DIMENSIONS ARE MEASURED AT THE OUTERMOST EXTREMES OF THE PLASTIC BODY AT DATUM H.
4. THERMAL PAD CONTOUR OPTIONAL WITHIN DIMENSION E, L1, D1 & E1.
5. DIMENSION b1 AND c1 APPLY TO BASE METAL ONLY.
6. DATUM A & B TO BE DETERMINED AT DATUM PLANE H.
7. CONTROLLING DIMENSION: MM.
8. OUTLINE CONFORMS TO JEDEC OUTLINE TO-263AR.

SYMBOL	MILLIMETERS		INCHES		NOTES
	MIN.	MAX.	MIN.	MAX.	
A	4.06	4.83	.160	.190	
A1	0.00	0.254	.000	.010	
b	0.51	0.99	.020	.039	
b1	0.51	0.89	.020	.035	5
b2	1.14	1.78	.045	.070	
b3	1.14	1.73	.045	.068	5
c	0.38	0.74	.015	.029	
c1	0.38	0.58	.015	.023	5
c2	1.14	1.65	.045	.065	
D	8.38	9.65	.330	.380	3
D1	6.86	-	.270	-	4
E	9.65	10.67	.380	.420	3,4
E1	6.22	-	.245	-	4
e	2.54 BSC		.100 BSC		
H	14.81	15.88	.578	.620	
L	1.78	2.79	.070	.110	
L1	-	1.65	-	.066	4
L2	1.27	1.78	-	.070	
L3	0.76	-	.030	-	
L4	4.78	5.20	.188	.208	

**LEAD ASSIGNMENTS**

DIODES  
 1- ANODE (TWO DIE) / OPEN (ONE DIE)  
 2- CATHODE  
 3- ANODE

**Conforms to JEDEC Outline D<sup>2</sup>PAK**  
 Dimensions in millimeters and (inches)

Outline Table

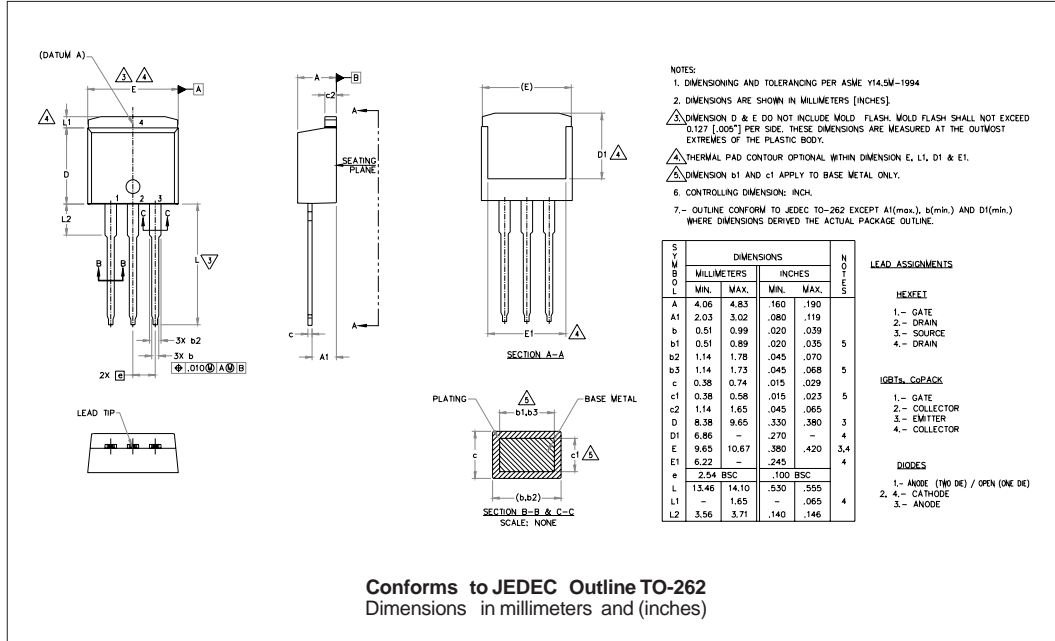

Tape & Reel Information

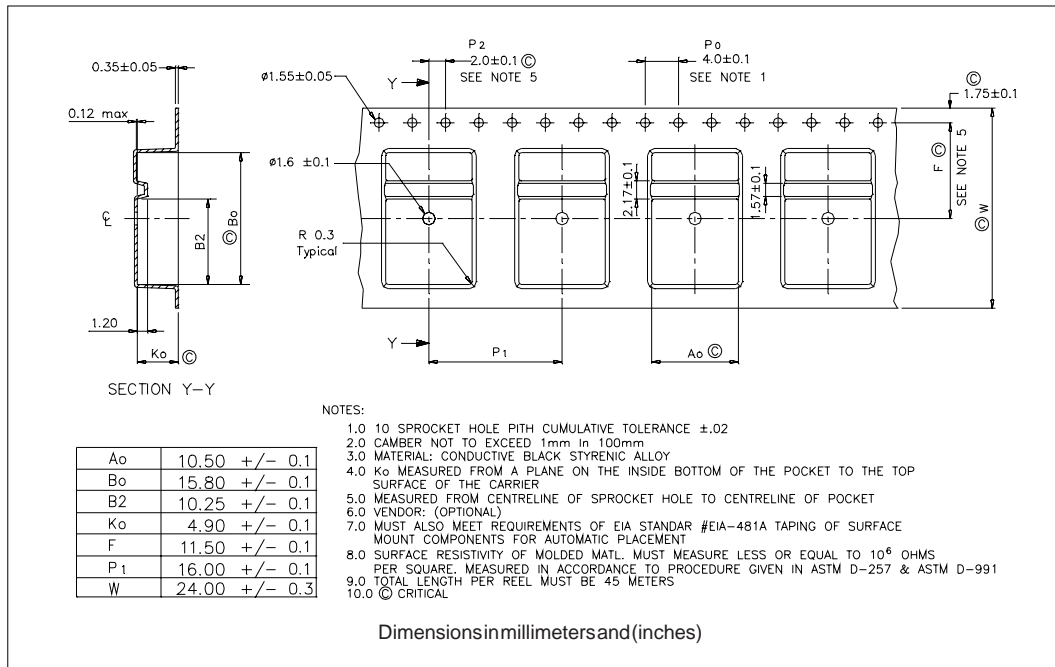

Part Marking Information

<p>TO-220AB</p>	<p>EXAMPLE: THIS IS A 8ETU04 LOT CODE 1789 ASSEMBLED ON WW 19, 2001 IN THE ASSEMBLY LINE "C"</p>	<p>INTERNATIONAL RECTIFIER LOGO</p> <p>ASSEMBLY LOT CODE</p> <p>PART NUMBER</p> <p>DATE CODE</p> <p>YEAR 1 = 2001 WEEK 19 LINE C</p>
<p>D<sup>2</sup>PAK</p>	<p>EXAMPLE: THIS IS A 8ETU04S LOT CODE 8024 ASSEMBLED ON WW 02, 2000 IN THE ASSEMBLY LINE "L"</p>	<p>INTERNATIONAL RECTIFIER LOGO</p> <p>ASSEMBLY LOT CODE</p> <p>PART NUMBER</p> <p>DATE CODE</p> <p>YEAR 0 = 2000 WEEK 02 LINE L</p>
<p>TO-262</p>	<p>EXAMPLE: THIS IS A 8ETU04-1 LOT CODE 1789 ASSEMBLED ON WW 19, 1999 IN THE ASSEMBLY LINE "C"</p>	<p>INTERNATIONAL RECTIFIER LOGO</p> <p>ASSEMBLY LOT CODE</p> <p>PART NUMBER</p> <p>DATE CODE</p> <p>YEAR 9 = 1999 WEEK 19 LINE C</p>



Ordering Information Table

Device Code																	
	<table border="1" style="margin-left: auto; margin-right: auto;"> <tr> <td style="padding: 5px;">8</td> <td style="padding: 5px;">E</td> <td style="padding: 5px;">T</td> <td style="padding: 5px;">U</td> <td style="padding: 5px;">04</td> <td style="padding: 5px;">-1</td> <td style="padding: 5px;">TRL</td> <td style="padding: 5px;">-</td> </tr> <tr> <td style="text-align: center;">①</td> <td style="text-align: center;">②</td> <td style="text-align: center;">③</td> <td style="text-align: center;">④</td> <td style="text-align: center;">⑤</td> <td style="text-align: center;">⑥</td> <td style="text-align: center;">⑦</td> <td style="text-align: center;">⑧</td> </tr> </table>	8	E	T	U	04	-1	TRL	-	①	②	③	④	⑤	⑥	⑦	⑧
8	E	T	U	04	-1	TRL	-										
①	②	③	④	⑤	⑥	⑦	⑧										
<b>1</b>	- Current Rating (8 = 8A)																
<b>2</b>	- E = Single Diode																
<b>3</b>	- T = TO-220																
<b>4</b>	- U = Ultrafast Recovery																
<b>5</b>	- Voltage Rating (04 = 400V)																
<b>6</b>	- None = TO-220AB S = D <sup>2</sup> Pak -1 = TO-262 Option																
<b>7</b>	- None = Tube (50 pieces) TRL = Tape & Reel (Left Oriented - for D <sup>2</sup> Pak only) TRR = Tape & Reel (Right Oriented - for D <sup>2</sup> Pak only)																
<b>8</b>	- • none = Standard Production • PbF = Lead-Free																

Data and specifications subject to change without notice.  
 This product has been designed and qualified for Industrial Level.  
 Qualification Standards can be found on IR's Web site.



## Notice

The products described herein were acquired by Vishay Intertechnology, Inc., as part of its acquisition of International Rectifier's Power Control Systems (PCS) business, which closed in April 2007. Specifications of the products displayed herein are pending review by Vishay and are subject to the terms and conditions shown below.

Specifications of the products displayed herein are subject to change without notice. Vishay Intertechnology, Inc., or anyone on its behalf, assumes no responsibility or liability for any errors or inaccuracies.

Information contained herein is intended to provide a product description only. No license, express or implied, by estoppel or otherwise, to any intellectual property rights is granted by this document. Except as provided in Vishay's terms and conditions of sale for such products, Vishay assumes no liability whatsoever, and disclaims any express or implied warranty, relating to sale and/or use of Vishay products including liability or warranties relating to fitness for a particular purpose, merchantability, or infringement of any patent, copyright, or other intellectual property right.

The products shown herein are not designed for use in medical, life-saving, or life-sustaining applications. Customers using or selling these products for use in such applications do so at their own risk and agree to fully indemnify Vishay for any damages resulting from such improper use or sale.

International Rectifier®, IR®, the IR logo, HEXFET®, HEXSense®, HEXDIP®, DOL®, INTERO®, and POWIRTRAIN® are registered trademarks of International Rectifier Corporation in the U.S. and other countries. All other product names noted herein may be trademarks of their respective owners.