



8ETX06
8ETX06S
8ETX06-1
8ETX06FP

Hyperfast Rectifier

Features

- Hyperfast Recovery Time
- Low Forward Voltage Drop
- Low Leakage Current
- 175°C Operating Junction Temperature
- UL E78996 approved 

$t_{rr} = 15\text{ns typ.}$
 $I_{F(AV)} = 8\text{Amp}$
 $V_R = 600\text{V}$

Description/ Applications

State of the art Hyperfast recovery rectifiers designed with optimized performance of forward voltage drop, Hyperfast recover time, and soft recovery.





The planar structure and the platinum doped life time control guarantee the best overall performance, ruggedness and reliability characteristics.

These devices are intended for use in PFC Boost stage in the AC-DC section of SMPS, inverters or as freewheeling diodes.

The IR extremely optimized stored charge and low recovery current minimize the switching losses and reduce over dissipation in the switching element and snubbers.

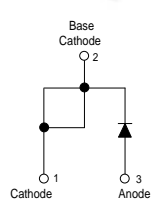
Absolute Maximum Ratings

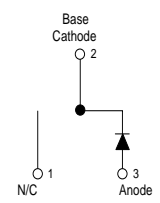
Parameters	Max	Units
V_{RRM} Peak Repetitive Reverse Voltage	600	V
$I_{F(AV)}$ Average Rectified Forward Current @ $T_C = 143^\circ\text{C}$ @ $T_C = 106^\circ\text{C}$ (FULLPACK)	8	A
I_{FSM} Non Repetitive Peak Surge Current @ $T_J = 25^\circ\text{C}$	110	
I_{FM} Peak Repetitive Forward Current	18	
T_J, T_{STG} Operating Junction and Storage Temperatures	- 65 to 175	$^\circ\text{C}$

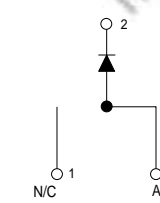
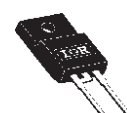
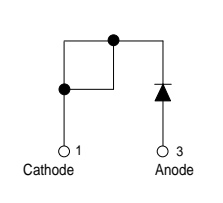
Case Styles			
  TO-220AC	  D²PAK	  TO-262	  TO-220 FULLPACK

Electrical Characteristics @ T_J = 25°C (unless otherwise specified)

Parameters	Min	Typ	Max	Units	Test Conditions
V _{BR} , V _F	600	-	-	V	I _R = 100μA
V _F	-	2.3	3.0	V	I _F = 8A, T _J = 25°C
	-	1.4	1.7	V	I _F = 8A, T _J = 150°C
I _R	-	0.3	50	μA	V _R = V _R Rated
	-	35	500	μA	T _J = 150°C, V _R = V _R Rated
C _T	-	17	-	pF	V _R = 600V
L _S	-	8.0	-	nH	Measured lead to lead 5mm from package body

Dynamic Recovery Characteristics @ T_C = 25°C (unless otherwise specified)

Parameters	Min	Typ	Max	Units	Test Conditions	
t _{rr}	-	15	19	ns	I _F = 1A, di _F /dt = 100A/μs, V _R = 30V	
	-	16	24		I _F = 8A, di _F /dt = 100A/μs, V _R = 30V	
	-	17	-		T _J = 25°C	
	-	40	-		T _J = 125°C	
I _R RRM	-	2.3	-	A	T _J = 25°C	
	-	4.5	-		T _J = 125°C	
Q _{rr}	-	20	-	nC	T _J = 25°C	
	-	100	-		T _J = 125°C	
t _{rr}	-	31	-	ns	I _F = 8A di _F /dt = 200A/μs V _R = 390V	
I _R RRM	-	12	-			T _J = 125°C
Q _{rr}	-	195	-			nC

Thermal - Mechanical Characteristics

Parameters	Min	Typ	Max	Units
T _J	-	-	175	°C
T _{Stg}	-65	-	175	°C
R _{thJC}	-	1.4	2	°C/W
	-	3.4	4.3	
R _{thJA} ①	-	-	70	°C/W
R _{thCS} ②	-	0.5	-	°C/W
Weight	-	2.0	-	g
	-	0.07	-	(oz)
Mounting Torque	6.0	-	12	Kg-cm
	5.0	-	10	lbf.in

① Typical Socket Mount

② Mounting Surface, Flat, Smooth and Greased

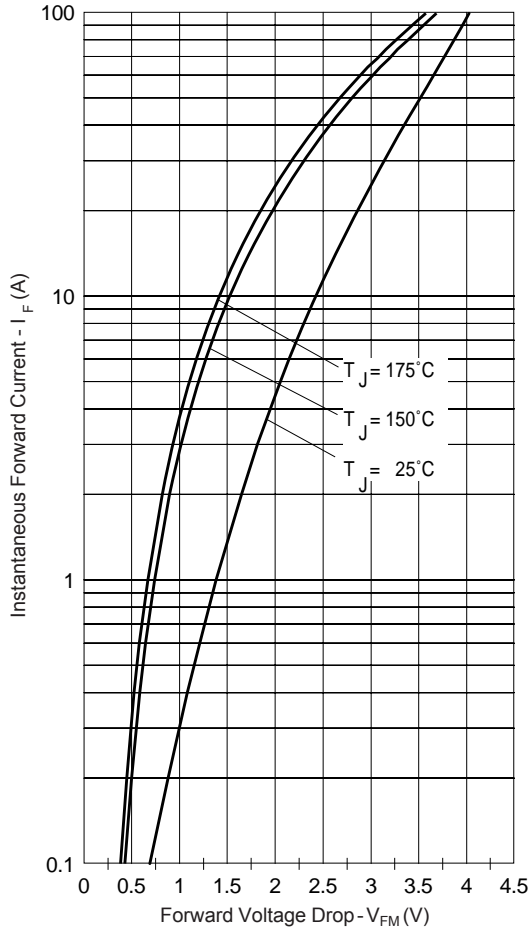

Fig. 1 - Typical Forward Voltage Drop Characteristics

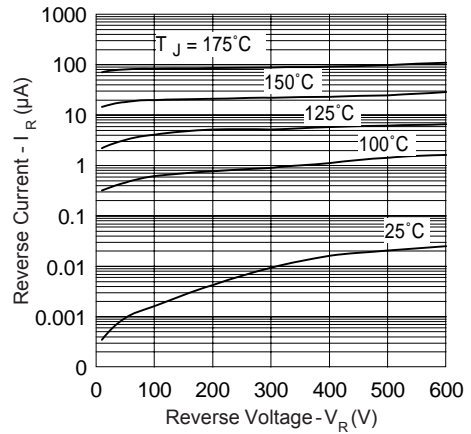

Fig. 2 - Typical Values Of Reverse Current Vs. Reverse Voltage

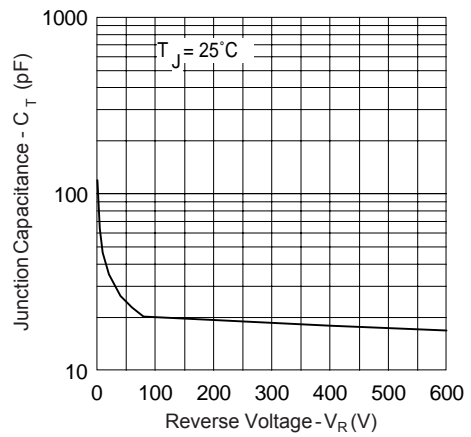

Fig. 3 - Typical Junction Capacitance Vs. Reverse Voltage

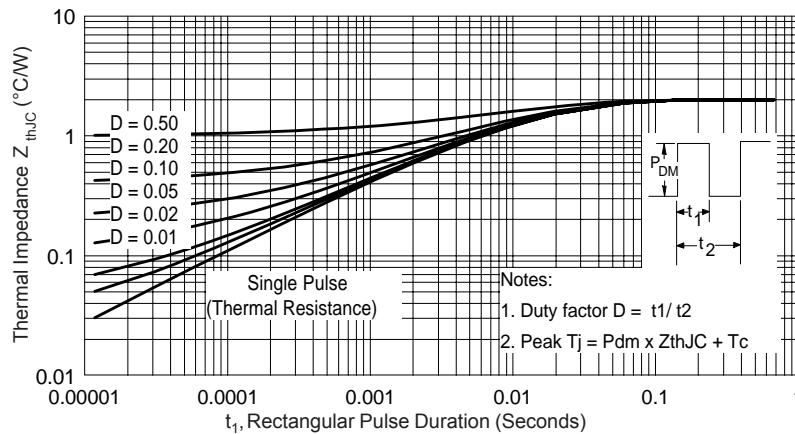

Fig. 4 - Max. Thermal Impedance Z_{thJC} Characteristics

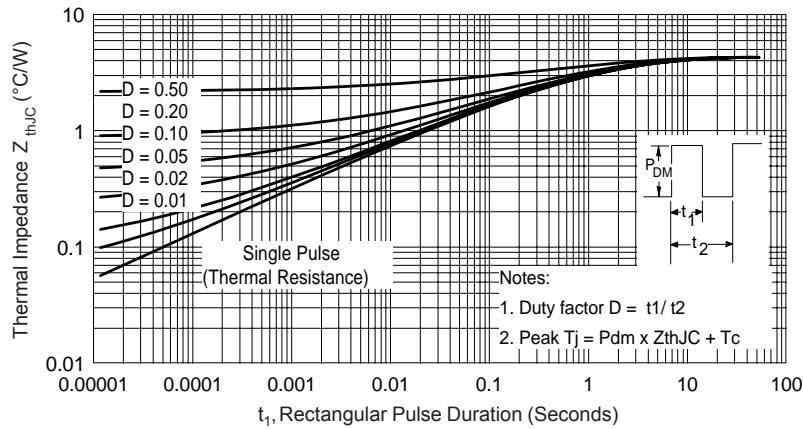

Fig. 5 - Max. Thermal Impedance Z_{thJC} Characteristics (FULLPACK)

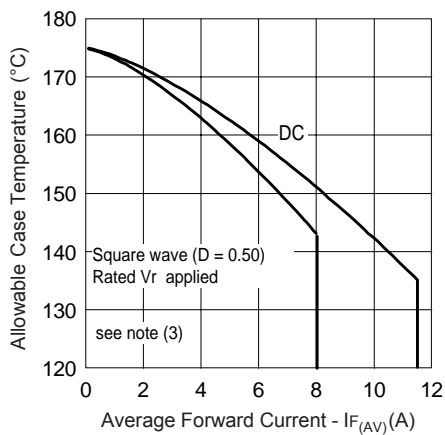

Fig. 6 - Max. Allowable Case Temperature Vs. Average Forward Current

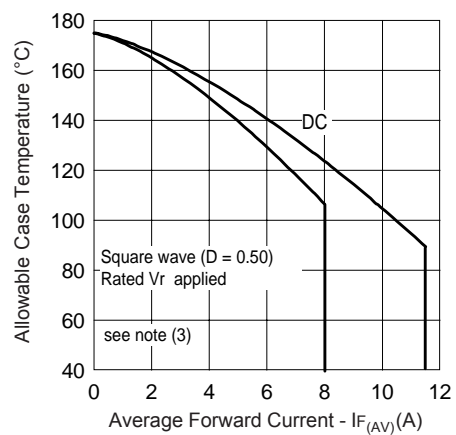

Fig. 7 - Max. Allowable Case Temperature Vs. Average Forward Current (FULLPACK)

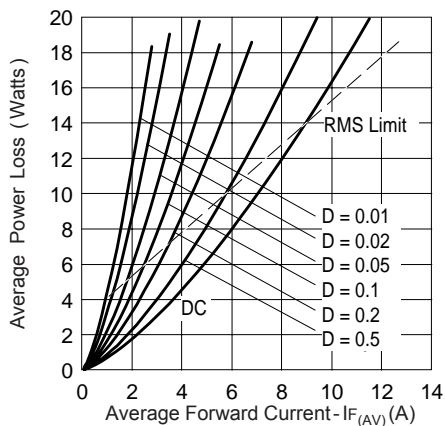

Fig. 8 - Forward Power Loss Characteristics

(3) Formula used: $T_c = T_j - (P_d + P_{d_{REV}}) \times R_{thJC}$;
 P_d = Forward Power Loss =
 $I_{F(AV)} \times V_{FM} @ (I_{F(AV)}/D)$
 (see Fig. 8);
 $P_{d_{REV}}$ = Inverse Power Loss = $V_{R1} \times I_R (1 - D)$;
 $I_R @ V_{R1}$ = rated V_R

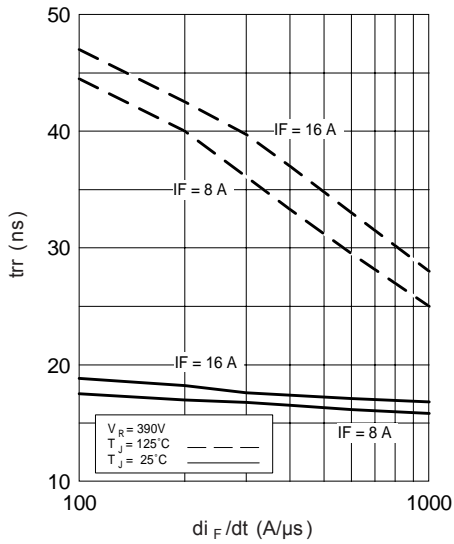

Fig.9- Typical Reverse Recovery vs. di_F/dt

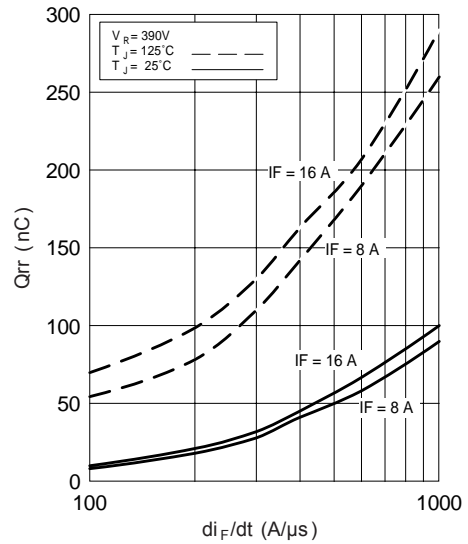

Fig.10- Typical Stored Charge vs. di_F/dt

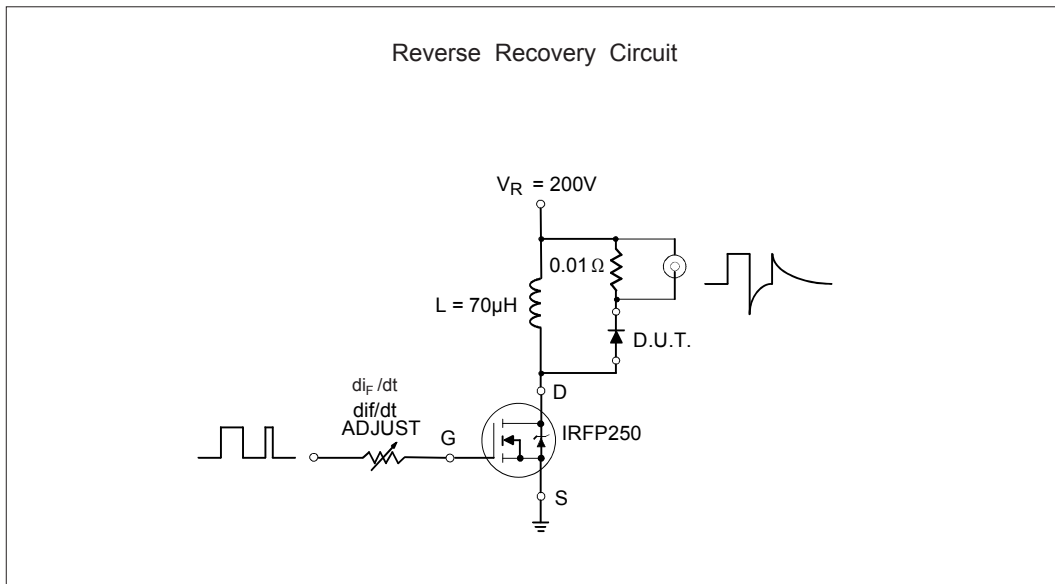

Fig.11- Reverse Recovery Parameter Test Circuit

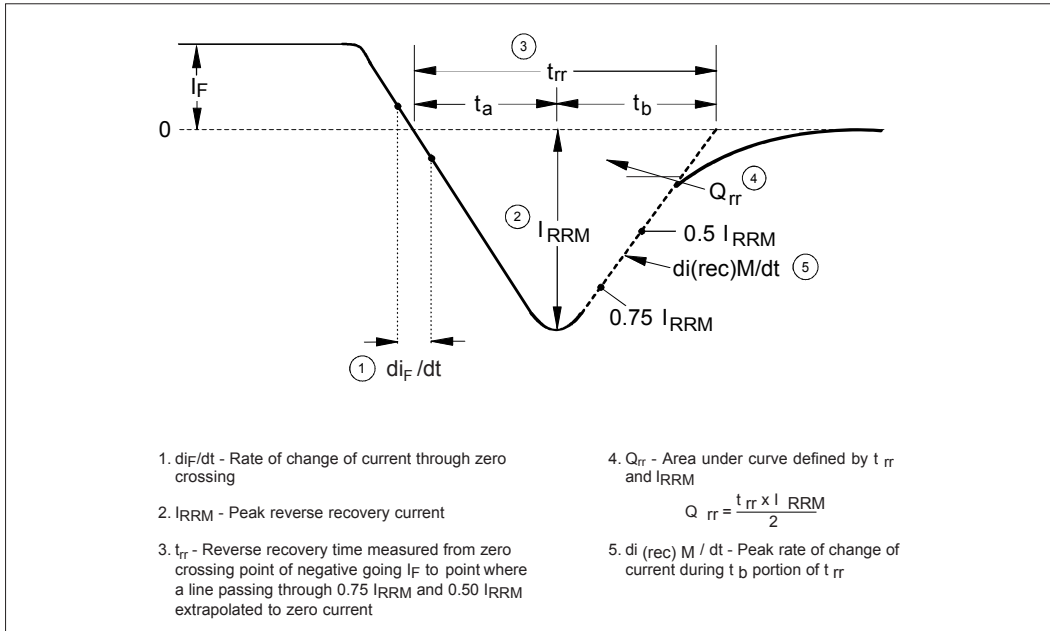
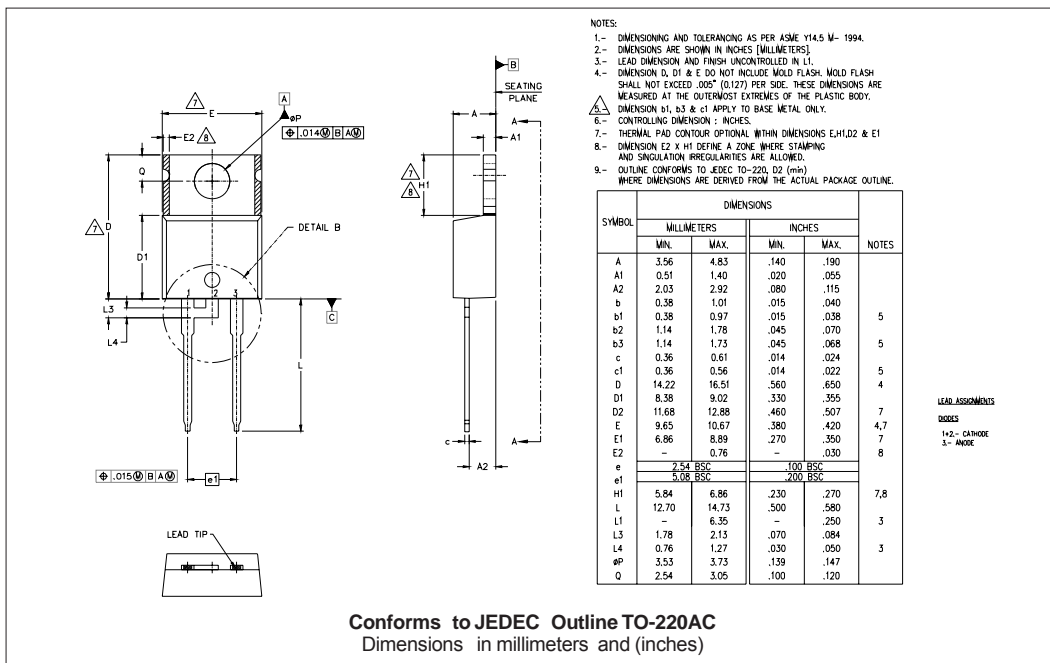
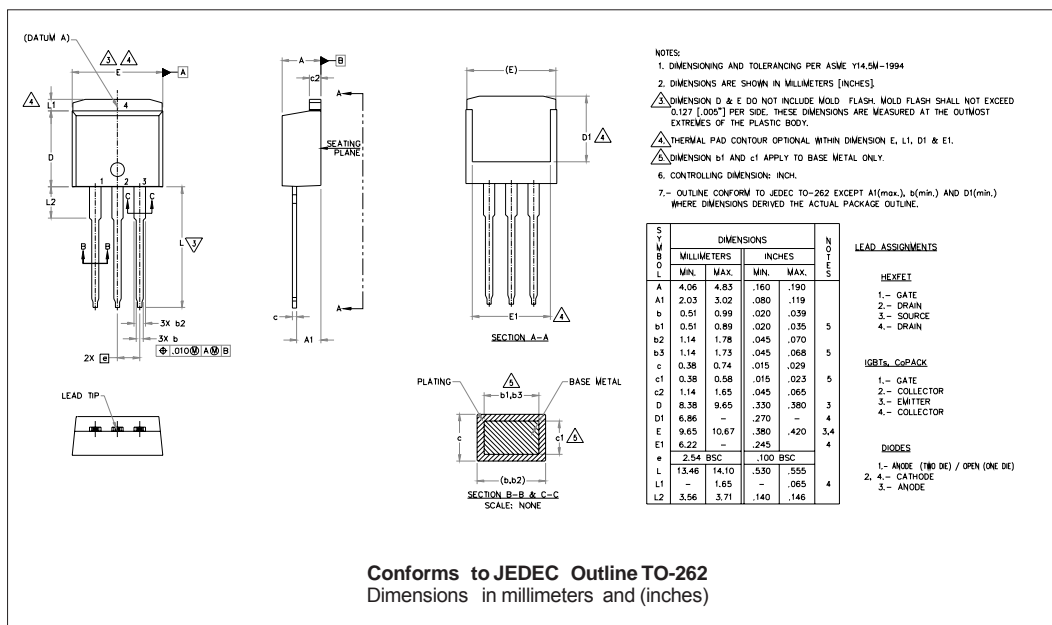
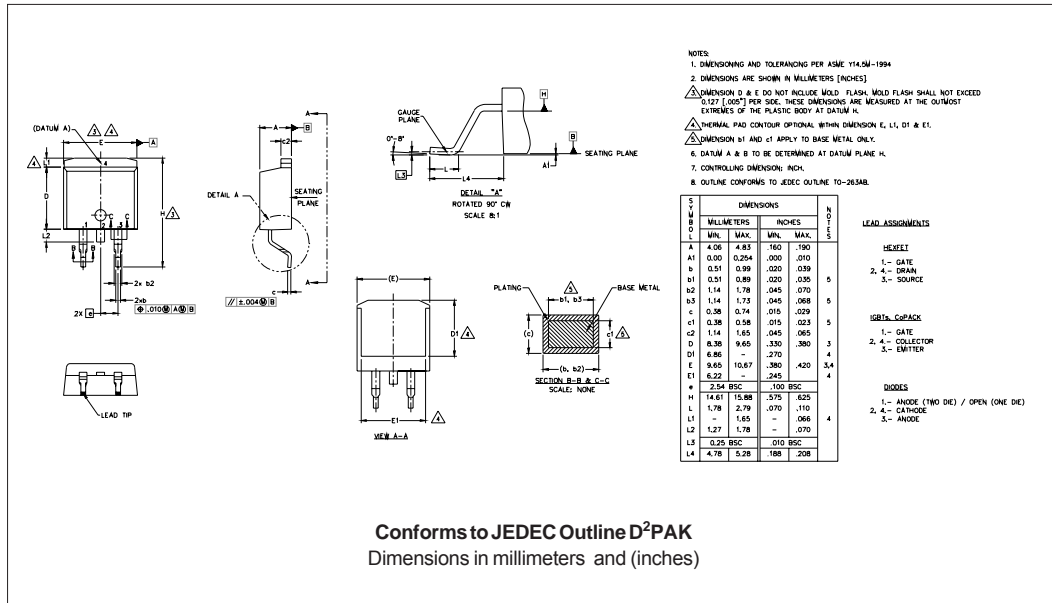

Fig. 12 - Reverse Recovery Waveform and Definitions

Outline Table



Outline Table



Outline Table

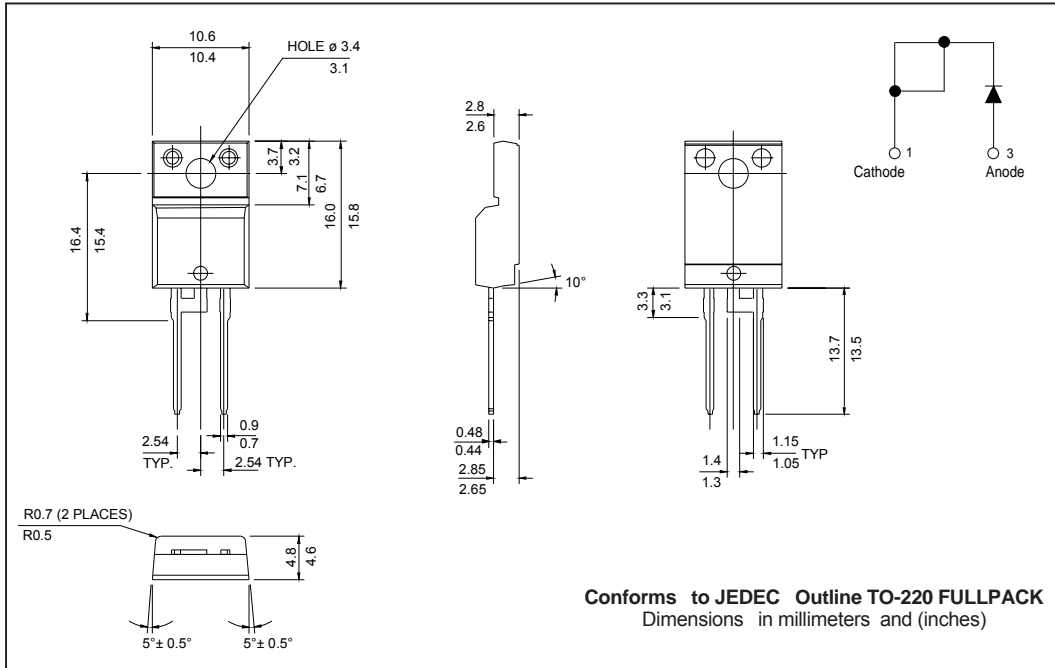

Tape & Reel Information

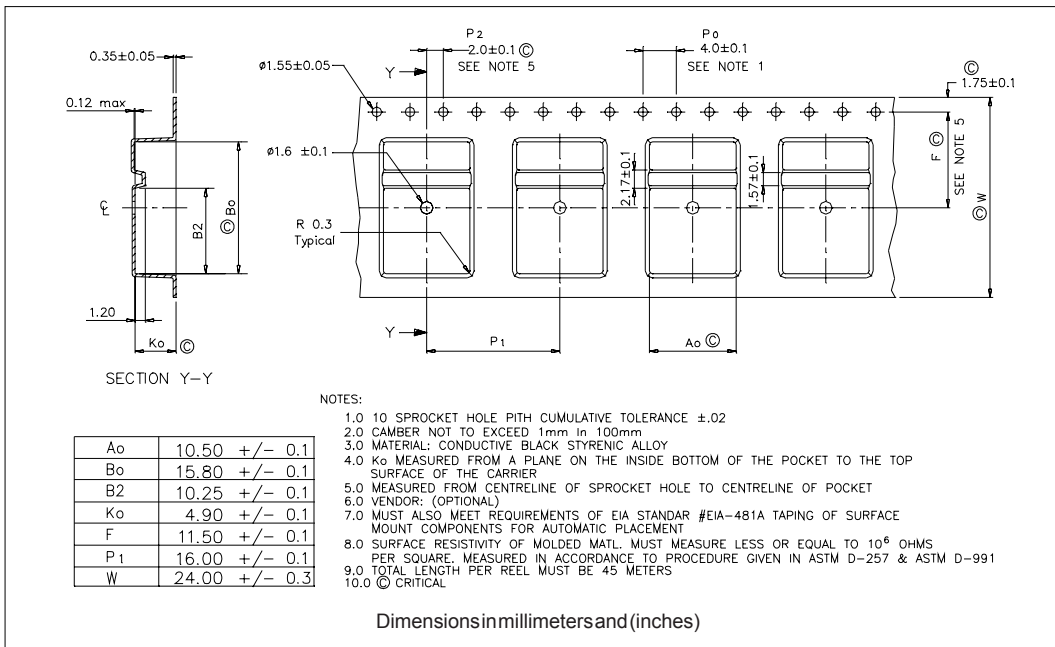

Part Marking Information

<p>TO-220AC</p>	<p>EXAMPLE: THIS IS A 8ETX06 LOT CODE 1789 ASSEMBLED ON WW 19, 2001 IN THE ASSEMBLY LINE "C"</p>	<p>INTERNATIONAL RECTIFIER LOGO</p> <p>ASSEMBLY LOT CODE</p> <p>PART NUMBER</p> <p>DATE CODE YEAR 1 = 2001 WEEK 19 LINE C</p>
<p>D²PAK</p>	<p>EXAMPLE: THIS IS A 8ETX06S LOT CODE 8024 ASSEMBLED ON WW 02, 2000 IN THE ASSEMBLY LINE "L"</p>	<p>INTERNATIONAL RECTIFIER LOGO</p> <p>ASSEMBLY LOT CODE</p> <p>PART NUMBER</p> <p>DATE CODE YEAR 0 = 2000 WEEK 02 LINE L</p>
<p>TO-262</p>	<p>EXAMPLE: THIS IS A 8ETX06-1 LOT CODE 1789 ASSEMBLED ON WW 19, 1999 IN THE ASSEMBLY LINE "C"</p>	<p>INTERNATIONAL RECTIFIER LOGO</p> <p>ASSEMBLY LOT CODE</p> <p>PART NUMBER</p> <p>DATE CODE YEAR 9 = 1999 WEEK 19 LINE C</p>
<p>FULLPACK</p>	<p>EXAMPLE: THIS IS A 8ETX06FP LOT CODE 1789 ASSEMBLED ON WW 19, 2000 IN THE ASSEMBLY LINE "C"</p>	<p>INTERNATIONAL RECTIFIER LOGO</p> <p>ASSEMBLY LOT CODE</p> <p>PART NUMBER</p> <p>DATE CODE YEAR 0 = 2000 WEEK 19 LINE C</p>

Ordering Information Table

Device Code							
8	E	T	X	06	-1	TRL	-
①	②	③	④	⑤	⑥	⑦	⑧
1	- Current Rating (8 = 8A)						
2	- E = Single Diode						
3	- T = TO-220						
4	- X = HyperFast Recovery						
5	- Voltage Rating (06 = 600V)						
6	- None = TO-220 S = D ² Pak -1 = TO-262 Option FP = TO-220 FULLPACK						
7	- None = Tube (50 pieces) TRL = Tape & Reel (Left Oriented - for D ² Pak only) TRR = Tape & Reel (Right Oriented - for D ² Pak only)						
8	- • none = Standard Production • PbF = Lead-Free						

Data and specifications subject to change without notice.
 This product has been designed and qualified for Industrial Level.
 Qualification Standards can be found on IR's Web site.



Notice

The products described herein were acquired by Vishay Intertechnology, Inc., as part of its acquisition of International Rectifier's Power Control Systems (PCS) business, which closed in April 2007. Specifications of the products displayed herein are pending review by Vishay and are subject to the terms and conditions shown below.

Specifications of the products displayed herein are subject to change without notice. Vishay Intertechnology, Inc., or anyone on its behalf, assumes no responsibility or liability for any errors or inaccuracies.

Information contained herein is intended to provide a product description only. No license, express or implied, by estoppel or otherwise, to any intellectual property rights is granted by this document. Except as provided in Vishay's terms and conditions of sale for such products, Vishay assumes no liability whatsoever, and disclaims any express or implied warranty, relating to sale and/or use of Vishay products including liability or warranties relating to fitness for a particular purpose, merchantability, or infringement of any patent, copyright, or other intellectual property right.

The products shown herein are not designed for use in medical, life-saving, or life-sustaining applications. Customers using or selling these products for use in such applications do so at their own risk and agree to fully indemnify Vishay for any damages resulting from such improper use or sale.

International Rectifier®, IR®, the IR logo, HEXFET®, HEXSense®, HEXDIP®, DOL®, INTERO®, and POWIRTRAIN® are registered trademarks of International Rectifier Corporation in the U.S. and other countries. All other product names noted herein may be trademarks of their respective owners.