

TYPE A

NOTE:
 MATERIAL:
 HOUSING: THERMOPLASTIC (PBT)
 COLOR: WHITE/BLACK
 CONTACT: BRASS
 SHELL: SPCC
 PLATING:
 CONTACT PLATING CORD: 1u"/30u"
 SHELL: NICKEL PLATING
 SPECIFICATION:
 VOLTAGE RATING: 30V
 CURRENT RATING: 1A
 CONTACT RESISTANCE TERMINAL: 30mΩ MAX
 DIELECTRIC WITHSTANDING VOLTAGE: 750V AC
 INSULATION RESISTANCE: 1000MΩ MIN

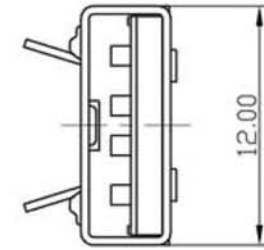
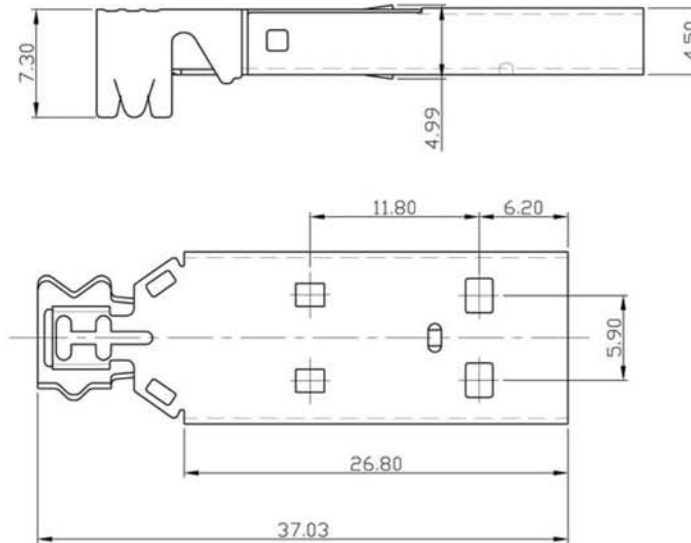

TYPE B

Notes:

- 1.0 Rating:
 - 1.1 Voltage: 30 VACS (R.M.S)
 - 1.2 Current: 1.5 Ampere minimum per contact at 30°C T-Rise
 - 1.3 Temperature: -55°C to +85°C unless limited by cable or Overmold (-40°C to +60°C storage; 0°C to +40°C Operating)
- 2.0 Electric Characteristic
 - 2.1 Contact Resistance: 30 Milliohms Maximum Initial
 - 2.2 Insulation Resistance: 1,000 Megohms Minimum
 - 2.3 Dielectric Withstanding Voltage: 500 Vac at Sea Level
 - 2.4 Capacitance: 2 Picofarads Maximum at 1KHZ
- 3.0 Materials:
 - 3.1 Front & Back Shells: Steel
 - 3.2 Housing: Thermoplastic, Glass Filled, UL 94V-0 Rated
 - 3.3 Contact: Copper Alloy
- 4.0 Finishes:
 - 4.1 Front & Shell:
 - TIN/Lead: 5.0um Min Bright Tin/Lead(9:1) Over 2.5um min Copper. Nickel: 3.0um-5.0um Nickel over 2.5um min Copper
 - Gold: 1.5u" min Gold; 5.0um min Nickel; 2.5um min Copper
 - 4.2 Contact: Selective Gold Plating
- 5.0 Others:
 - 5.1 Recommended Cable Application: Outer Diameter Applicable Range: $\varnothing 3.4\text{mm}$ to $\varnothing 5.3\text{mm}$
 - 5.2 All parts packaged unassembled

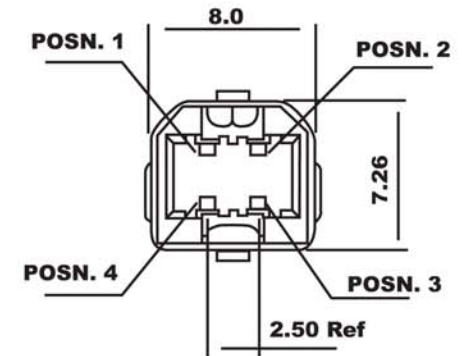
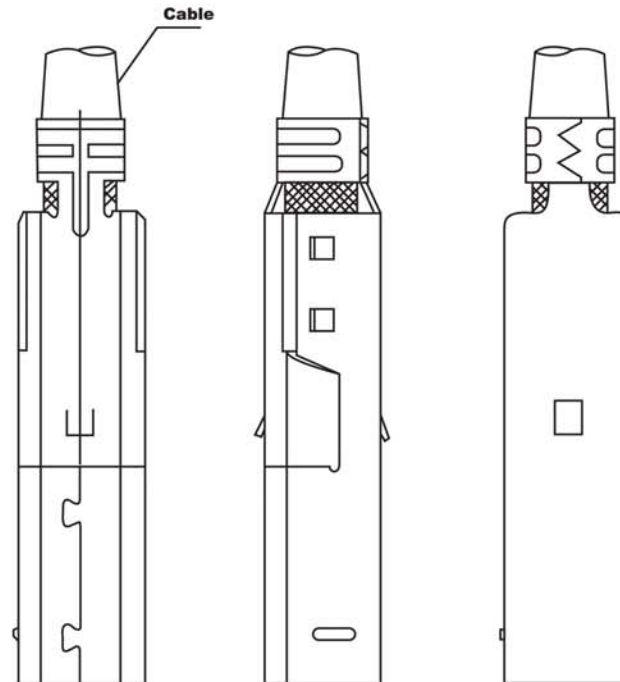

RoHS
Compliant

ITEM NO

A-USBPA-R (Type A, V1.1) A-USBPB-R (Type B, V1.1)
 A-USBPA/2-R (Type A, V2.0) A-USBPB-R (Type B, V2.0)

TITLE

USB A + B, Assembly-Type, Version 1.1 & 2.0

ASSMANN
Electronics, Inc.

1840 W. Drake Drive, Suite 101 - Tempe, AZ 85283
 Toll Free: 1-877-277-6266 Email: info@usa-assmann.com

THIS DRAWING IS UNPUBLISHED
 © Copyright 2008 by Assmann Electronic Components
 All International Rights Reserved

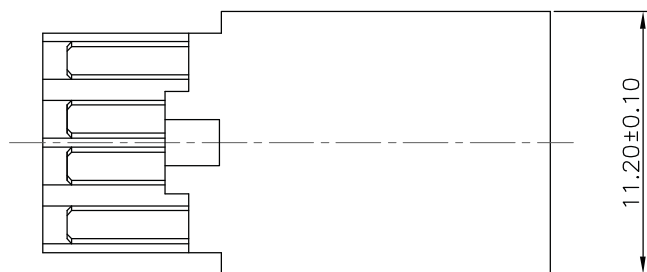
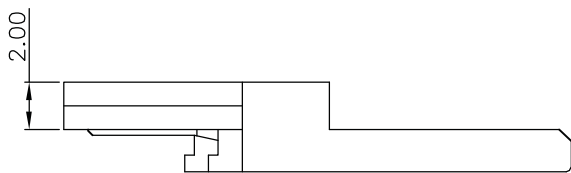
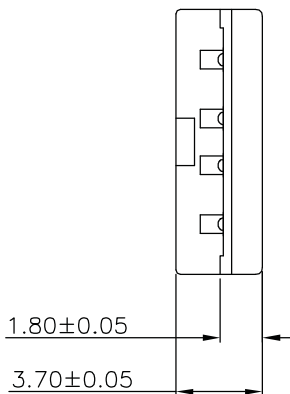
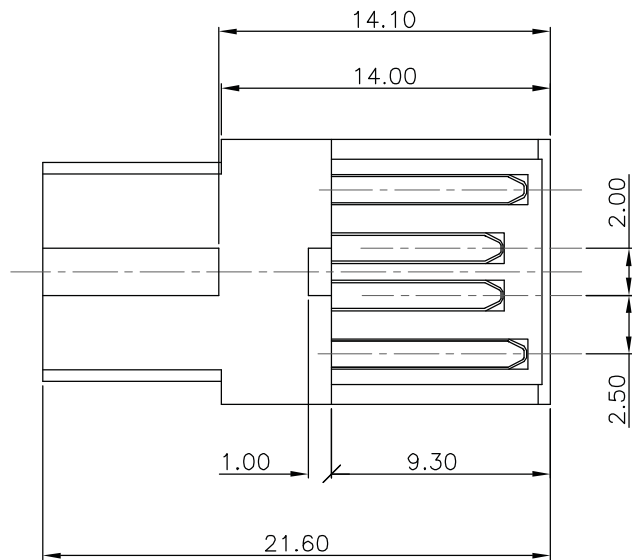

Material:

- Housing: PBT+30%GF
- Contact: Brass (C2680R-H) T=0.2
- Contact Finish: Gold plating $1\mu''$

Ⓜ = Assmann logo



ITEM NO.
TITLE

ASSMANN
Electronics, Inc.

1840 W. Drake Drive, Suite 101 • Tempe, AZ 85283
Toll Free: 1-877-277-6266 • Email: info@usa-assmann.com

THIS DRAWING IS UNPUBLISHED
©Copyright 2010 by Assmann Electronic Components
All International Rights Reserved