

### Phase Control SCR 680 Amperes Avg 500-1300 Volts

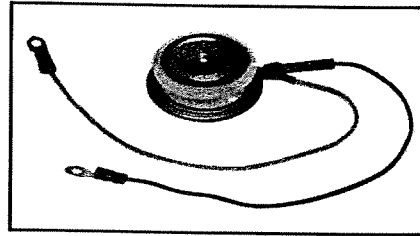
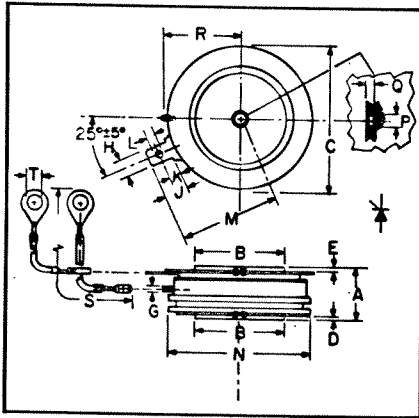

**C430**  
**Phase Control SCR**  
 680 Amperes/500-1300 Volts

**C430**  
**Outline Drawing**

Dimensions	Inches		Millimeters	
	Min.	Max.	Min.	Max.
A	.560	.605	14.22	15.37
B	.985	.995	25.01	25.27
C	1.600	1.650	40.64	41.91
D	.030	—	.76	—
E	.040	—	1.01	—
G	.057	.059	1.44	1.50
H	.186	.191	4.72	4.85
J	.245	.255	6.22	6.48
K	.115	.130	2.92	3.30
L	.064	.070	1.62	1.78
M	—	1.120	—	28.45
N	—	1.585	—	40.26
P	.135	.145	3.42	3.68
Q	.070	.084	1.77	2.13
R	—	.875	—	22.23
S	12.219	12.343	310.36	313.51
T	.137	.153	3.47	3.89

**Description**

Powerex Silicon Controlled Rectifiers (SCR) are designed for phase control applications. These are all-diffused, Press-Pak (Pow-R-Disc) devices employing the field-proven amplifying (di/namic) gate.

**Features:**

- Low On-State Voltage
- High di/dt
- High dv/dt
- Hermetic Packaging
- Excellent Surge and I<sup>2</sup>t Ratings

**Applications:**

- Power Supplies
- Battery Chargers
- Motor Control
- Light Dimmers
- VAR Generators

**Ordering Information**

Example: Select the complete five or six digit part number you desire from the table - i.e. C430PB is a 1200 Volt, 680 Ampere Phase Control SCR.

Type	Voltage		Current
	V <sub>DRM</sub> V <sub>RRM</sub>	Code	
C430	500	E	680
	600	M	
	700	S	
	800	N	
	900	T	
	1000	P	
	1100	PA	
	1200	PB	
	1300	PC	



Powerex, Inc., Hillis Street, Youngwood, Pennsylvania 15697 (412) 925-7272  
 Powerex Europe, S.A., 428 Ave. G. Durand, BP107, 72003 LeMans, France (43) 72.75.15

**C430**  
**Phase Control SCR**  
 680 Amperes Avg/500-1300 Volts

**Absolute Maximum Ratings**

	Symbol	C430	Units
RMS On-State Current	$I_{T(RMS)}$	1070	Amperes
Average On-State Current	$I_{T(av)}$	680	Amperes
Peak One-Cycle Surge (Non-Repetitive) On-State Current (60Hz)	$I_{TSM}$	8000	Amperes
Peak One-Cycle Surge (Non-Repetitive) On-State Current (50Hz)	$I_{TSM}$	7300	Amperes
Critical Rate-of-Rise of On-State Current (Non-Repetitive)	di/dt	400	Amperes/ $\mu$ s
Critical Rate-of-Rise of On-State Current (Repetitive)	di/dt	150	Amperes/ $\mu$ s
$I^2t$ (for Fusing), One Cycle at 60Hz	$I^2t$	265,000	A <sup>2</sup> sec
Peak Gate Power Dissipation	$P_{GM}$	20	Watts
Average Gate Power Dissipation	$P_{G(av)}$	5	Watts
Storage Temperature	$T_{STG}$	-40 to 150	°C
Operating Temperature	$T_J$	-40 to 125	°C
Mounting Force <sup>ⓐ</sup>		800 to 2500	lb.
Mounting Force <sup>ⓐ</sup>		3.6 to 11.1	kN

ⓐ Consult recommended mounting procedures.

Powerex, Inc., Hillis Street, Youngwood, Pennsylvania 15697 (412) 925-7272

Powerex Europe, S.A., 428 Ave. G. Durand, BP107, 72003 LeMans, France (43) 72.75.15

C430

Phase Control SCR

680 Amperes Avg/500-1300 Volts

## Electrical and Thermal Characteristics

Characteristics	Symbol	Test Conditions	C430	Units
<b>Voltage—Blocking State Maximums</b>				
Forward Leakage, Peak	$I_{DRM}$	$T_J = 125^\circ\text{C}, V = V_{DRM}$	20	mA
Reverse Leakage, Peak	$I_{RRM}$	$T_J = 125^\circ\text{C}, V = V_{RRM}$	20	mA
<b>Current—Conducting State Maximums</b>				
Peak On-State Voltage	$V_{TM}$	$T_C = 25^\circ\text{C}, I_L = 3000\text{A Peak},$ Duty Cycle $\leq 0.01\%$	2.4	Volts
<b>Switching</b>				
Typical Turn-Off Time	$t_q$	$T_J = 125^\circ\text{C}; I_{TM} = 500\text{A}, V_R = 50\text{V min};$ $V_{DRM}$ (Reapplied); Reapplied $dv/dt = 20\text{V}/\mu\text{sec}$ (linear); Commutation $di/dt = 25\text{A}/\mu\text{sec};$ Repetition Rate = 1 pps; Gate Bias during turn-off interval = 0V; $100\Omega$	125	$\mu\text{sec}$
Typical Delay Time	$t_d$	$T_C = 25^\circ\text{C}, I_T = 50\text{A},$ Gate Supply: 20 Volts, $20\Omega$ , $0.1\mu\text{sec}$ rise time	0.7	$\mu\text{sec}$
Min. Critical $dv/dt$ exponential to $V_{DRM}$	$dv/dt$	$T_J = 125^\circ\text{C}, V_{DRM} = \text{rated}, \text{Gate Open}$	200	$\text{V}/\mu\text{sec}$
<b>Thermal</b>				
Maximum Thermal Resistance, <sup>ⓐ</sup> double sided cooling				
Junction to Case (2000 lb. force)	$R_{\theta JC}$		.04	$^\circ\text{C}/\text{Watt}$
Case to Sink, Lubricated (2000 lb. force)	$R_{\theta CS}$		.02	$^\circ\text{C}/\text{Watt}$
<b>Gate—Maximum Parameters</b>				
Gate Current to Trigger	$I_{GT}$	$V_D = 6\text{Vdc}, T_J = 25^\circ\text{C}, R_L = 3\Omega$	125	mA
Gate Voltage to Trigger	$V_{GT}$	$T_J = -40^\circ\text{C to } 125^\circ\text{C}, V_D = 6\text{Vdc}, R_L = 3\Omega$	5	Volts
Non-Triggering Gate Voltage	$V_{GDM}$	$T_J = 125^\circ\text{C}, \text{rated } V_{DRM}, R_L = 1000\Omega$	.15	Volts
Peak Forward Gate Current	$I_{GTM}$		10	Amperes
Peak Reverse Gate Voltage	$V_{GRM}$		5	Volts

<sup>ⓐ</sup> Consult recommended mounting procedures.

Powerex, Inc., Hillis Street, Youngwood, Pennsylvania 15697 (412) 925-7272  
 Powerex Europe, S.A., 428 Ave. G. Durand, BP107, 72003 LeMans, France (43) 72.75.15

**C430**  
**Phase Control SCR**  
 680 Amperes Avg/500-1300 Volts

**MAXIMUM ON-STATE CHARACTERISTICS**

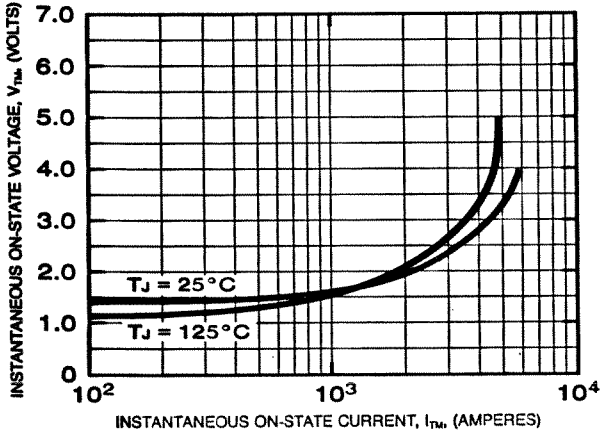

**TRANSIENT THERMAL IMPEDANCE CHARACTERISTICS (JUNCTION TO CASE)**

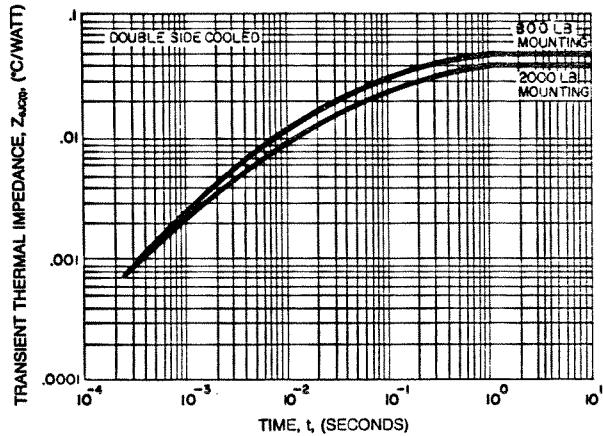

**MAXIMUM ALLOWABLE CASE TEMPERATURE (SINUSOIDAL WAVEFORM)**

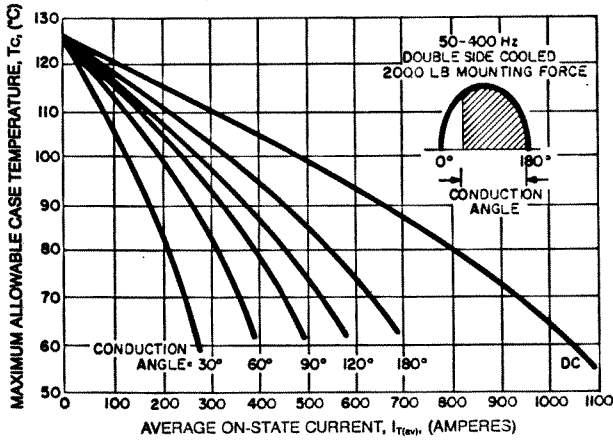

**MAXIMUM ON-STATE POWER DISSIPATION (SINUSOIDAL WAVEFORM)**

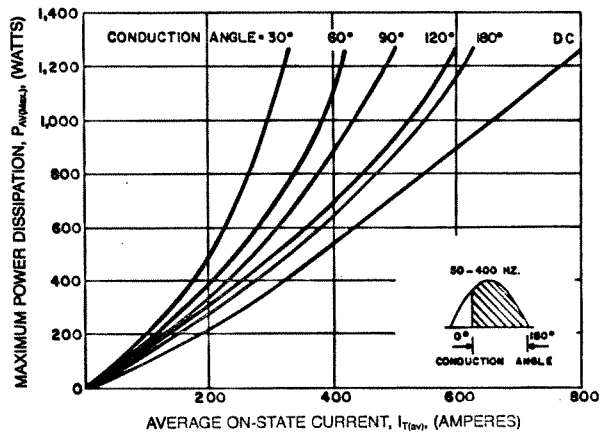

**MAXIMUM ALLOWABLE CASE TEMPERATURE (RECTANGULAR WAVEFORM)**

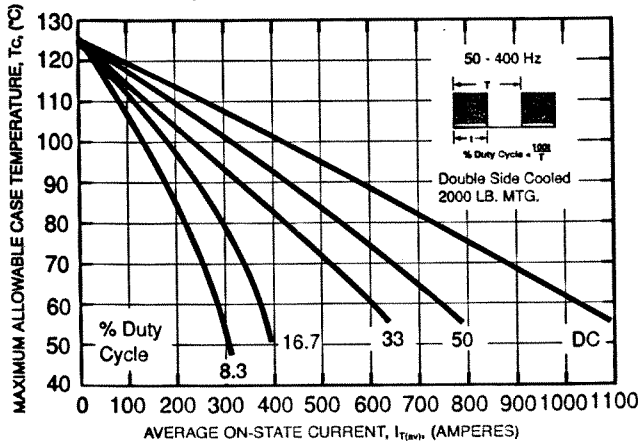

**MAXIMUM ON-STATE POWER DISSIPATION (RECTANGULAR WAVEFORM)**

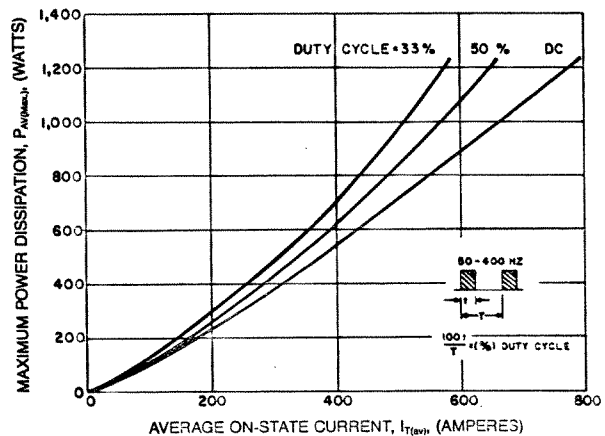

Powerex, Inc., Hillis Street, Youngwood, Pennsylvania 15697 (412) 925-7272  
 Powerex Europe, S.A., 428 Ave. G. Durand, BP107, 72003 LeMans, France (43) 72.75.15

**C430**  
**Phase Control SCR**  
 680 Amperes Avg/500-1300 Volts

**MAXIMUM ALLOWABLE CASE TEMPERATURE (SINUSOIDAL WAVEFORM)**

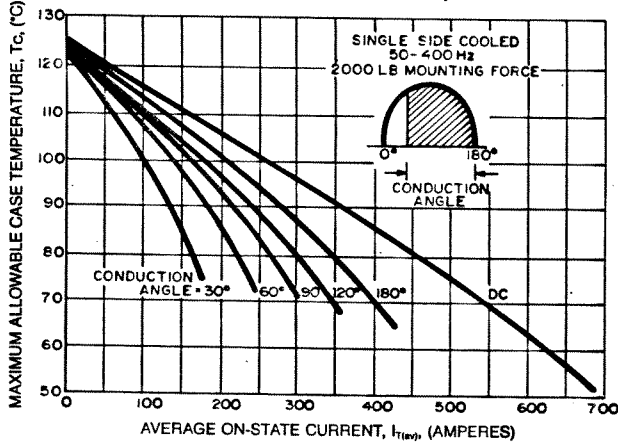

**MAXIMUM ALLOWABLE CASE TEMPERATURE (RECTANGULAR WAVEFORM)**

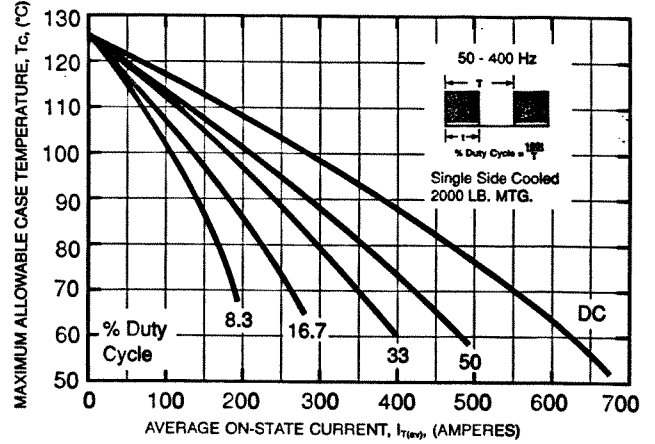

**MAXIMUM ALLOWABLE CASE TEMPERATURE (SINUSOIDAL WAVEFORM)**

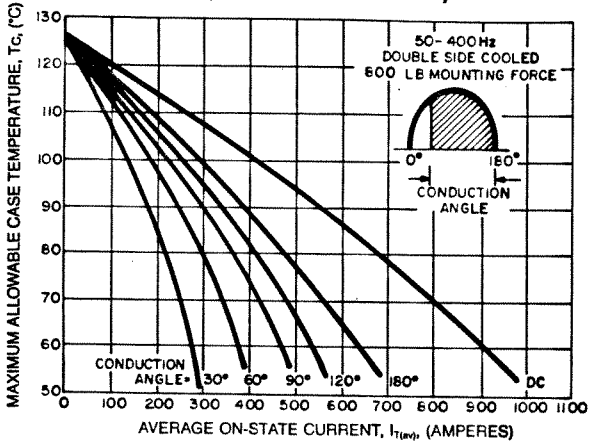

**MAXIMUM ALLOWABLE CASE TEMPERATURE (RECTANGULAR WAVEFORM)**

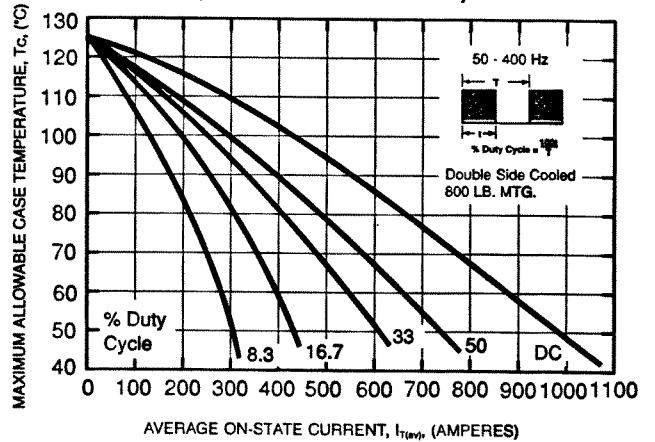

**MAXIMUM ALLOWABLE CASE TEMPERATURE (SINUSOIDAL WAVEFORM)**

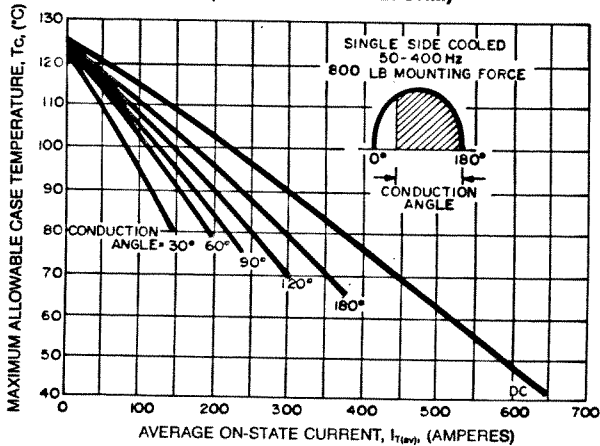

**MAXIMUM ALLOWABLE CASE TEMPERATURE (RECTANGULAR WAVEFORM)**

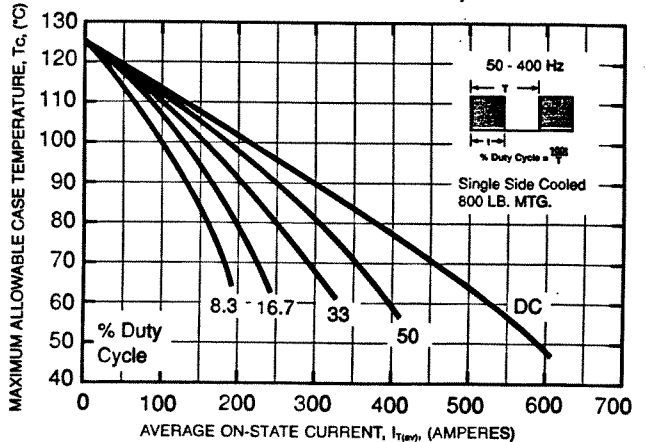



Powerex, Inc., Hillis Street, Youngwood, Pennsylvania 15697 (412) 925-7272  
 Powerex Europe, S.A., 428 Ave. G. Durand, BP107, 72003 LeMans, France (43) 72.75.15

**C430**  
**Phase Control SCR**  
 680 Amperes Avg/500-1300 Volts

**SUB-CYCLE SURGE AND  $I^2t$  RATINGS**  
 (RATED LOAD CONDITIONS)

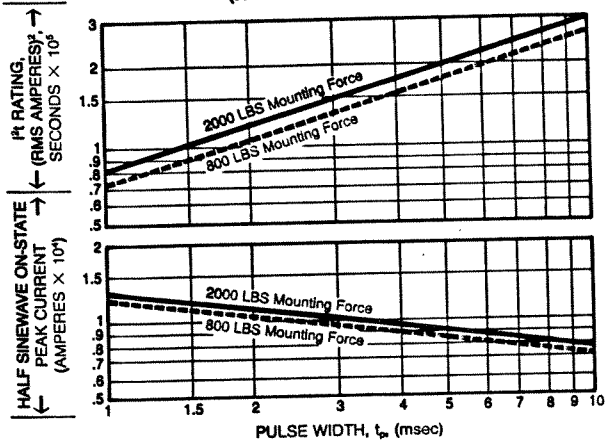

**MAXIMUM ALLOWABLE SURGE ON-STATE CURRENT (NON-REPETITIVE)**

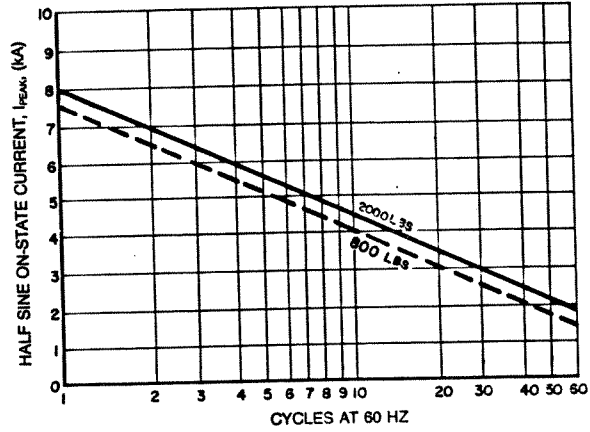

**GATE CHARACTERISTICS**

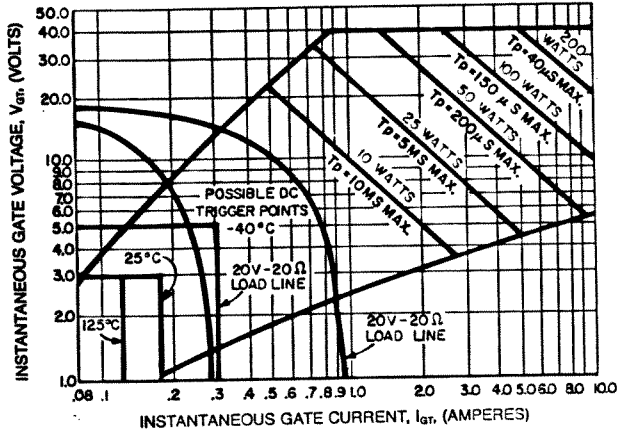

**NOTES:**

1. Maximum allowable average gate dissipation = 5 watts.
2. The locus of possible dc trigger points lie outside the boundaries shown at various case temperatures.
3.  $T_p$  = Rectangular gate current pulse width (5μs min. duration; 1.0μs max. rise time for 20V, 65Ω source).
4. 20V - 20Ω is the minimum gate source load line when rate of circuit current rise > 100 Amp/μs or anode rate of current rise > 200 Amps/μs ( $T_p = 5μs$  min., 0.5μs max. rise time).

Maximum long-term repetitive anode  $di/dt = 500$  Amps/μs with 20V - 20Ω gate source.