

REVISIONS			
REV	ECN, ERN NO.	DATE	APPRD.
C	PRODUCT DRAWING (EAR 12900)	JAN26/06	K.L.

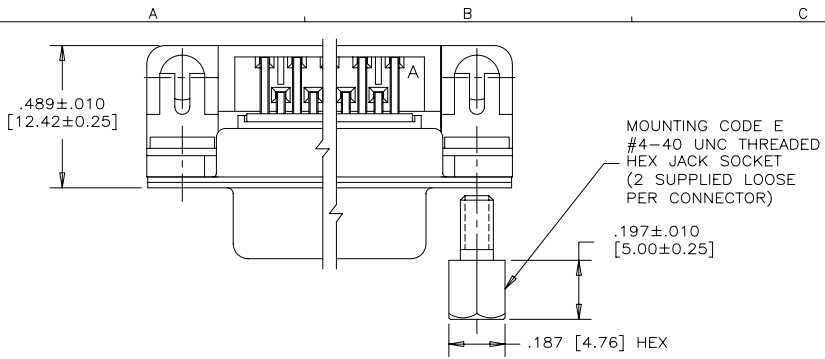

ORDERING CODE: F C E 1 7 - E 0 9 P A - 4 4 0 G

SERIES
FCE17=FILTERED D-SUB, RoHS

SIZE/NUMBER OF CONTACTS
E09, A15, B25, OR C37

CONNECTOR STYLE
P=PIN
S=SOCKET

TERMINATION TYPE
A=.318" [8.08] FOOTPRINT

CONTACT FINISH/GOLD THICKNESS
NO DIGIT=STANDARD 15 MICRONS
[0.38 MICRONS] GOLD ON MATING AREA
G=50 MICRONS [1.27 MICRONS] GOLD ON MATING AREA

MODIFIER
0=STANDARD

FILTER CAPACITANCE
D=50 pF 7=1200 pF
B=100 pF 6=1300 pF (PROPOSED)
O=180 pF J=1500 pF
F=330 pF E=2200 pF
1=470 pF 9=5600 pF
4=820 pF 8=47000 pF
5=1000 pF N=NO FILTERS

REFER TO AMPHENOL CATALOGUE FOR FILTER PERFORMANCE CHARACTERISTICS

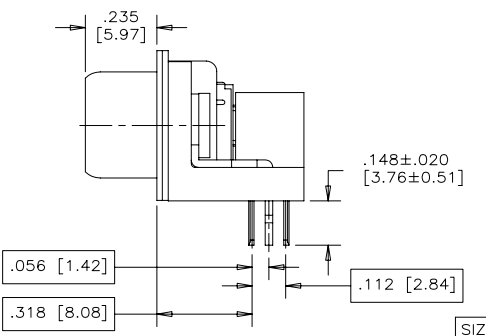
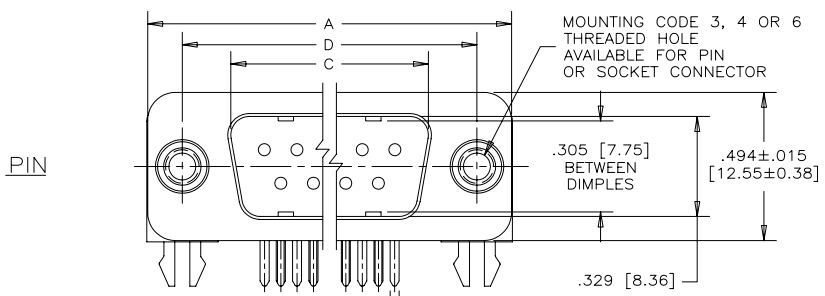
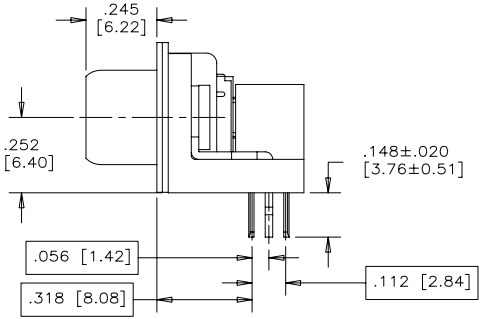
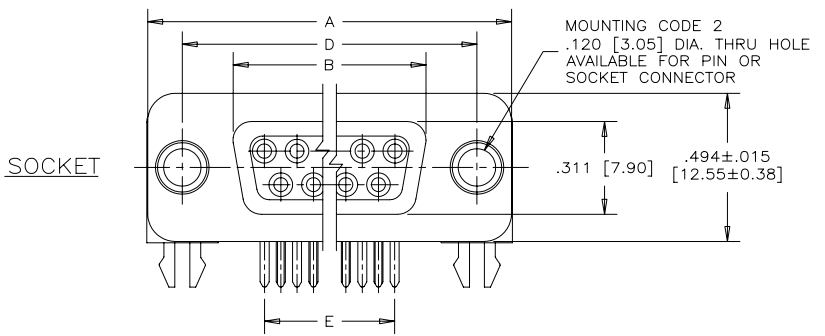

NOTES:

- MATERIALS: ALL MATERIALS ARE RoHS COMPLIANT.
 - SHELL: STEEL, TIN PLATED
 - CONTACTS: PHOSPHOR BRONZE, PLATED WITH GOLD OVER 50µ" [1.27 MICRONS] MINIMUM NICKEL IN THE MATING AREA AND 100µ" [2.54 MICRONS] MINIMUM MATTE TIN ON THE TAILS.
 - INSULATOR: ENGINEERING THERMOPLASTIC, GLASS REINFORCED, UL FLAMMABILITY RATING 94V-0, COLOUR: BLACK
 - BOARDLOCK: COPPER ALLOY, TIN PLATED
 - MOUNTING HARDWARE, STEEL OR COPPER ALLOY, TIN OR NICKEL PLATED.
- CONTACT RESISTANCE: 15 MILLIOHMS MAXIMUM
- INSULATION RESISTANCE: 3000 MEGOHMS MINIMUM
- CURRENT RATING: 5 AMPS MAXIMUM
- OPERATING TEMPERATURE: -40°C TO 85°C
- TOLERANCE UNLESS INDICATED OTHERWISE: ±.005 [0.13]

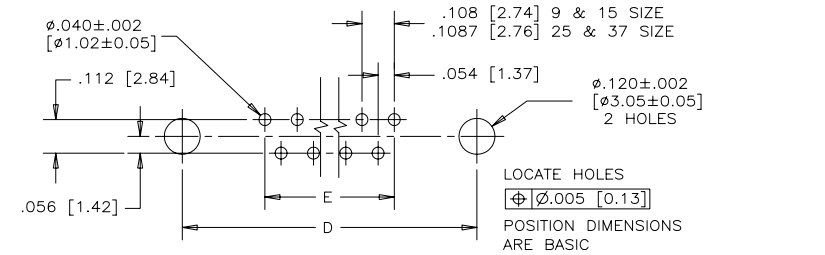
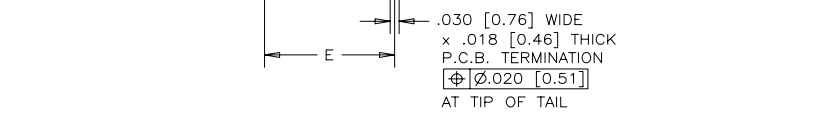

CAPACITANCE SCHEMATIC FOR EACH POSITION

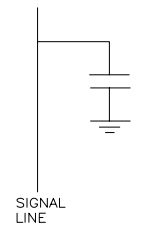

SIZE	STYLE	A±.015 [0.38]	B±.005 [0.13]	C±.005 [0.13]	D±.005 [0.13]	E BSC.
E09	PIN	1.213 [30.81]	-----	.666 [16.92]	.984 [24.99]	.432 [10.97]
	SOCKET		.643 [16.33]	-----		
A15	PIN	1.541 [39.14]	-----	.994 [25.25]	1.312 [33.32]	.756 [19.20]
	SOCKET		.971 [24.66]	-----		
B25	PIN	2.088 [53.04]	-----	1.534 [38.96]	1.852 [47.04]	1.304 [33.12]
	SOCKET		1.511 [38.38]	-----		
C37	PIN	2.729 [69.32]	-----	2.182 [55.42]	2.500 [63.50]	1.956 [49.68]
	SOCKET		2.159 [54.84]	-----		

DRAWN K. LAMBIE	DATE APR08/05
DESIGNED	
CHECKED	
I. E. APPRD.	
Q. A. APPRD.	
DWG. APPRD.	
ENG. REL. NO.	
REF. EAR #12701	
DIMENSIONS ARE IN INCHES [mm]	CODE ID. NO. 03554

Amphenol Canada Corp.

FCE17 SERIES FILTERED D-SUB CONNECTOR, PIN & SOCKET, RIGHT ANGLE .318 [8.08] F/P, PLASTIC MOUNTING BRACKET & BOARDLOCK, RoHS COMPLIANT

DWG	DRAWING NO.	REV.
C	P-FCE17-XXXXA-XX0X	C
SCALE	3/1	WT. -----
SURF.	-----	SHEET 1 of 1

THIS DOCUMENT CONTAINS PROPRIETARY INFORMATION AND SUCH INFORMATION MAY NOT BE DISCLOSED TO OTHERS FOR ANY PURPOSE OR USED FOR MANUFACTURING PURPOSES WITHOUT WRITTEN PERMISSION FROM AMPHENOL CANADA CORP.