

MCR12DSM, MCR12DSN

Preferred Device

Sensitive Gate Silicon Controlled Rectifiers

Reverse Blocking Thyristors

Designed for high volume, low cost, industrial and consumer applications such as motor control; process control; temperature, light and speed control.

Features

- Small Size
- Passivated Die for Reliability and Uniformity
- Low Level Triggering and Holding Characteristics
- Epoxy Meets UL 94 V-0 @ 0.125 in
- ESD Ratings: Human Body Model, 3B > 8000 V
Machine Model, C > 400 V
- Pb-Free Packages are Available

MAXIMUM RATINGS (T_J = 25°C unless otherwise noted)

Rating	Symbol	Value	Unit
Peak Repetitive Off-State Voltage (Note 1) (T _J = -40 to 110°C, Sine Wave, 50 Hz to 60 Hz) MCR12DSM MCR12DSN	V _{DRM} , V _{RRM}	600 800	V
On-State RMS Current (180° Conduction Angles; T _C = 75°C)	I _{T(RMS)}	12	A
Average On-State Current (180° Conduction Angles; T _C = 75°C)	I _{T(AV)}	7.6	A
Peak Non-Repetitive Surge Current (1/2 Cycle, Sine Wave 60 Hz, T _J = 110°C)	I _{TSM}	100	A
Circuit Fusing Consideration (t = 8.3 msec)	I ² t	41	A ² sec
Forward Peak Gate Power (Pulse Width ≤ 10 μsec, T _C = 75°C)	P _{GM}	5.0	W
Forward Average Gate Power (t = 8.3 msec, T _C = 75°C)	P _{G(AV)}	0.5	W
Forward Peak Gate Current (Pulse Width ≤ 10 μsec, T _C = 75°C)	I _{GM}	2.0	A
Operating Junction Temperature Range	T _J	-40 to 110	°C
Storage Temperature Range	T _{stg}	-40 to 150	°C

Stresses exceeding Maximum Ratings may damage the device. Maximum Ratings are stress ratings only. Functional operation above the Recommended Operating Conditions is not implied. Extended exposure to stresses above the Recommended Operating Conditions may affect device reliability.

1. V_{DRM} and V_{RRM} for all types can be applied on a continuous basis. Ratings apply for zero or negative gate voltage; however, positive gate voltage shall not be applied concurrent with negative potential on the anode. Blocking voltages shall not be tested with a constant current source such that the voltage ratings of the device are exceeded.



ON Semiconductor®

<http://onsemi.com>

SCRs
12 AMPERES RMS
600 – 800 VOLTS



MARKING DIAGRAMS

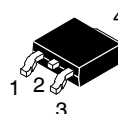

DPAK
CASE 369C
STYLE 4

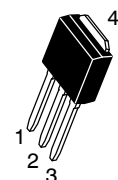
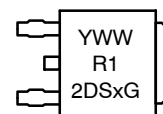

DPAK-3
CASE 369D
STYLE 4

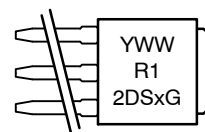

Y = Year
WW = Work Week
R12DSx = Device Code
x = M or N
G = Pb-Free Package

PIN ASSIGNMENT

Pin	Assignment
1	Cathode
2	Anode
3	Gate
4	Anode

ORDERING INFORMATION

See detailed ordering and shipping information in the package dimensions section on page 5 of this data sheet.

Preferred devices are recommended choices for future use and best overall value.

MCR12DSM, MCR12DSN

THERMAL CHARACTERISTICS

Characteristic	Symbol	Max	Unit
Thermal Resistance, – Junction-to-Case	$R_{\theta JC}$	2.2	$^{\circ}C/W$
– Junction-to-Ambient	$R_{\theta JA}$	88	
– Junction-to-Ambient (Note 2)	$R_{\theta JA}$	80	
Maximum Lead Temperature for Soldering Purposes (Note 3)	T_L	260	$^{\circ}C$

ELECTRICAL CHARACTERISTICS ($T_J = 25^{\circ}C$ unless otherwise noted)

Characteristics	Symbol	Min	Typ	Max	Unit
-----------------	--------	-----	-----	-----	------

OFF CHARACTERISTICS

Peak Repetitive Forward or Reverse Blocking Current (Note 4) ($V_{AK} = \text{Rated } V_{DRM} \text{ or } V_{RRM}; R_{GK} = 1.0 \text{ K}\Omega$)	$I_{DRM},$ I_{RRM}	–	–	10	μA
$T_J = 25^{\circ}C$		–	–	500	
$T_J = 110^{\circ}C$		–	–		

ON CHARACTERISTICS

Peak Reverse Gate Blocking Voltage, ($I_{GR} = 10 \mu A$)	V_{GRM}	10	12.5	18	V
Peak Reverse Gate Blocking Current, ($V_{GR} = 10 \text{ V}$)	I_{GRM}	–	–	1.2	μA
Peak Forward On-State Voltage (Note 5), ($I_{TM} = 20 \text{ A}$)	V_{TM}	–	1.3	1.9	V
Gate Trigger Current (Continuous dc) (Note 6) ($V_D = 12 \text{ V}, R_L = 100 \Omega$)	I_{GT}	5.0	12	200	μA
$T_J = 25^{\circ}C$		–	–	300	
$T_J = -40^{\circ}C$					
Gate Trigger Voltage (Continuous dc) (Note 6) ($V_D = 12 \text{ V}, R_L = 100 \Omega$)	V_{GT}	0.45	0.65	1.0	V
$T_J = 25^{\circ}C$		–	–	1.5	
$T_J = -40^{\circ}C$		0.2	–	–	
$T_J = 110^{\circ}C$					
Holding Current ($V_D = 12 \text{ V}, \text{Initiating Current} = 200 \text{ mA}, R_{GK} = 1 \text{ k}\Omega$)	I_H	0.5	1.0	6.0	mA
$T_J = 25^{\circ}C$		–	–	10	
$T_J = -40^{\circ}C$					
Latching Current ($V_D = 12 \text{ V}, I_G = 2.0 \text{ mA}, R_{GK} = 1 \text{ k}\Omega$)	I_L	0.5	1.0	6.0	mA
$T_J = 25^{\circ}C$		–	–	10	
$T_J = -40^{\circ}C$					
Turn-On Time (Source Voltage = 12 V, $R_S = 6.0 \text{ K}\Omega$, $I_T = 16 \text{ A(pk)}, R_{GK} = 1.0 \text{ K}\Omega$) ($V_D = \text{Rated } V_{DRM}$, Rise Time = 20 ns, Pulse Width = 10 μs)	tgt	–	2.0	5.0	μs

DYNAMIC CHARACTERISTICS

Critical Rate of Rise of Off-State Voltage ($V_D = 0.67 \times \text{Rated } V_{DRM}$, Exponential Waveform, $R_{GK} = 1.0 \text{ K}\Omega$, $T_J = 110^{\circ}C$)	dv/dt	2.0	10	–	V/ μs
---	-------	-----	----	---	------------

- These ratings are applicable when surface mounted on the minimum pad sizes recommended.
- 1/8" from case for 10 seconds.
- Ratings apply for negative gate voltage or $R_{GK} = 1.0 \text{ k}\Omega$. Devices shall not have a positive gate voltage concurrently with a negative voltage on the anode. Devices should not be tested with a constant current source for forward and reverse blocking capability such that the voltage applied exceeds the rated blocking voltage.
- Pulse Test: Pulse Width $\leq 2.0 \text{ msec}$, Duty Cycle $\leq 2\%$.
- R_{GK} current not included in measurement.

MCR12DSM, MCR12DSN

Voltage Current Characteristic of SCR

Symbol	Parameter
V_{DRM}	Peak Repetitive Off State Forward Voltage
I_{DRM}	Peak Forward Blocking Current
V_{RRM}	Peak Repetitive Off State Reverse Voltage
I_{RRM}	Peak Reverse Blocking Current
V_{TM}	Peak On State Voltage
I_H	Holding Current

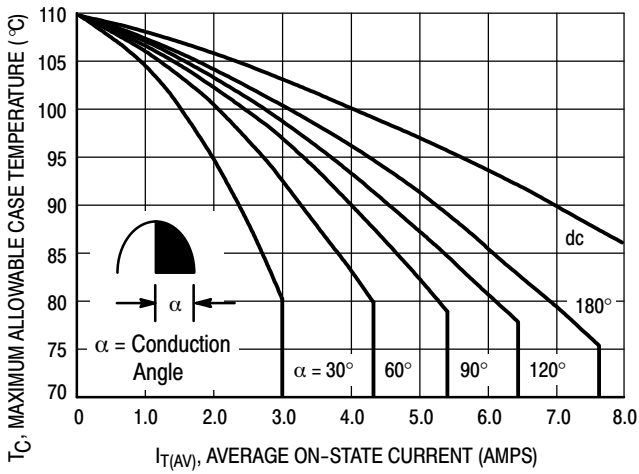
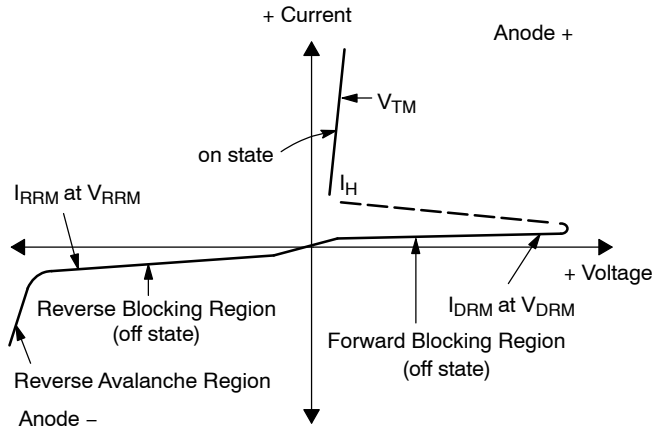

Figure 1. Average Current Derating

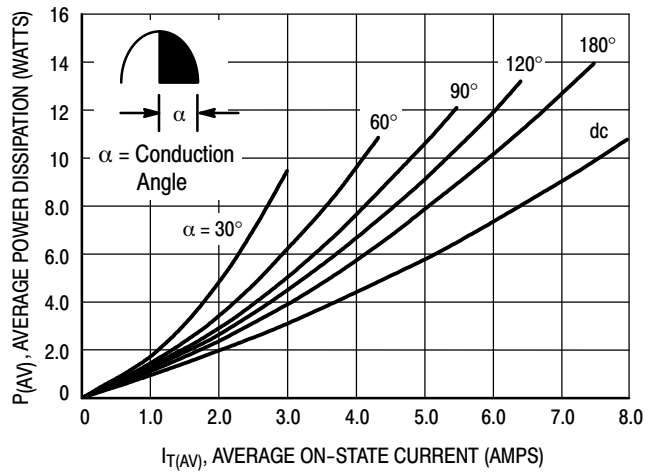

Figure 2. On-State Power Dissipation

MCR12DSM, MCR12DSN

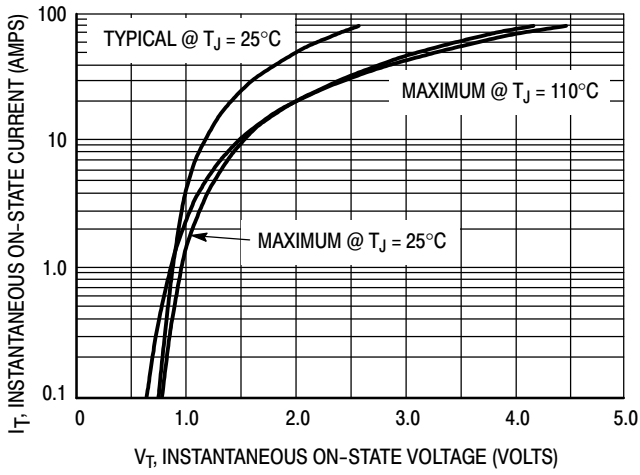

Figure 3. On-State Characteristics

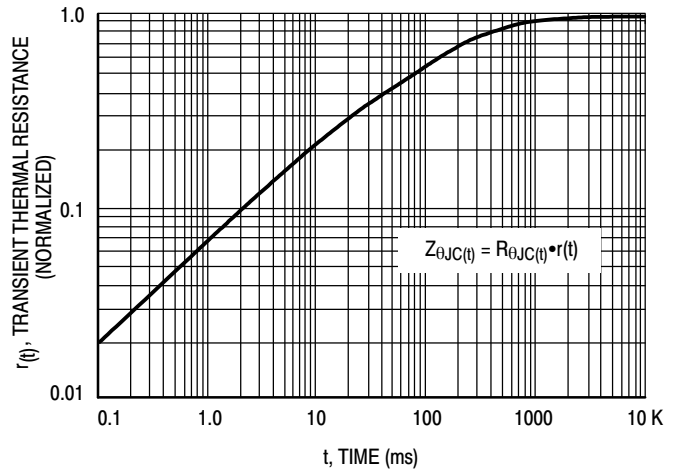

Figure 4. Transient Thermal Response

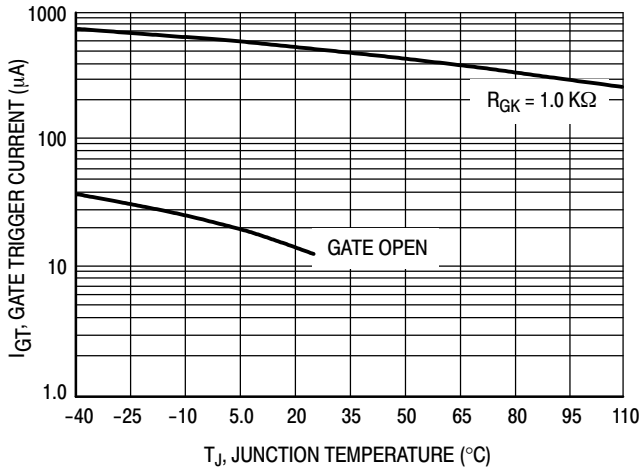

Figure 5. Typical Gate Trigger Current versus Junction Temperature

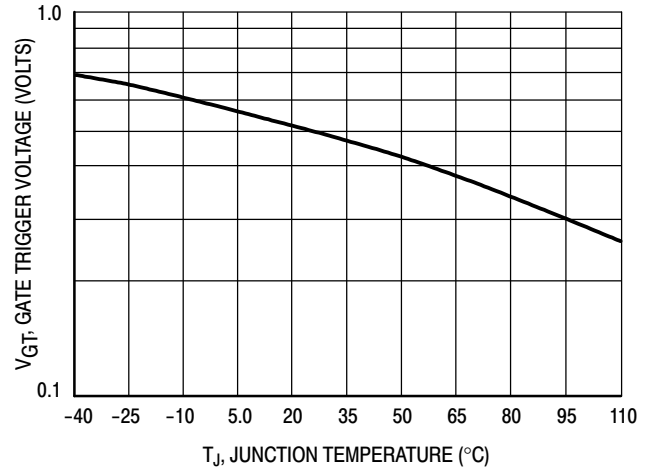

Figure 6. Typical Gate Trigger Voltage versus Junction Temperature

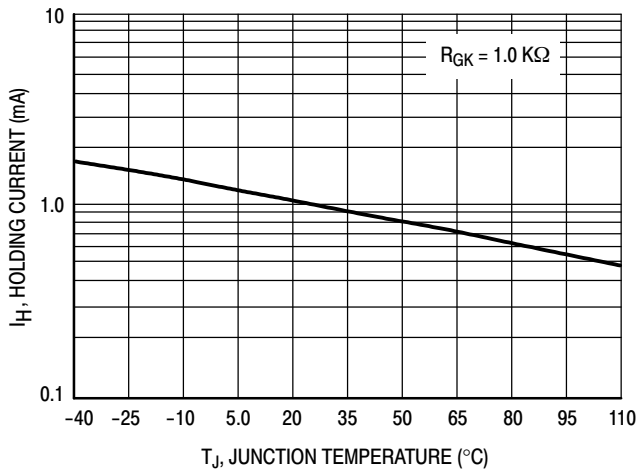

Figure 7. Typical Holding Current versus Junction Temperature

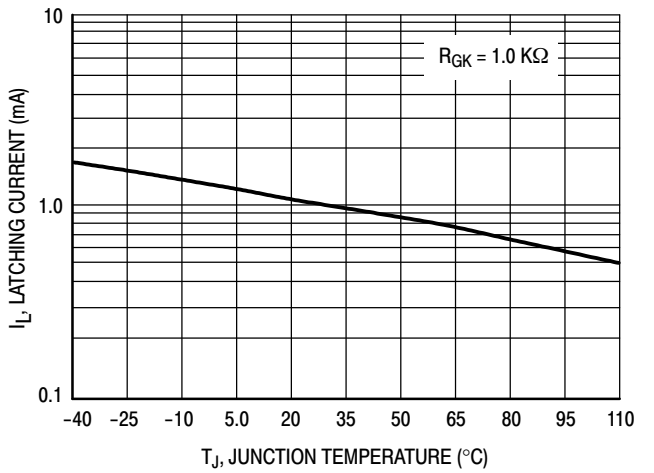

Figure 8. Typical Latching Current versus Junction Temperature

MCR12DSM, MCR12DSN

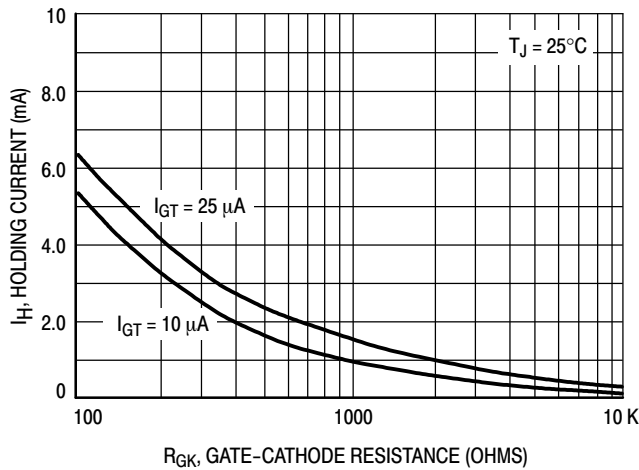

Figure 9. Holding Current versus Gate-Cathode Resistance

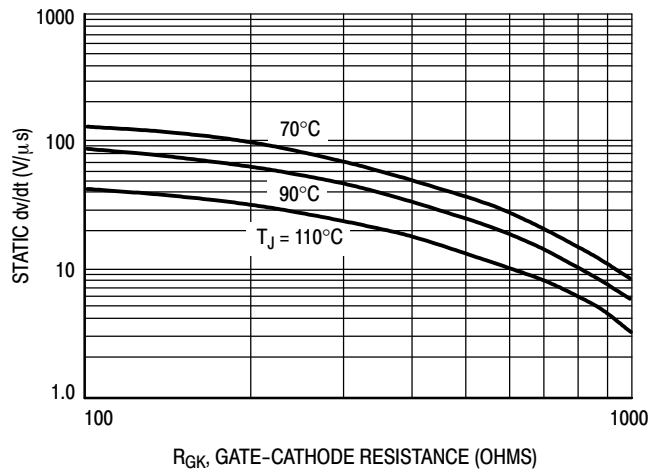

Figure 10. Exponential Static dv/dt versus Gate-Cathode Resistance and Junction Temperature

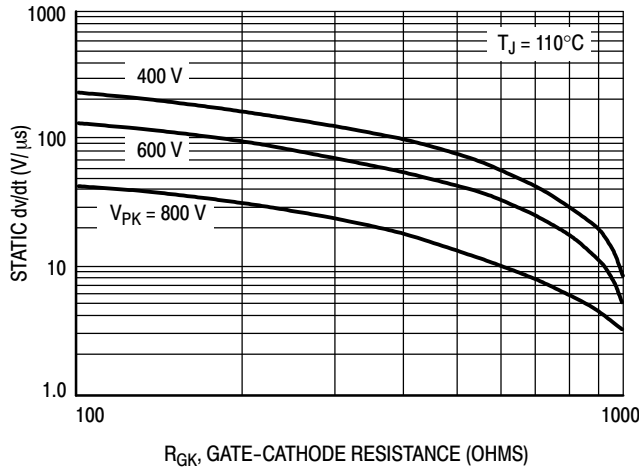

Figure 11. Exponential Static dv/dt versus Gate-Cathode Resistance and Peak Voltage

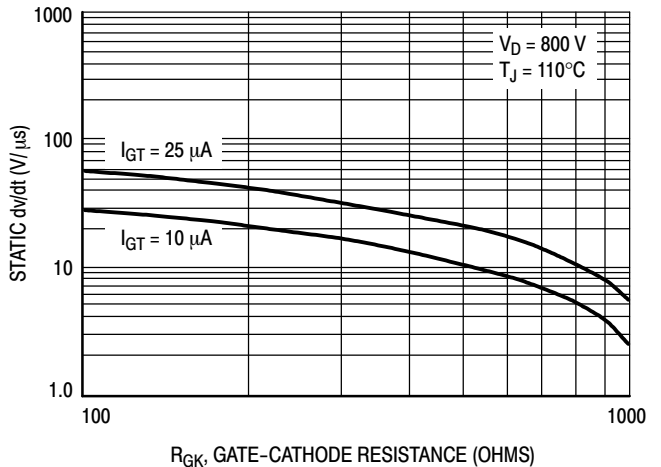

Figure 12. Exponential Static dv/dt versus Gate-Cathode Resistance and Gate Trigger Current Sensitivity

ORDERING INFORMATION

Device	Package Type	Package	Shipping†
MCR12DSMT4	DPAK	369C	2500 / Tape & Reel
MCR12DSMT4G	DPAK (Pb-Free)	369C	2500 / Tape & Reel
MCR12DSN-001	DPAK-3	369D	75 Units / Rail
MCR12DSN-001G	DPAK-3 (Pb-Free)	369D	75 Units / Rail
MCR12DSNT4	DPAK	369C	2500 / Tape & Reel
MCR12DSNT4G	DPAK (Pb-Free)	369C	2500 / Tape & Reel

†For information on tape and reel specifications, including part orientation and tape sizes, please refer to our Tape and Reel Packaging Specifications Brochure, BRD8011/D.

MCR12DSM, MCR12DSN

PACKAGE DIMENSIONS

DPAK (SINGLE GAUGE)
CASE 369C-01
ISSUE A

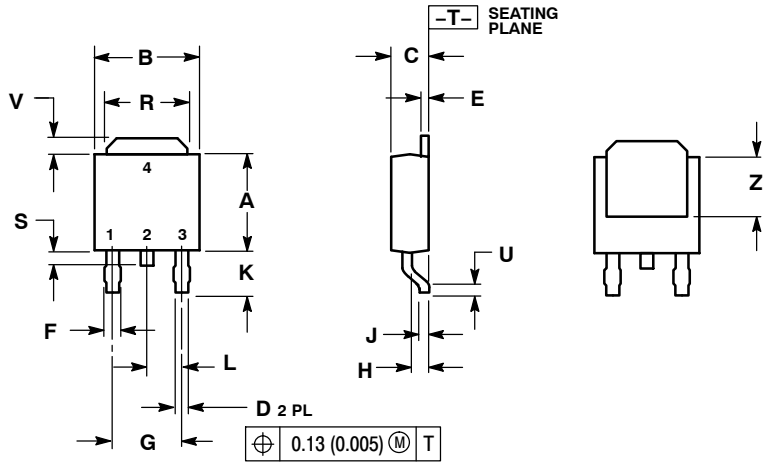

NOTES:

1. DIMENSIONING AND TOLERANCING PER ANSI Y14.5M, 1982.
2. CONTROLLING DIMENSION: INCH.

DIM	INCHES		MILLIMETERS	
	MIN	MAX	MIN	MAX
A	0.235	0.245	5.97	6.22
B	0.250	0.265	6.35	6.73
C	0.086	0.094	2.19	2.38
D	0.027	0.035	0.69	0.88
E	0.018	0.023	0.46	0.58
F	0.037	0.045	0.94	1.14
G	0.180 BSC		4.58 BSC	
H	0.034	0.040	0.87	1.01
J	0.018	0.023	0.46	0.58
K	0.102	0.114	2.60	2.89
L	0.090 BSC		2.29 BSC	
R	0.180	0.215	4.57	5.45
S	0.025	0.040	0.63	1.01
U	0.020	---	0.51	---
V	0.035	0.050	0.89	1.27
Z	0.155	---	3.93	---

STYLE 4:

- PIN 1. CATHODE
2. ANODE
3. GATE
4. ANODE

SOLDERING FOOTPRINT*

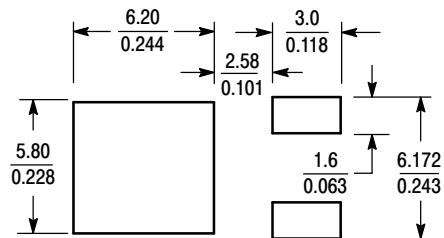

SCALE 3:1 $\left(\frac{\text{mm}}{\text{inches}} \right)$

*For additional information on our Pb-Free strategy and soldering details, please download the ON Semiconductor Soldering and Mounting Techniques Reference Manual, SOLDERRM/D.

MCR12DSM, MCR12DSN

PACKAGE DIMENSIONS

DK-3
 CASE 369D-01
 ISSUE B

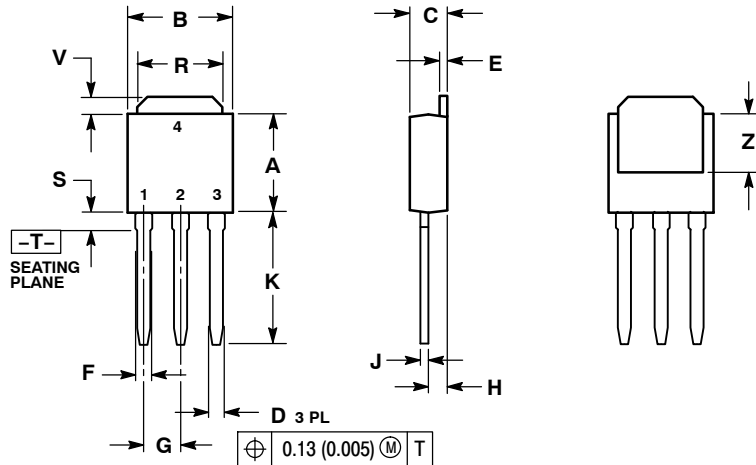

NOTES:

1. DIMENSIONING AND TOLERANCING PER ANSI Y14.5M, 1982.
2. CONTROLLING DIMENSION: INCH.

DIM	INCHES		MILLIMETERS	
	MIN	MAX	MIN	MAX
A	0.235	0.245	5.97	6.35
B	0.250	0.265	6.35	6.73
C	0.086	0.094	2.19	2.38
D	0.027	0.035	0.69	0.88
E	0.018	0.023	0.46	0.58
F	0.037	0.045	0.94	1.14
G	0.090	BSC	2.29	BSC
H	0.034	0.040	0.87	1.01
J	0.018	0.023	0.46	0.58
K	0.350	0.380	8.89	9.65
R	0.180	0.215	4.45	5.45
S	0.025	0.040	0.63	1.01
V	0.035	0.050	0.89	1.27
Z	0.155	---	3.93	---

STYLE 4:

- PIN 1. CATHODE
 2. ANODE
 3. GATE
 4. ANODE

ON Semiconductor and are registered trademarks of Semiconductor Components Industries, LLC (SCILLC). SCILLC reserves the right to make changes without further notice to any products herein. SCILLC makes no warranty, representation or guarantee regarding the suitability of its products for any particular purpose, nor does SCILLC assume any liability arising out of the application or use of any product or circuit, and specifically disclaims any and all liability, including without limitation special, consequential or incidental damages. "Typical" parameters which may be provided in SCILLC data sheets and/or specifications can and do vary in different applications and actual performance may vary over time. All operating parameters, including "Typicals" must be validated for each customer application by customer's technical experts. SCILLC does not convey any license under its patent rights nor the rights of others. SCILLC products are not designed, intended, or authorized for use as components in systems intended for surgical implant into the body, or other applications intended to support or sustain life, or for any other application in which the failure of the SCILLC product could create a situation where personal injury or death may occur. Should Buyer purchase or use SCILLC products for any such unintended or unauthorized application, Buyer shall indemnify and hold SCILLC and its officers, employees, subsidiaries, affiliates, and distributors harmless against all claims, costs, damages, and expenses, and reasonable attorney fees arising out of, directly or indirectly, any claim of personal injury or death associated with such unintended or unauthorized use, even if such claim alleges that SCILLC was negligent regarding the design or manufacture of the part. SCILLC is an Equal Opportunity/Affirmative Action Employer. This literature is subject to all applicable copyright laws and is not for resale in any manner.

PUBLICATION ORDERING INFORMATION

LITERATURE FULFILLMENT:
 Literature Distribution Center for ON Semiconductor
 P.O. Box 5163, Denver, Colorado 80217 USA
Phone: 303-675-2175 or 800-344-3860 Toll Free USA/Canada
Fax: 303-675-2176 or 800-344-3867 Toll Free USA/Canada
Email: orderlit@onsemi.com

N. American Technical Support: 800-282-9855 Toll Free USA/Canada
Europe, Middle East and Africa Technical Support:
 Phone: 421 33 790 2910
Japan Customer Focus Center
 Phone: 81-3-5773-3850

ON Semiconductor Website: www.onsemi.com
Order Literature: <http://www.onsemi.com/orderlit>

For additional information, please contact your local Sales Representative