

# RSEL SERIES

## Compact Multipurpose Type



### FEATURES

- Wire type and faston terminal type are available with the same shape.
- Optional low-leakage current characteristic type is also available.
- Compliant with RoHS directives.

### SAFETY STANDARDS

UL1283	File No. E62388
CSA C22.2 No.8	File No. 208777
EN60939	Licence Ref. No. SE/07115-1

### PRODUCT IDENTIFICATION

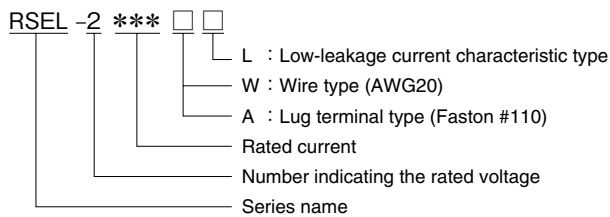

### CIRCUIT DIAGRAMS

RSEL-2 \*\*\* W  
RSEL-2 \*\*\* A

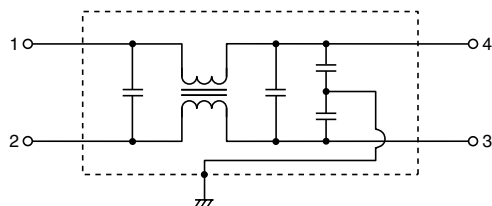

RSEL-2 \*\*\* WL  
RSEL-2 \*\*\* AL

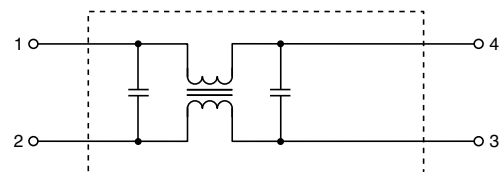

• Faston® is a registered trademark of Tyco Electronics AMP Corp. Incorporated.

• Conformity to RoHS Directive: This means that, in conformity with EU Directive 2002/95/EC, lead, cadmium, mercury, hexavalent chromium, and specific bromine-based flame retardants, PBB and PBDE, have not been used, except for exempted applications.

• All specifications are subject to change without notice.

## ELECTRICAL CHARACTERISTICS

Part No.	Rated voltage (AC/DC)	Rated current (AC/DC)	Withstand voltage	Insulation resistance	Leakage current	Operating temperature range	With derating over	DC resistance (mΩ)	Attenuation frequency range (MHz)	
									Common mode	Differential mode
									at 25dB	at 25dB
RSEL-20R5W/A	250V	0.5A	AC.2500V 60s [Between line to ground]	100MΩ min. [DC.500V/ 1min.]	1.0mA max. [250V/60Hz]	-25 to +85°C	55°C	700 max.	0.2 to 10	0.3 to 30
RSEL-2001W/A		1A						600 max.	0.3 to 10	0.5 to 30
RSEL-2002W/A		2A						250 max.	0.5 to 10	0.5 to 30
RSEL-2003W/A		3A						150 max.	0.5 to 10	0.5 to 30
RSEL-2006W/A		6A						80 max.	1 to 10	1 to 30

Part No.	Rated voltage (AC/DC)	Rated current (AC/DC)	Withstand voltage	Insulation resistance	Leakage current	Operating temperature range	With derating over	DC resistance (mΩ)	Attenuation frequency range (MHz)	
									Common mode	Differential mode
									at 15dB	at 25dB
RSEL-20R5WL/AL	250V	0.5A	AC.2500V 60s [Between line to ground]	100MΩ min. [DC.500V/ 1min.]	10 μ A max. [250V/60Hz]	-25 to +85°C	55°C	700 max.	0.1 to 5	0.3 to 30
RSEL-2001WL/AL		1A						600 max.	0.1 to 5	0.5 to 30
RSEL-2002WL/AL		2A						250 max.	0.1 to 5	0.5 to 30
RSEL-2003WL/AL		3A						150 max.	0.1 to 5	0.5 to 30
RSEL-2006WL/AL		6A						80 max.	1 to 30	1 to 30

## DERATINGS

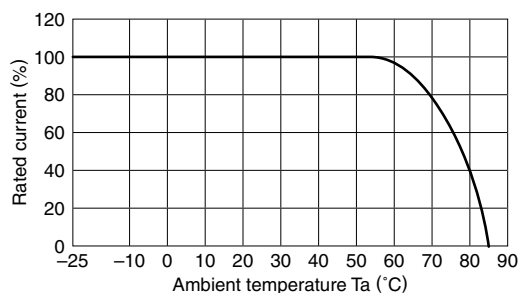

■ SHAPES AND DIMENSIONS

RSEL-20R5/2001/2002/2003/2006W(L)

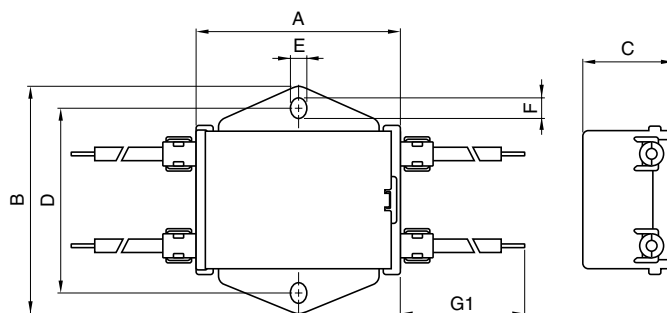

RSEL-20R5/2001/2002/2003/2006A(L)

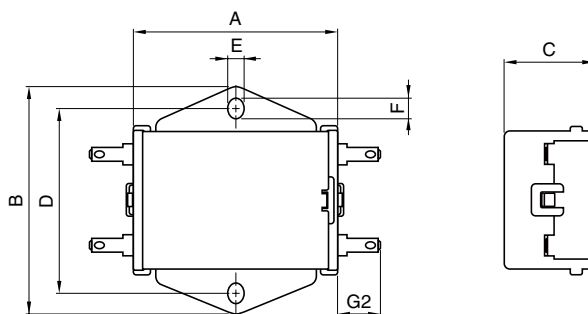

Dimensions in mm

Part No.	A	B	C	D	E	F	G1	G2
RSEL-20R5W(L)	45	50	20	40	3.5	4.5	300	-
RSEL-2001W(L)								
RSEL-2002W(L)								
RSEL-2003W(L)								
RSEL-2006W(L)								
RSEL-20R5A(L)	45	50	20	40	3.5	4.5	-	9
RSEL-2001A(L)								
RSEL-2002A(L)								
RSEL-2003A(L)								
RSEL-2006A(L)								

**ATTENUATION vs. FREQUENCY CHARACTERISTICS**

RSEL-20R5W/A

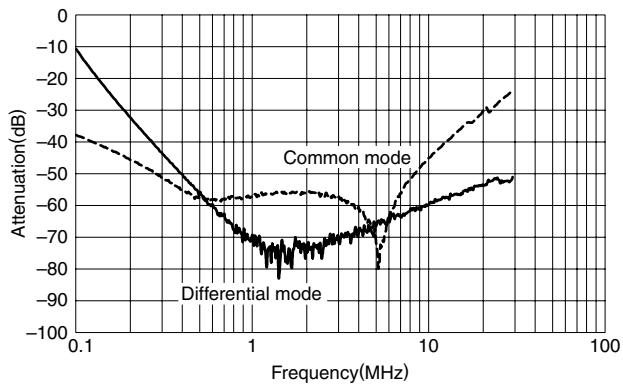

RSEL-2001W/A

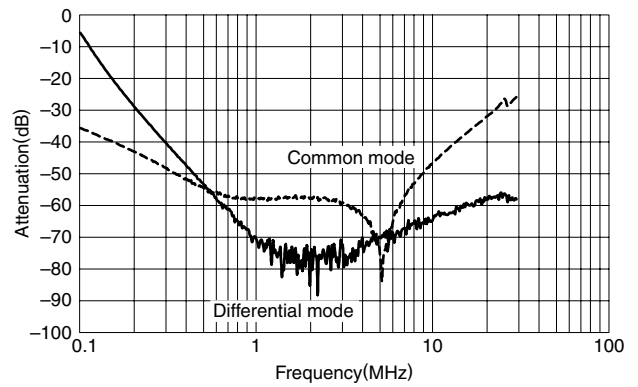

RSEL-2002W/A

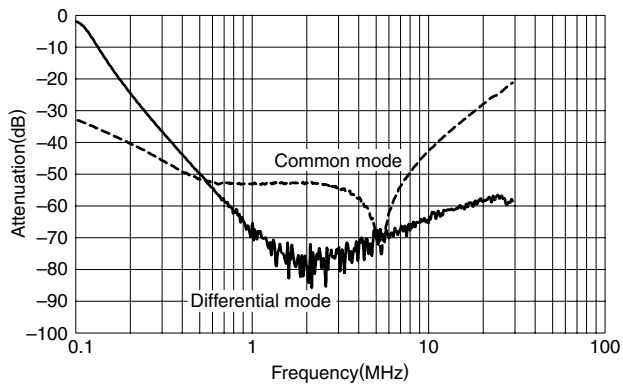

RSEL-2003W/A

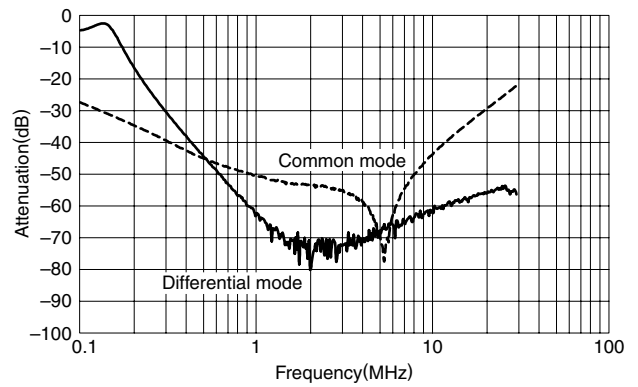

RSEL-2006W/A

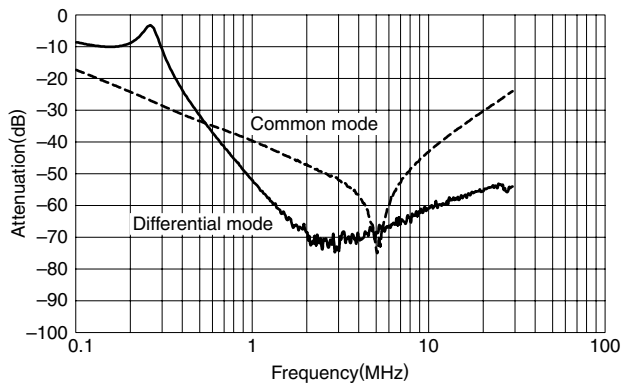

RSEL-20R5WL/AL

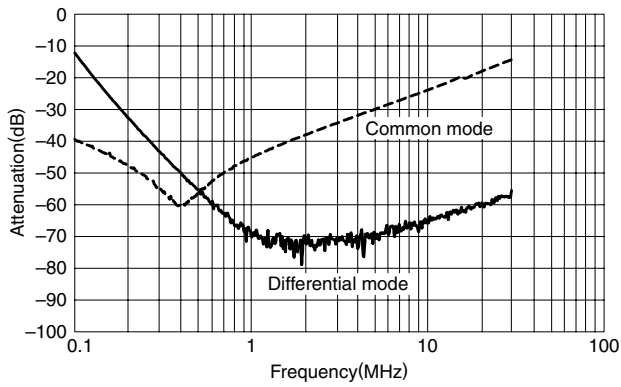

RSEL-2001WL/AL

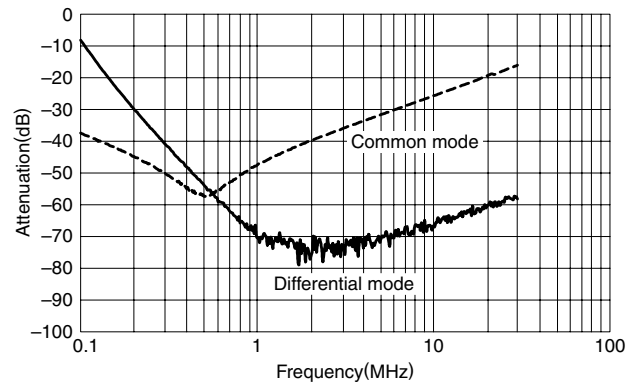

RSEL-2002WL/AL

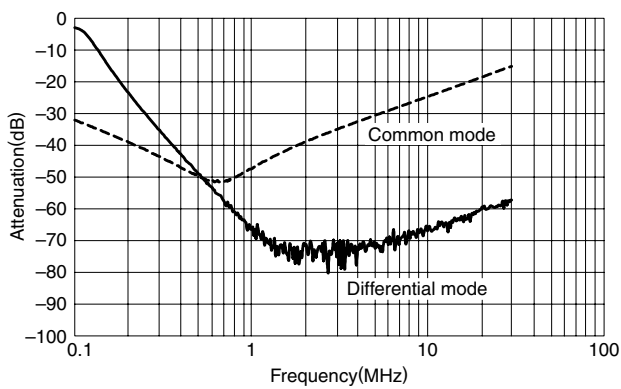

RSEL-2003WL/AL

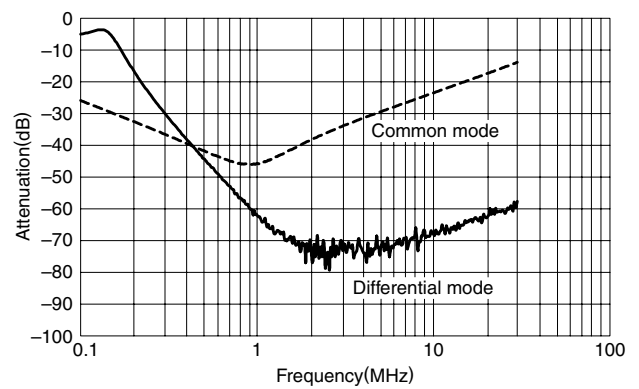

RSEL-2006WL/AL

