

RSHN SERIES

High-Attenuation Type Single-Phase Filter with Various Variations and Functions



FEATURES

- Self-tightening screws and an open/close type cover make wiring work easier.
- 3 to 300A wide range lineup.
- Optional low-leakage current characteristic type and DIN rail installation compatible type are also available.
- Compliant with RoHS directives.

SAFETY STANDARDS

UL1283	File No. E62388 (Up to 30A)
CSA C22.2 No.8	File No. 208777 (Up to 30A)
EN60939	Licence Ref. No. SE/07115-3 (Up to 30A)

PRODUCT IDENTIFICATION

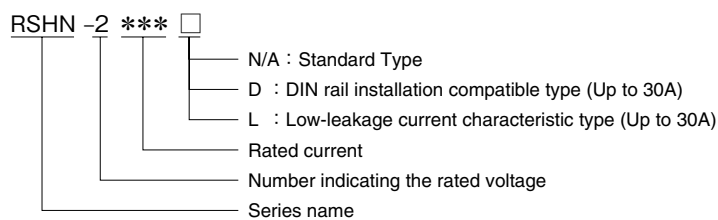

CIRCUIT DIAGRAM

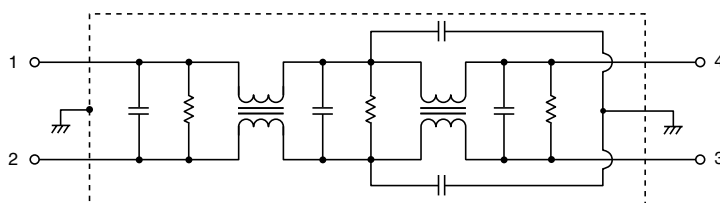

• Conformity to RoHS Directive: This means that, in conformity with EU Directive 2002/95/EC, lead, cadmium, mercury, hexavalent chromium, and specific bromine-based flame retardants, PBB and PBDE, have not been used, except for exempted applications.

• All specifications are subject to change without notice.

ELECTRICAL CHARACTERISTICS

Part No.	Rated voltage (AC/DC)	Rated current (AC/DC)	Withstand voltage	Insulation resistance	Leakage current	Operating temperature range	With derating over	DC resistance (mΩ)	Attenuation frequency range (MHz)		
									Common mode		Differential mode
									at 25dB	at 10dB	at 25dB
RSHN-2003	250V	3A	AC.2500V 60s [Between line to ground]	100MΩ min. [DC.500V/ 1min.]	1.0mA max. [250V/60Hz]	-25 to +85°C	55°C	350 max.	0.1 to 10	-	0.2 to 30
RSHN-2006		6A						140 max.	0.1 to 10	-	0.2 to 30
RSHN-2010		10A						60 max.	0.1 to 30	-	0.3 to 30
RSHN-2016		16A						35 max.	0.2 to 30	-	0.3 to 30
RSHN-2020		20A						22 max.	0.2 to 30	-	0.4 to 30
RSHN-2030		30A						12 max.	0.3 to 30	-	0.6 to 30
RSHN-2040		40A						10 max.	0.2 to 30	-	0.1 to 30
RSHN-2050		50A						8 max.	0.3 to 30	-	0.2 to 30
RSHN-2060		60A						6 max.	0.3 to 30	-	0.3 to 30
RSHN-2080		80A						7 max.	0.2 to 8	-	0.1 to 30
RSHN-2100		100A						6 max.	0.2 to 8	-	0.1 to 30
RSHN-2150		150A						4 max.	0.2 to 7	-	0.1 to 30
RSHN-2200		200A						3 max.	0.4 to 7	-	0.1 to 30
RSHN-2250		250A						2 max.	-	0.4 to 10	0.1 to 30
RSHN-2300	300A	1.5 max.	-	1 to 7	0.1 to 30						

Part No.	Rated voltage (AC/DC)	Rated current (AC/DC)	Withstand voltage	Insulation resistance	Leakage current	Operating temperature range	With derating over	DC resistance (mΩ)	Attenuation frequency range (MHz)	
									Common mode	Differential mode
									at 25dB	at 25dB
RSHN-2003L	250V	3A	AC.2500V 60s [Between line to ground]	100MΩ min. [DC.500V/ 1min.]	100 μA max. [250V/60Hz]	-25 to +85°C	55°C	350 max.	0.2 to 10	0.2 to 30
RSHN-2006L		6A						140 max.	0.2 to 10	0.2 to 30
RSHN-2010L		10A						60 max.	0.3 to 10	0.3 to 30
RSHN-2016L		16A						35 max.	0.3 to 30	0.3 to 30
RSHN-2020L		20A						22 max.	0.4 to 30	0.4 to 30
RSHN-2030L		30A						12 max.	0.6 to 30	0.6 to 30

DERATINGS

RSHN-2003/2006/2010/2016/2020/2030/
2040/2050/2060

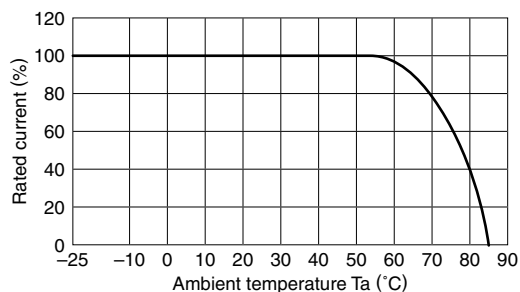

RSHN-2080/2100/2150/2200/2250/2300

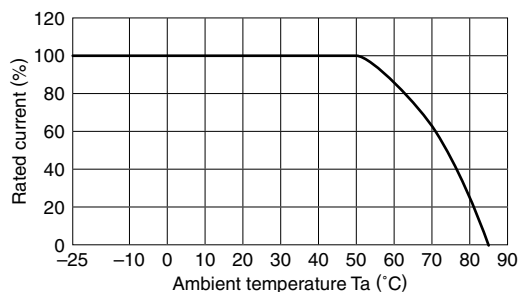

■ SHAPES AND DIMENSIONS

RSHN-2003/2006/2010/2016/2020/2030

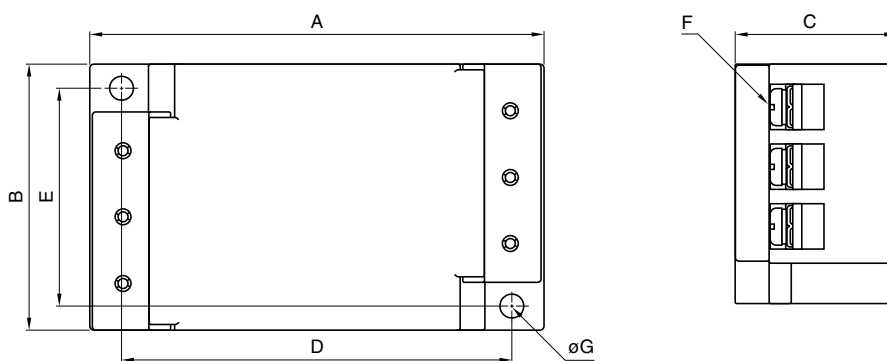

RSHN-2040/2050/2060/2080/2100/2150/2200/2250/2300

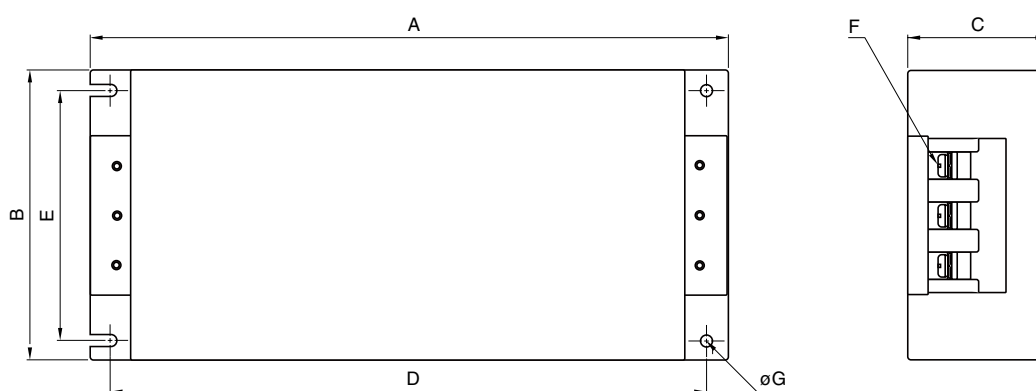

Dimensions in mm

Part No.	A	B	C	D	E	F	ϕG	Recommended clamping torque	
RSHN-2003	98	52	35	86	43	M4	4.5	1.27N · m	
RSHN-2006									
RSHN-2010									
RSHN-2016	127	52	35	115	43	M4			
RSHN-2020									
RSHN-2030									
RSHN-2040	272	100	60	254	82	M5	5.5	2.5N · m	
RSHN-2050									
RSHN-2060									
RSHN-2080	430	161	85	410	135	M8	6.5	7.64N · m	
RSHN-2100									
RSHN-2150									
RSHN-2200	593	195	103	573	169	M10			11.8N · m
RSHN-2250									
RSHN-2300									

RSHN-2003D/2006D/2010D

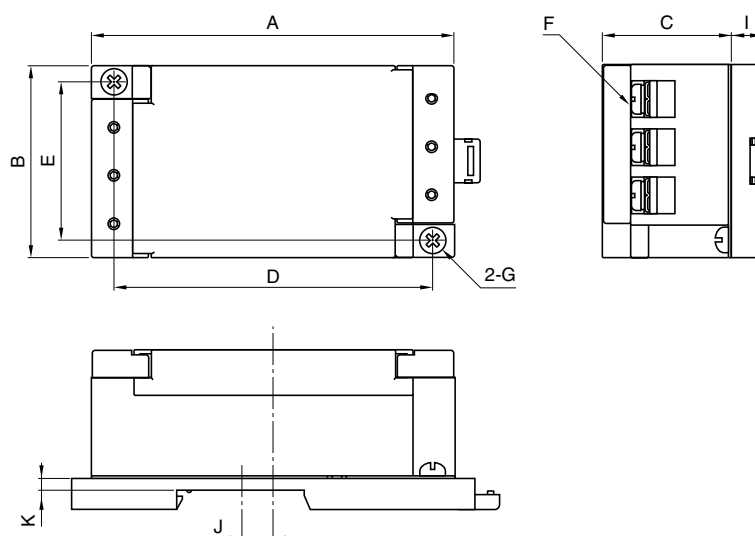

RSHN-2016D/2020D/2030D

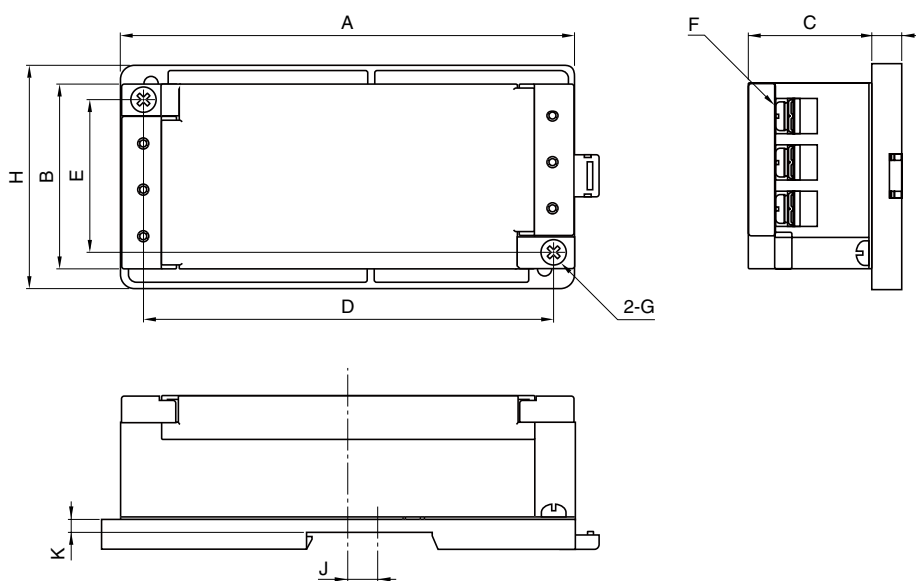

Dimensions in mm

Part No.	A	B	C	D	E	F	G	H	I	J	K
RSHN-2003D	98	52	35	86	43	M4	M4	-	8.4	8.5	3.5
RSHN-2006D											
RSHN-2010D											
RSHN-2016D	127	52	35	115	43	M4	M4	63	8.4	6	3.5
RSHN-2020D											
RSHN-2030D											

ATTENUATION vs. FREQUENCY CHARACTERISTICS

RSHN-2003

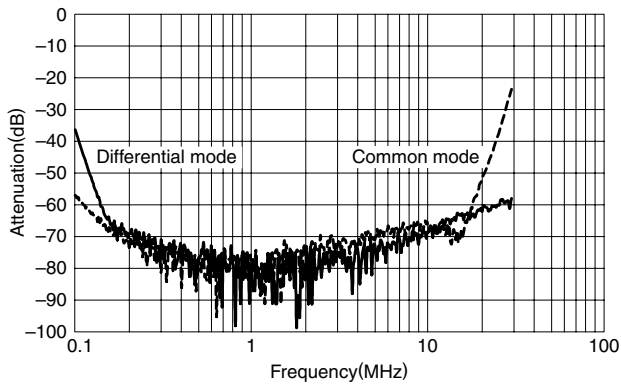

RSHN-2006

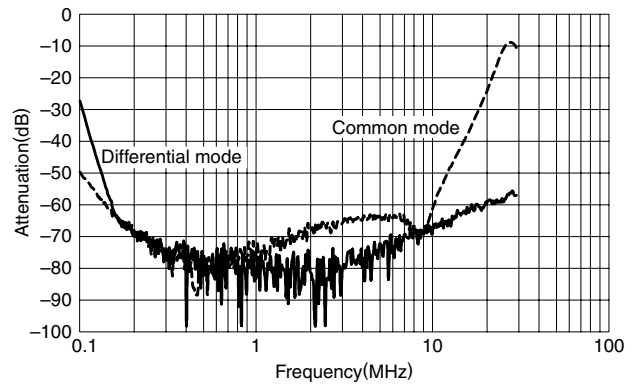

RSHN-2010

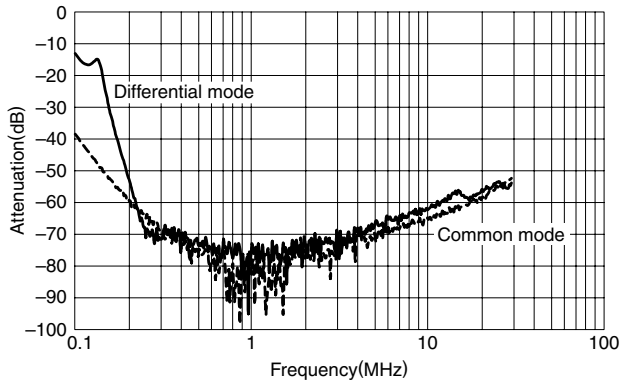

RSHN-2016

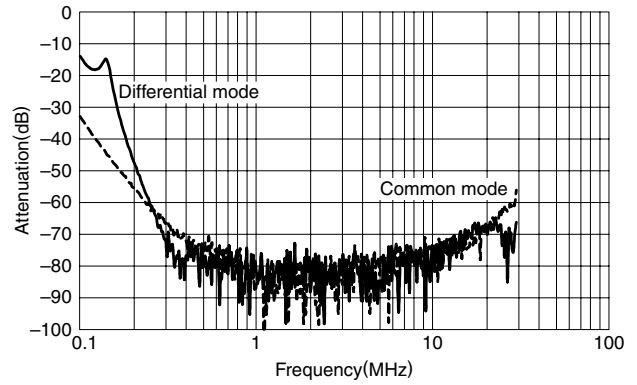

RSHN-2020

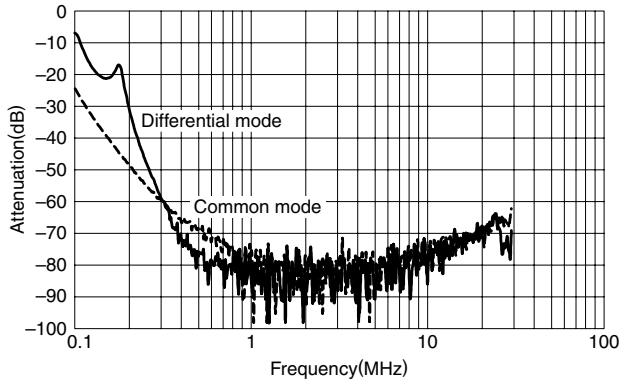

RSHN-2030

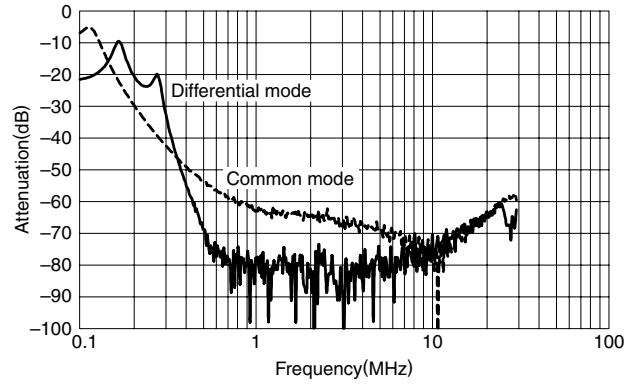

RSHN-2040

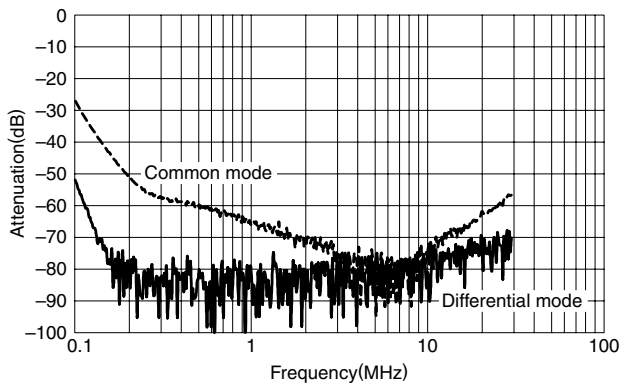

RSHN-2050

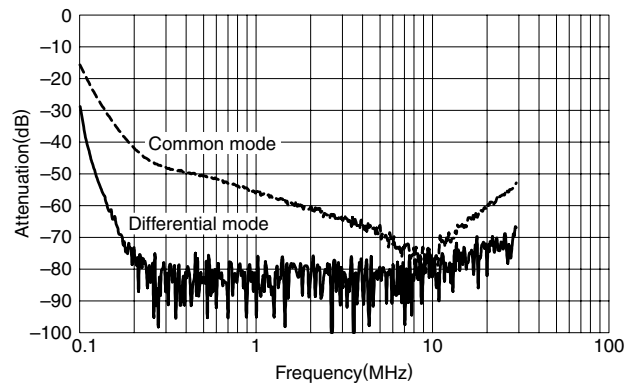

RSHN-2060

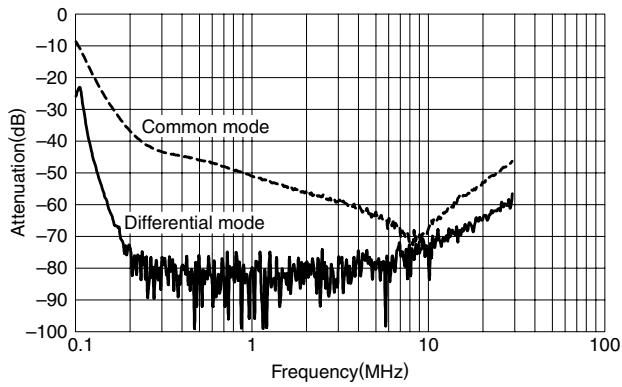

RSHN-2080

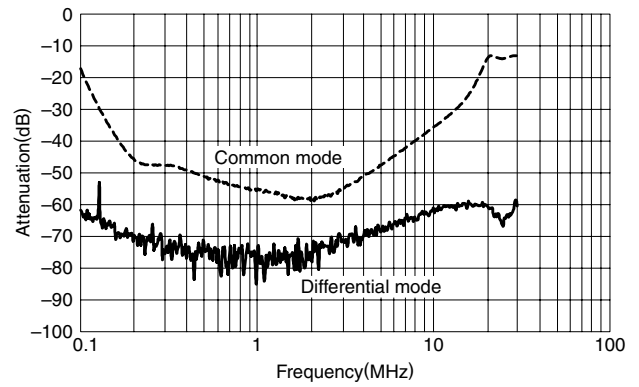

RSHN-2100

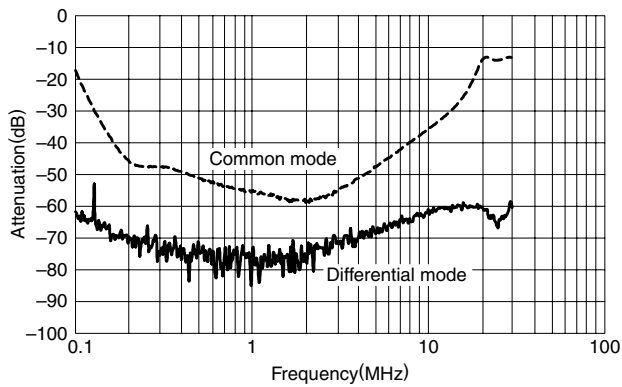

RSHN-2150

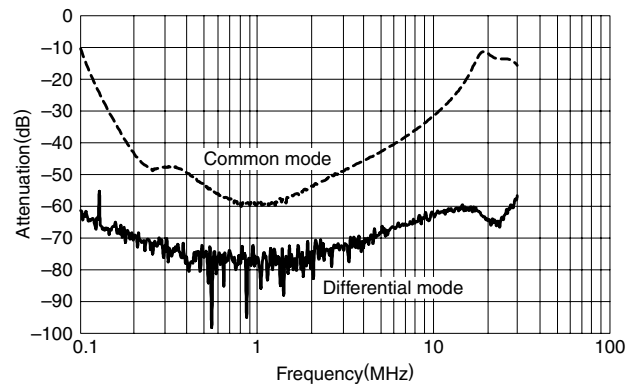

RSHN-2200

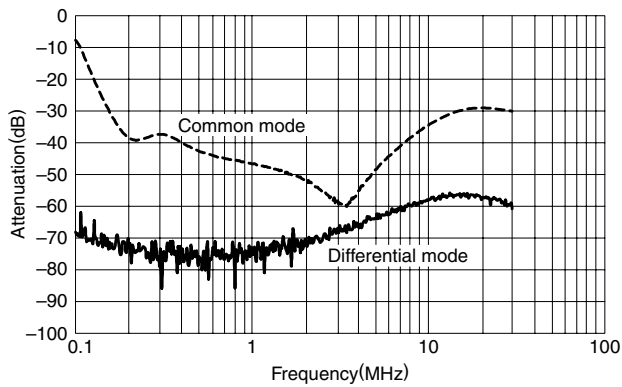

RSHN-2250

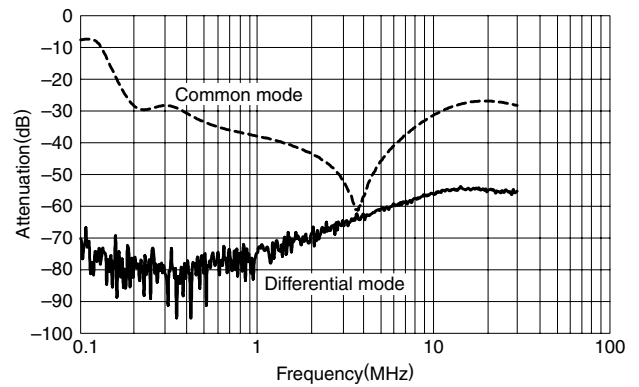

RSHN-2300

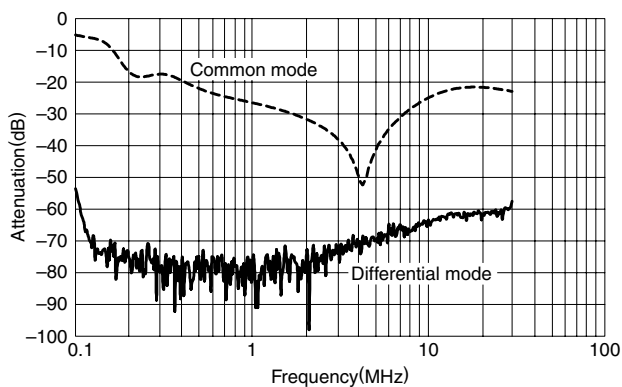

RSHN-2003L

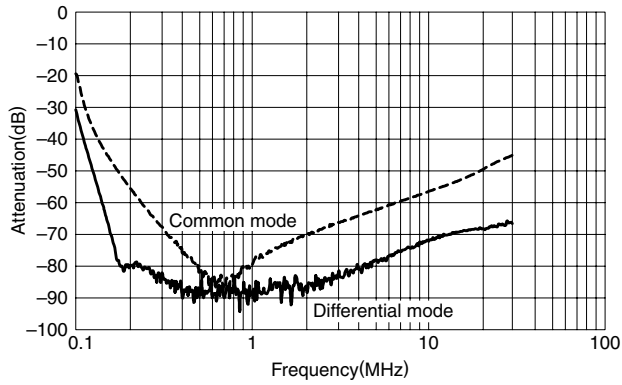

RSHN-2006L

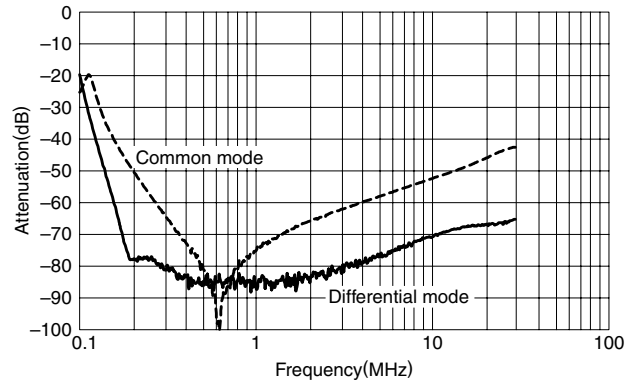

RSHN-2010L

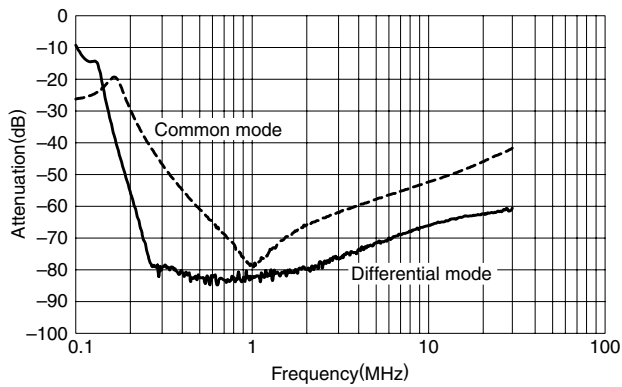

RSHN-2016L

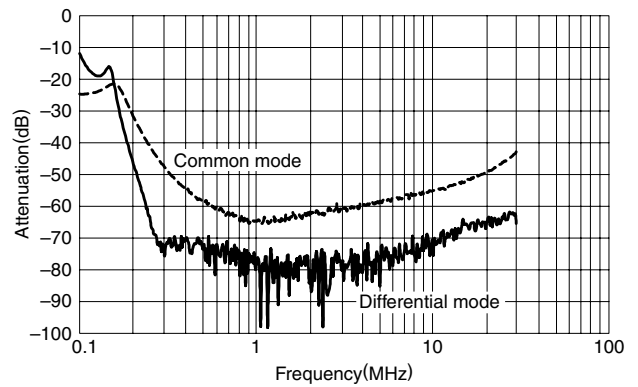

RSHN-2020L

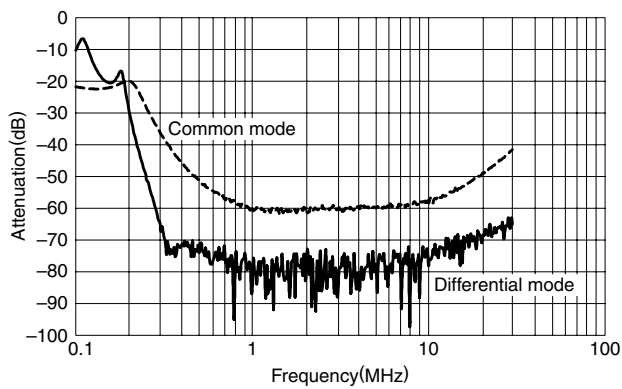

RSHN-2030L

