

## RSMN SERIES

### Compact Multipurpose Type Compatible with High-Voltage Pulse



#### FEATURES

- EMC filter equipped with an amorphous core as the common mode coil core for the RSHN series, which helps prevent device errors, and can also withstand current saturation.
- Self-tightening screws and an open/close type cover make wiring work easier.
- Optional low-leakage characteristic type and DIN rail installation compatible type are also available.
- Compliant with RoHS directives.

#### SAFETY STANDARDS

UL1283	File No. E62388 (Up to 30A)
CSA C22.2 No.8	File No. 208777 (Up to 30A)
EN60939	Licence Ref. No. SE/07115-3 (Up to 30A)

#### PRODUCT IDENTIFICATION

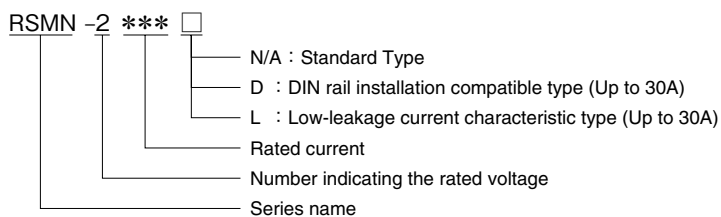

#### CIRCUIT DIAGRAM

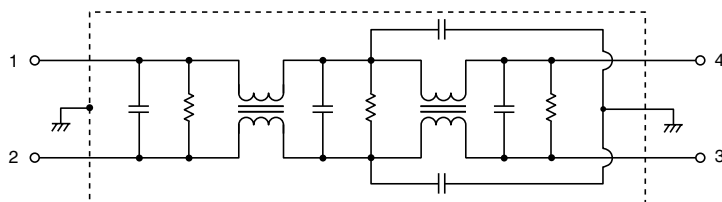

• Conformity to RoHS Directive: This means that, in conformity with EU Directive 2002/95/EC, lead, cadmium, mercury, hexavalent chromium, and specific bromine-based flame retardants, PBB and PBDE, have not been used, except for exempted applications.

• All specifications are subject to change without notice.

## ELECTRICAL CHARACTERISTICS

Part No.	Rated voltage (AC/DC)	Rated current (AC/DC)	Withstand voltage	Insulation resistance	Leakage current	Operating temperature range	With derating over	DC resistance (mΩ)	Attenuation frequency range (MHz)		
									Common mode		Differential mode
									at 25dB		at 25dB
RSMN-2003	250V	3A	AC.2500V 60s [Between line to ground]	100MΩ min. [DC.500V/ 1min.]	1.0mA max. [250V/60Hz]	-25 to +85°C	55°C	350 max.	0.1 to 30	0.1 to 30	
RSMN-2006		6A						140 max.	0.1 to 30	0.2 to 30	
RSMN-2010		10A						60 max.	0.2 to 30	0.2 to 30	
RSMN-2016		16A						35 max.	0.2 to 30	0.3 to 30	
RSMN-2020		20A						22 max.	0.3 to 20	0.4 to 30	
RSMN-2030		30A						12 max.	0.4 to 20	0.6 to 30	
RSMN-2040		40A						10 max.	0.3 to 30	0.1 to 30	
RSMN-2050		50A						8 max.	0.4 to 30	0.3 to 30	
RSMN-2060		60A						6 max.	0.5 to 30	0.3 to 30	

Part No.	Rated voltage (AC/DC)	Rated current (AC/DC)	Withstand voltage	Insulation resistance	Leakage current	Operating temperature range	With derating over	DC resistance (mΩ)	Attenuation frequency range (MHz)		
									Common mode		Differential mode
									at 25dB	at 10dB	at 25dB
RSMN-2003L	250V	3A	AC.2500V 60s [Between line to ground]	100MΩ min. [DC.500V/ 1min.]	100 μA max. [250V/60Hz]	-25 to +85°C	55°C	350 max.	0.3 to 30	-	0.2 to 30
RSMN-2006L		6A						140 max.	0.4 to 20	-	0.2 to 30
RSMN-2010L		10A						60 max.	0.7 to 20	-	0.3 to 30
RSMN-2016L		16A						35 max.	0.7 to 20	-	0.3 to 30
RSMN-2020L		20A						22 max.	-	0.6 to 20	0.3 to 30
RSMN-2030L		30A						12 max.	-	1 to 20	0.4 to 30

## DERATINGS

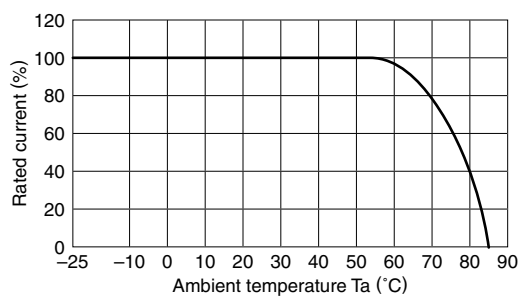

■ SHAPES AND DIMENSIONS

RSMN-2003/2006/2010/2016/2020/2030

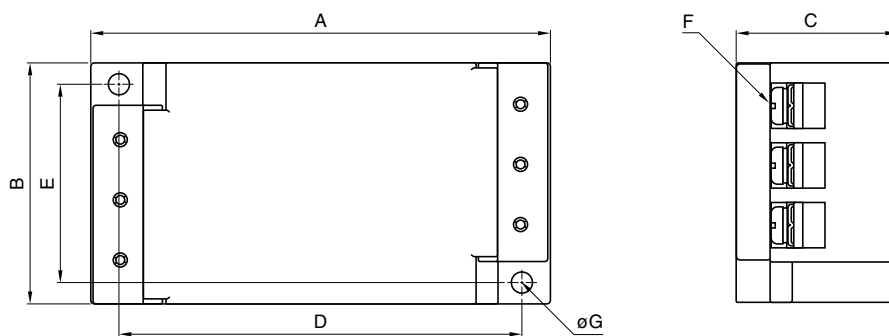

RSMN-2040/2050/2060

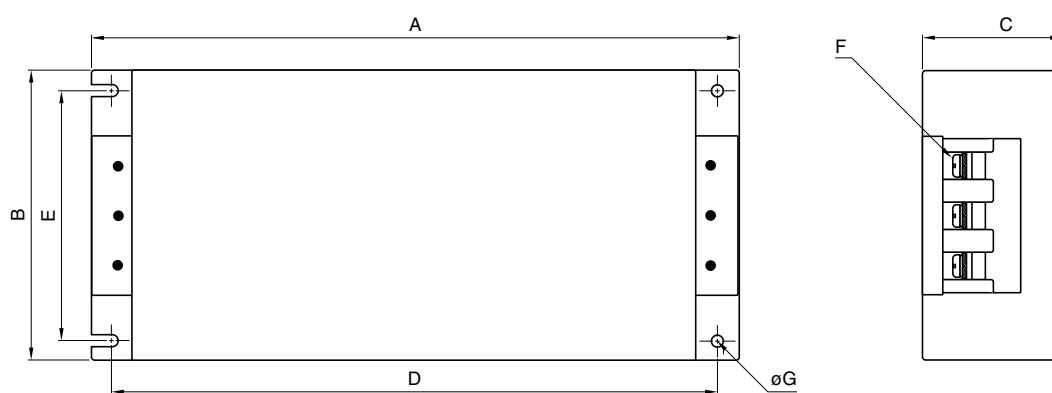

Dimensions in mm

Part No.	A	B	C	D	E	F	$\phi$ G	Recommended clamping torque
RSMN-2003	98	52	35	86	43	M4	4.5	1.27N · m
RSMN-2006								
RSMN-2010								
RSMN-2016	127	52	35	115	43	M4	4.5	
RSMN-2020								
RSMN-2030								
RSMN-2040	272	100	60	254	82	M5	5.5	2.5N · m
RSMN-2050								
RSMN-2060								

RSMN-2003D/2006D/2010D

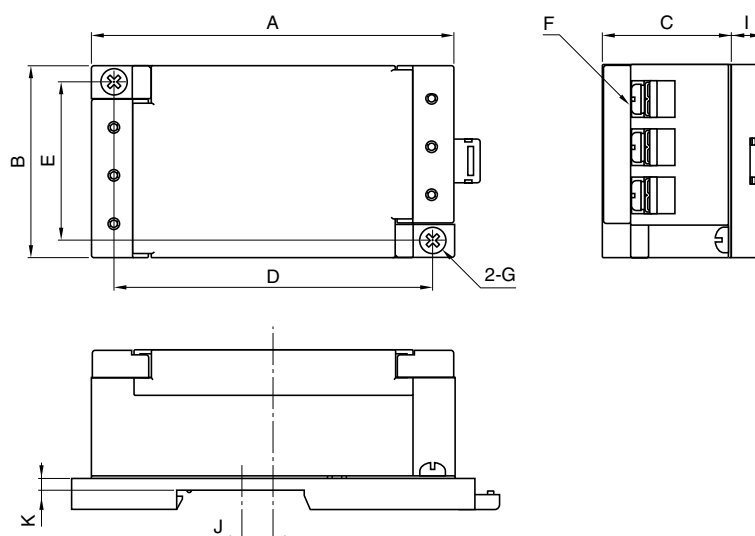

RSMN-2016D/2020D/2030D

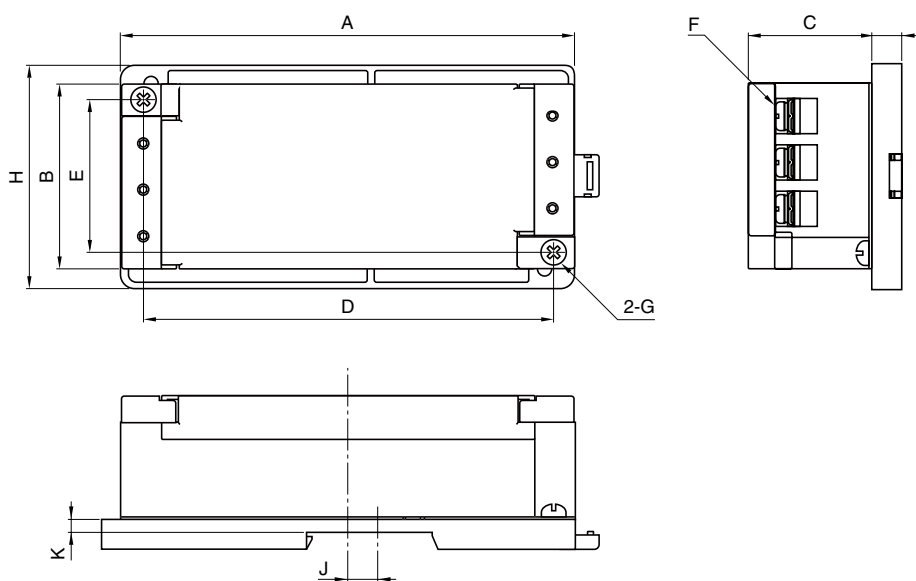

Dimensions in mm

Part No.	A	B	C	D	E	F	G	H	I	J	K
RSMN-2003D	98	52	35	86	43	M4	M4	-	8.4	8.5	3.5
RSMN-2006D											
RSMN-2010D											
RSMN-2016D	127	52	35	115	43	M4	M4	63	8.4	6	3.5
RSMN-2020D											
RSMN-2030D											

**ATTENUATION vs. FREQUENCY CHARACTERISTICS**

RSMN-2003

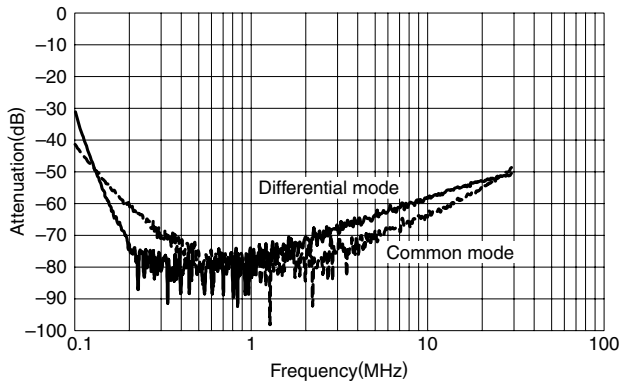

RSMN-2006

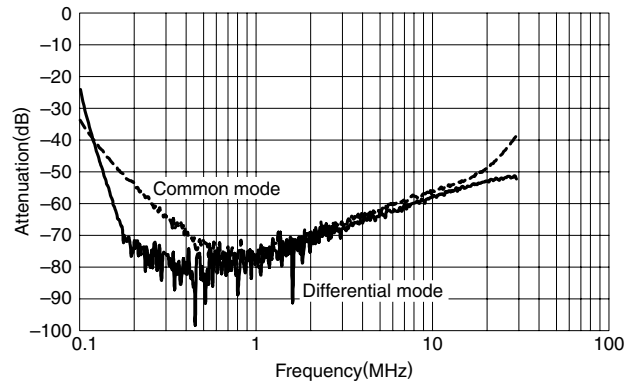

RSMN-2010

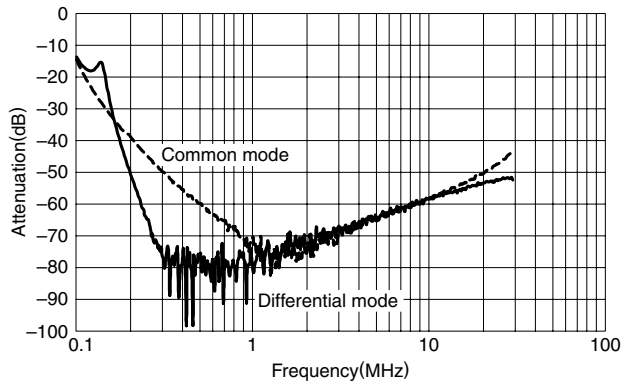

RSMN-2016

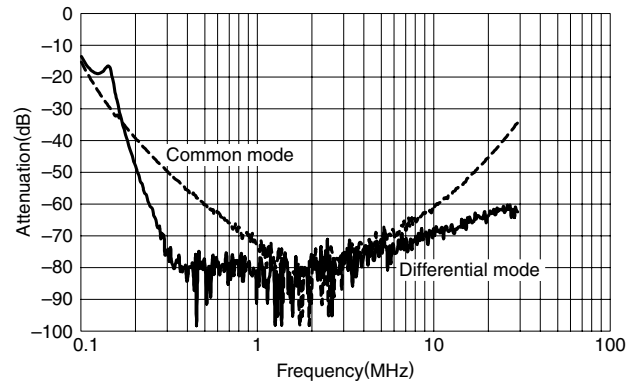

RSMN-2020

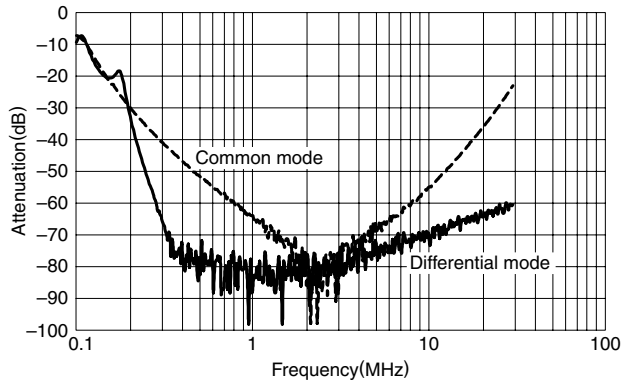

RSMN-2030

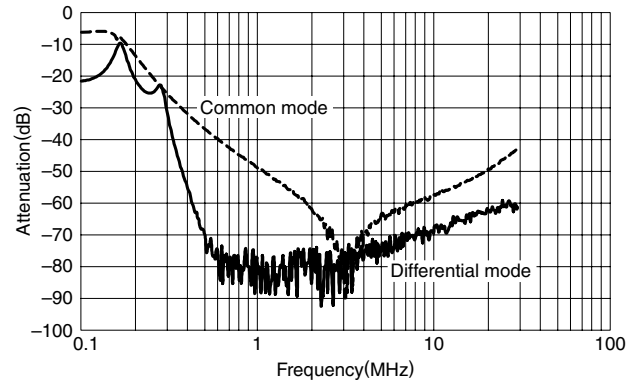

RSMN-2040

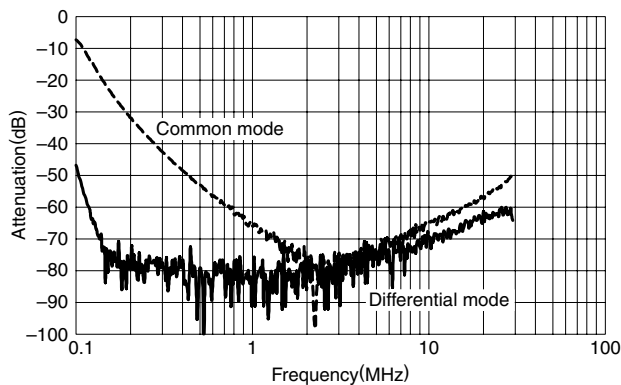

RSMN-2050

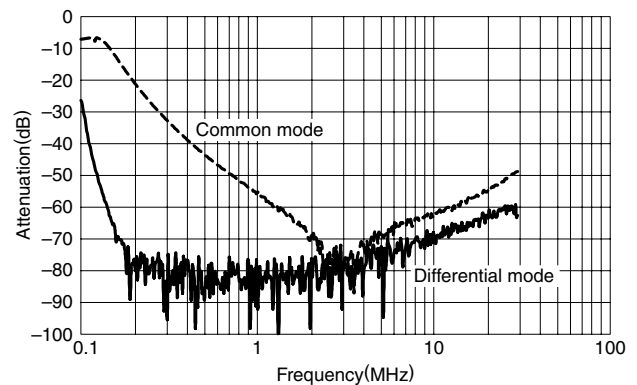

RSMN-2060

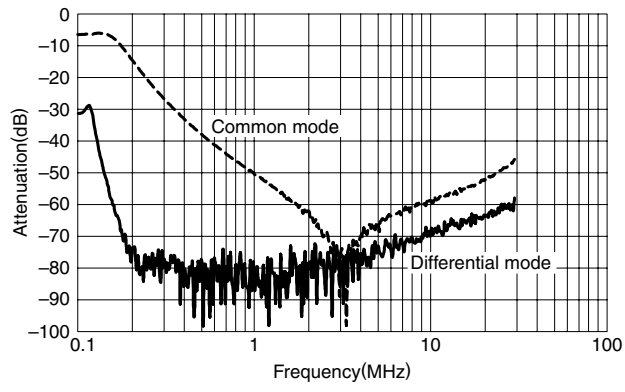

RSMN-2003L

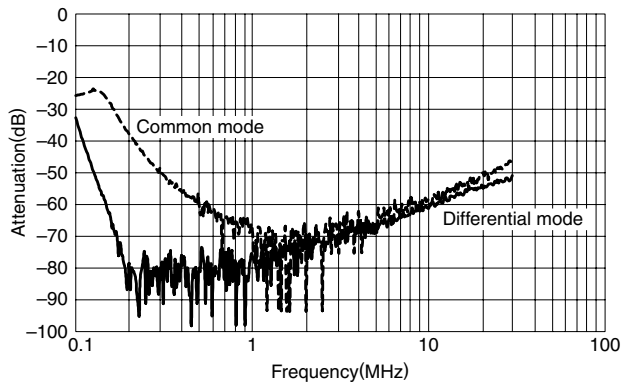

RSMN-2006L

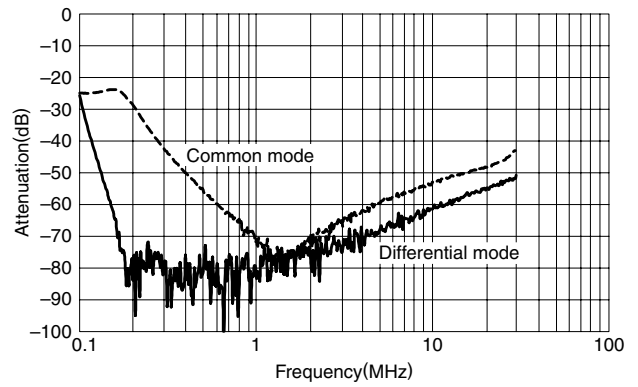

RSMN-2010L

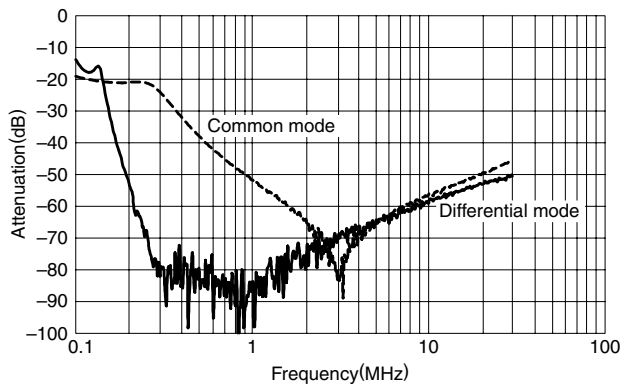

RSMN-2016L

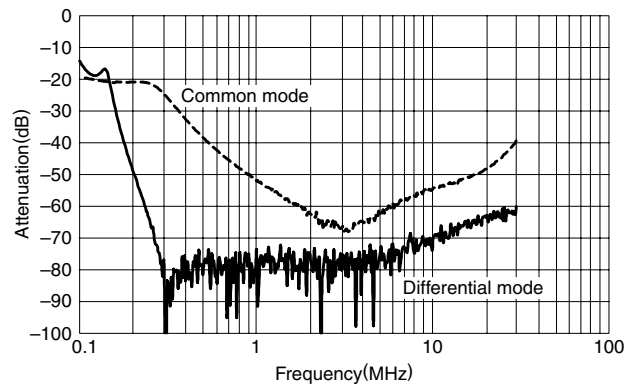

RSMN-2020L

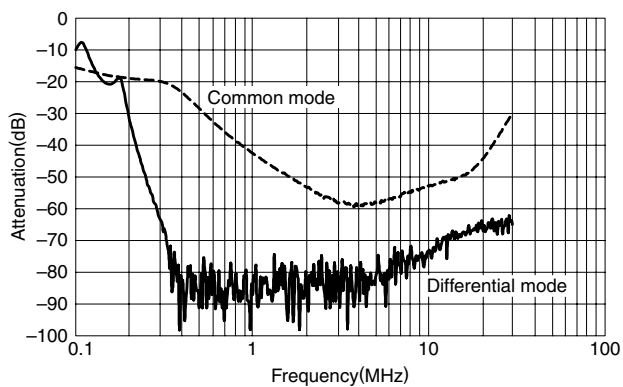

RSMN-2030L

