

THIS DRAWING IS UNPUBLISHED. RELEASED FOR PUBLICATION ,19 .
 © COPYRIGHT 19 BY AMP INCORPORATED. ALL INTERNATIONAL RIGHTS RESERVED.

LOC	DIST	P	F	ZONE	LTR	DESCRIPTION	DATE	APPD
G	14				L	REVISED PER 0L20-0020-97	06MAR97	OKS MJS

METRIC
 DIMENSIONS LISTED IN mm [INCHES]

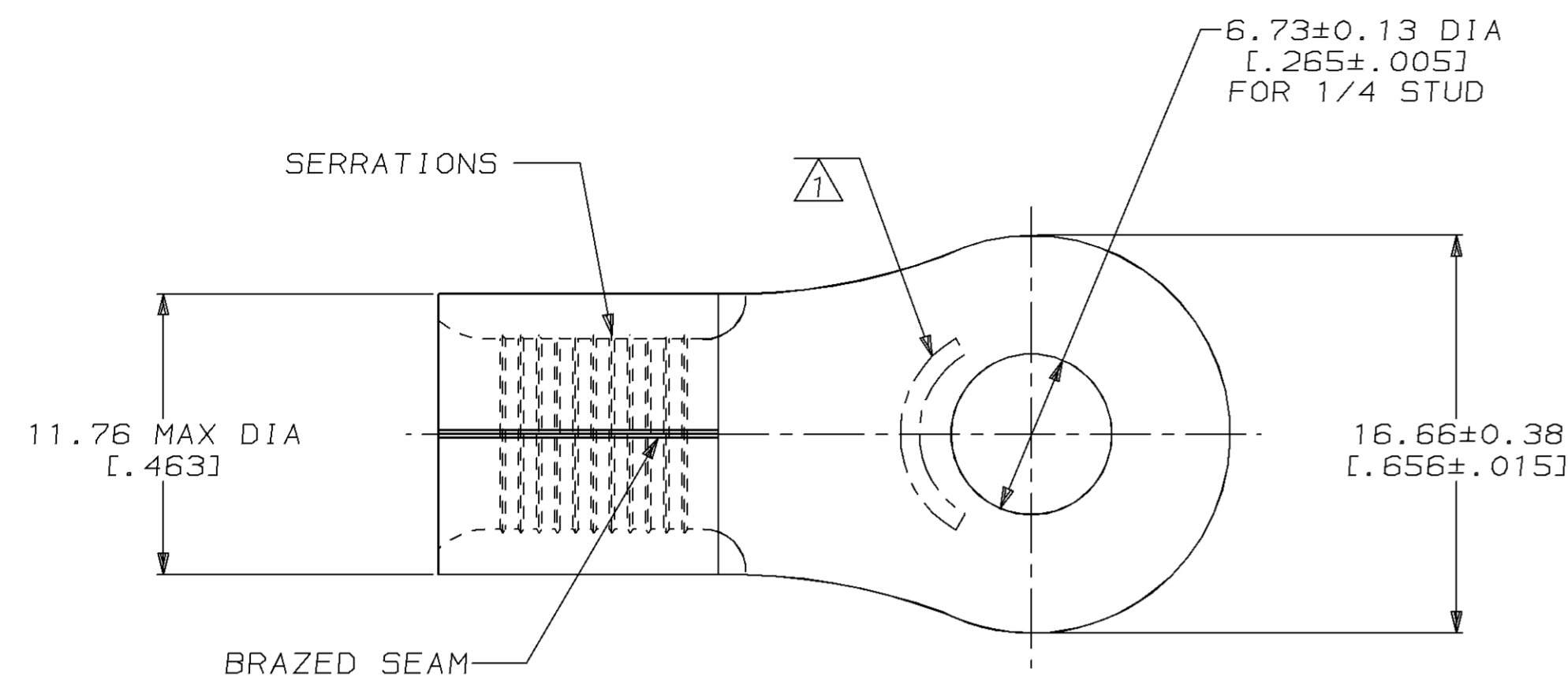

AMP WIRE RANGE	UL E13288 Listed
4 AWG SOLID OR STRANDED	4 AWG STRANDED
SR LR7189 Certified	MILITARY P/N AND CLASS
4 AWG SOLID OR STRANDED	NOT APPLICABLE

1 STAMP AMP 4* APPROX AS SHOWN

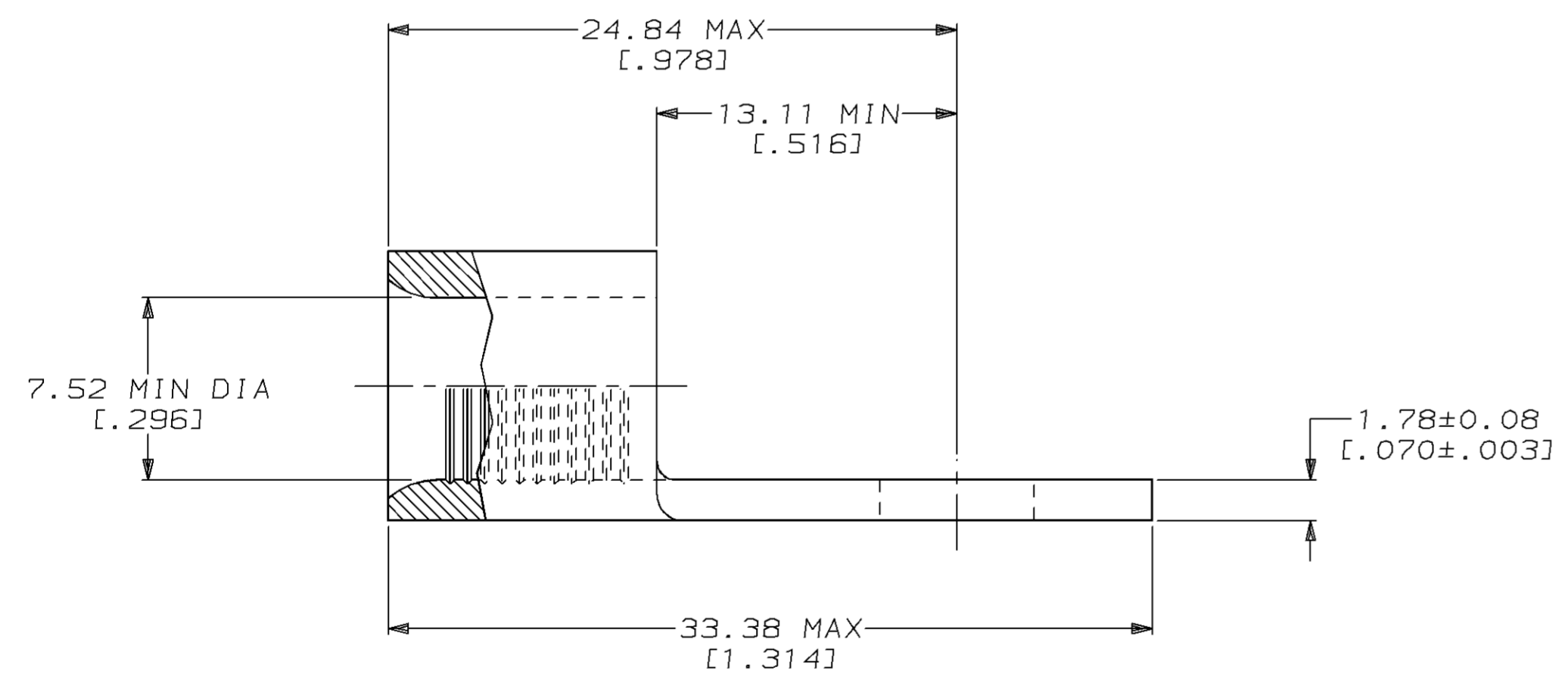

QUANTITY	PACKAGING TYPE	PART NO
25	LOOSE PIECE, BAG	8-33469-5
50	LOOSE PIECE, BOX	8-33469-2
500	ON TAPE, REEL	2-33469-4
500	LOOSE PIECE, BOX	2-33469-2
-	LOOSE PIECE	33469

AMP INCORPORATED
CUSTOMER SERVICE SYSTEMS

FOR ADDITIONAL PRODUCT INFORMATION OR COPIES OF DRAWINGS AND TECHNICAL DOCUMENTS
 PRODUCT INFORMATION CENTER 1-800-522-6752

FOR APPLICATION TOOLING INFORMATION
 TOOLING ASSISTANCE CENTER 1-800-722-1111

FOR ORDER ENTRY
 1-800-526-5142

MAX RECOMMENDED OPERATING TEMPERATURE:
 170°C MAX

VOLTAGE RATING:
 NOT APPLICABLE

WIRE CROSS SECTIONAL AREA RANGE:
 16.8-26.7mm² [33,100-52,600] CIR MILS
 SOLID OR STRANDED

THIS DRAWING IS A CONTROLLED DOCUMENT FOR AMP INCORPORATED. IT IS SUBJECT TO CHANGE AND THE CONTROLLING ENGINEERING ORGANIZATION SHOULD BE CONTACTED FOR THE LATEST REVISION.

DO NOT SCALE PRINT. UNLESS SPECIFIED DIMENSIONS IN mm [INCHES] - TOLERANCES ON :
 2 PLC DEC ± -
 3 PLC DEC ± -
 ANGLES ± -

MATERIAL
 COPPER PER ASTM B-152 ANNEALED

FINISH
 TIN PLATE 0.00254 [0.00100] MIN THK PER MIL-T-10727

DR 3-29-93 TA BRINKMAN
 CHK 3-29-93 DA PATTERSON
 APPD 3-29-93 DE MILLER
 APPD 3-29-93 JL MECKLEY
 PRODUCT SPEC -
 APPLICATION SPEC -
 WEIGHT -

AMP AMP Incorporated
 Harrisburg, PA 17105-3608

NAME
TERMINAL, RING TONGUE, SOLISTRAND™

SIZE CAGE CODE DRAWING NO
 C 00779 C-33469

SCALE 4:1 SHEET 1 OF 1