

Single line low capacitance Transil™ for ESD protection

Features

- Single line low capacitance Transil diode
- Unidirectional ESD protection
- ESD protection > 30 kV (IEC 61000-4-2 contact discharge)
- Breakdown voltage $V_{BR} = 6.1 \text{ V min.}$
- Low diode capacitance (22 pF @ 0 V)
- Low leakage current (< 100 nA @ 3 V)
- Very small PCB area (0.6 mm²)
- RoHS compliant

Benefits

- High ESD protection level
- High integration
- Suitable for high density boards

Complies with the following standards:

- IEC 61000-4-2 level 4
 - 15 kV (air discharge)
 - 8 kV (contact discharge)
- MIL STD 883G - Method 3015-7: class 3B
 - HBM (Human body model)

Applications

Where transient overvoltage protection in ESD sensitive equipment is required, such as:

- Computers
- Printers
- Communication systems
- Cellular phone handsets and accessories
- Video equipment



Figure 1. Functional diagram

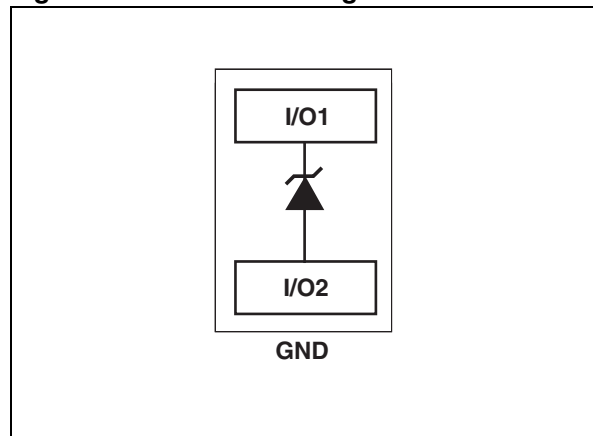

Description

The ESDALC6V1-1M2 is a unidirectional single line TVS diode designed to protect the data lines or other I/O ports against ESD transients.

The device is ideal for applications where both reduced line capacitance and board space saving are required.

TM: Transil is a trademark of STMicroelectronics

1 Characteristics

Table 1. Absolute maximum ratings ($T_{amb} = 25\text{ }^{\circ}\text{C}$)

Symbol	Parameter	Value	Unit
V_{PP}	ESD discharge - IEC 61000-4-2 contact discharge	± 30	kV
P_{PP}	Peak pulse power dissipation (8/20 μs) ⁽¹⁾	50	W
I_{PP}	Repetitive peak pulse current (8/20 μs)	6	A
T_j	Junction temperature	125	$^{\circ}\text{C}$
T_{stg}	Storage temperature	- 55 to +150	$^{\circ}\text{C}$
T_L	Maximum lead temperature for soldering during 10 s at 5 mm for case	260	$^{\circ}\text{C}$
T_{OP}	Operating temperature range	- 40 to + 125	$^{\circ}\text{C}$

1. For a surge greater than the maximum values, the diode will fail in short-circuit

Table 2. Electrical characteristics

Symbol	Parameter								
V_{RM}	Stand-of voltage								
V_{BR}	Breakdown voltage								
V_{CL}	Clamping voltage								
I_{RM}	Leakage current @ V_{RM}								
I_{PP}	Peak pulse current								
αT	Voltage temperature coefficient								
V_F	Forward voltage drop								
Order code	$V_{BR} @ I_R$			$I_{RM} @ V_{RM}$		R_D	$V_F @ 10\text{ mA}$	αT	$C @ 0\text{ V}$
	Vmin	Vmax	mA	nA max	V	Ω typ	V max	10-4/ $^{\circ}\text{C}$ max	pF typ
ESDALC6V1-1M2	6.1	7.2	1	100	3	0.5	1	4.5	22

Figure 2. Peak power dissipation versus initial junction temperature

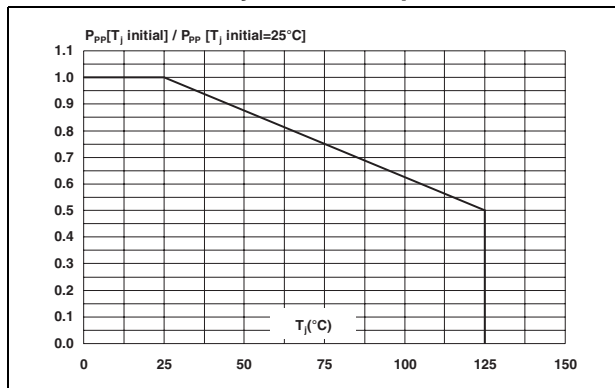

Figure 3. Peak pulse power versus exponential pulse duration

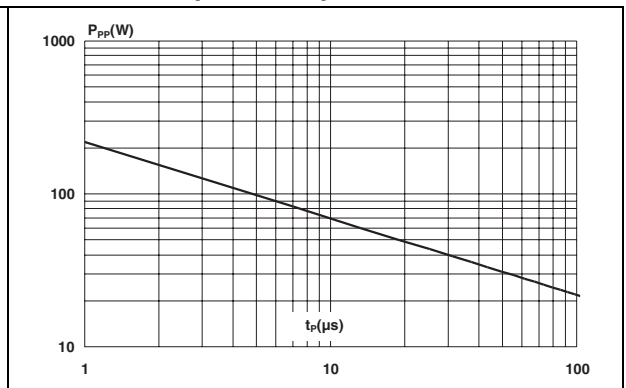

Figure 4. Clamping voltage versus peak pulse current, rectangular waveform

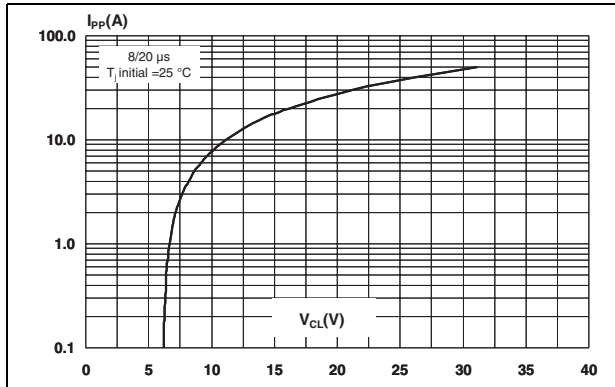

Figure 5. Forward voltage drop versus peak forward current (typical values)

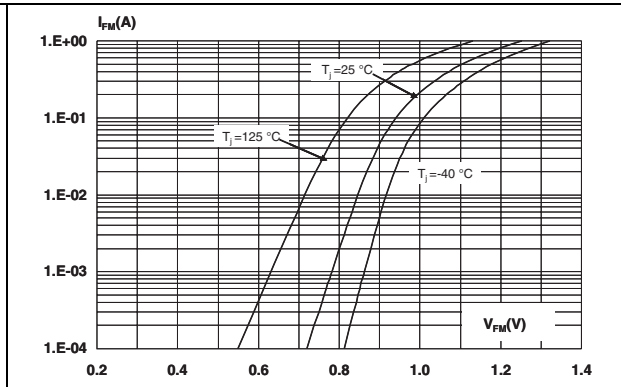

Figure 6. Capacitance versus reverse applied voltage (typical values)

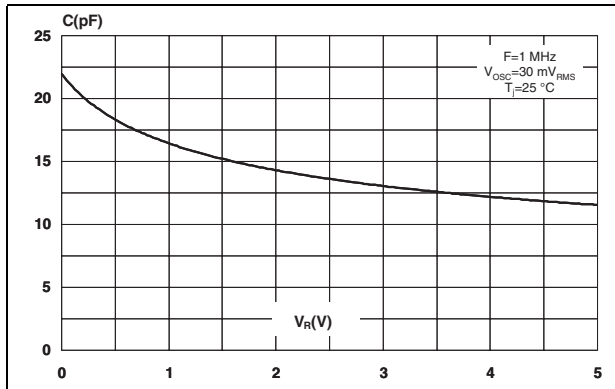

Figure 7. Relative variation of the leakage current versus junction temperature (typical values)

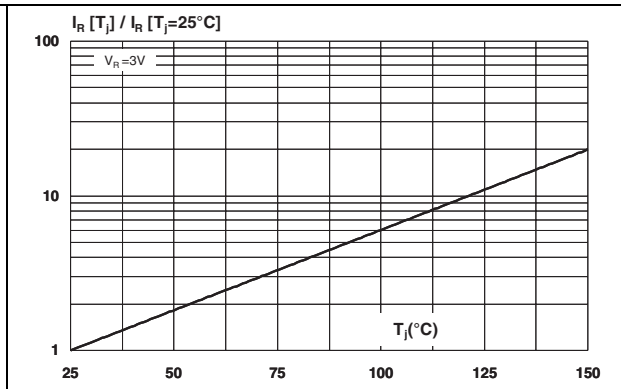

Figure 8. ESD response to IEC 61000-4-2 (+15 kV air discharge) on each channel

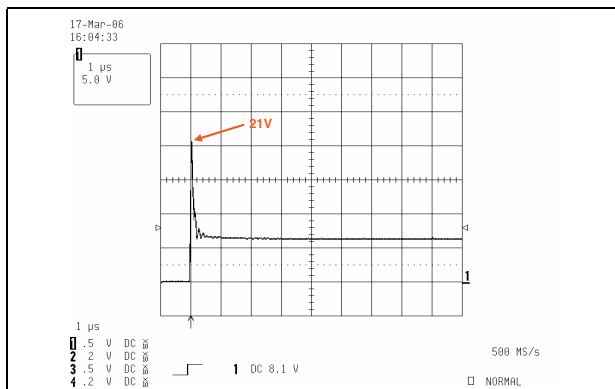

Figure 9. ESD response to IEC 61000-4-2 (-15 kV air discharge) on each channel

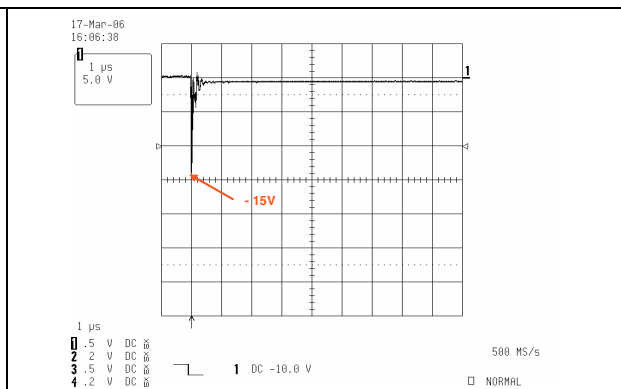
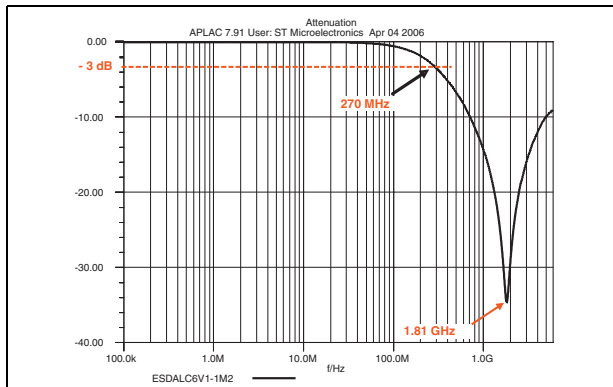
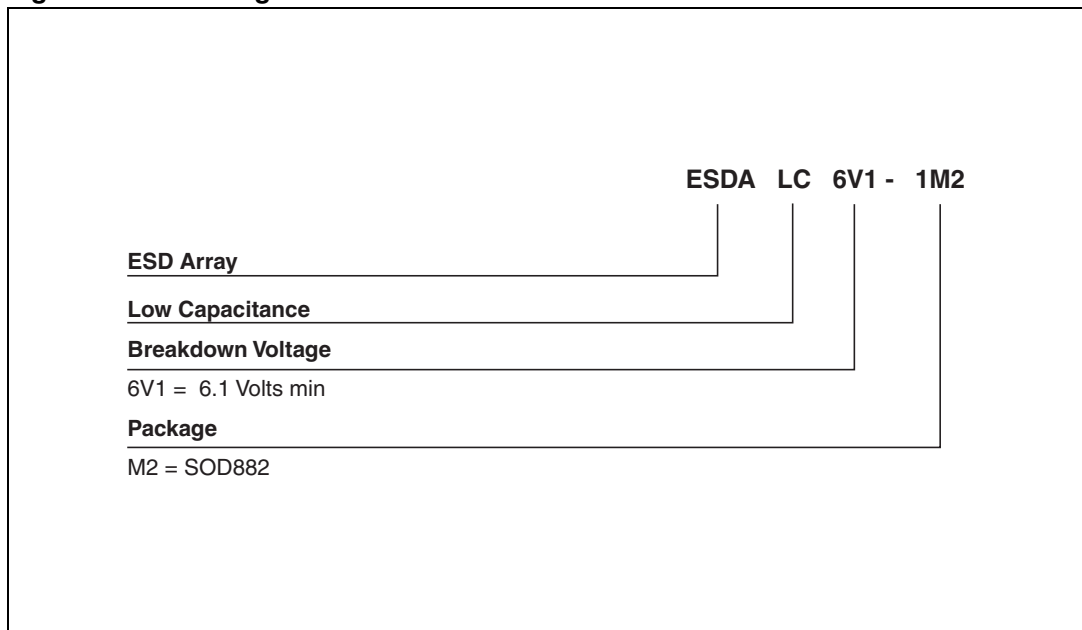

Figure 10. S21 attenuation measurement result



2 Ordering information scheme

Figure 11. Ordering information scheme



3 Package information

- Epoxy meets UL94, V0

In order to meet environmental requirements, ST (also) offers these devices in ECOPACK® packages. ECOPACK® packages are Lead-free. The category of second level Interconnect is marked on the inner box label, in compliance with JEDEC Standard JESD97. The maximum ratings related to soldering conditions are also marked on the inner box label.

ECOPACK is an ST trademark. ECOPACK specifications are available at: www.st.com.

Table 3. SOD882 dimensions

Ref	Dimensions					
	Millimetres			Inches		
	Min	Typ	Max	Min	Typ	Max
A	0.40	0.47	0.50	0.016	0.019	0.020
A1	0.00		0.05	0.000		0.002
b1	0.20	0.25	0.30	0.008	0.010	0.012
b2	0.20	0.25	0.30	0.008	0.010	0.012
D		1.00			0.039	
E		0.60			0.024	
e		0.65			0.026	
L1	0.45	0.50	0.55	0.018	0.020	0.022
L2	0.45	0.50	0.55	0.018	0.020	0.022

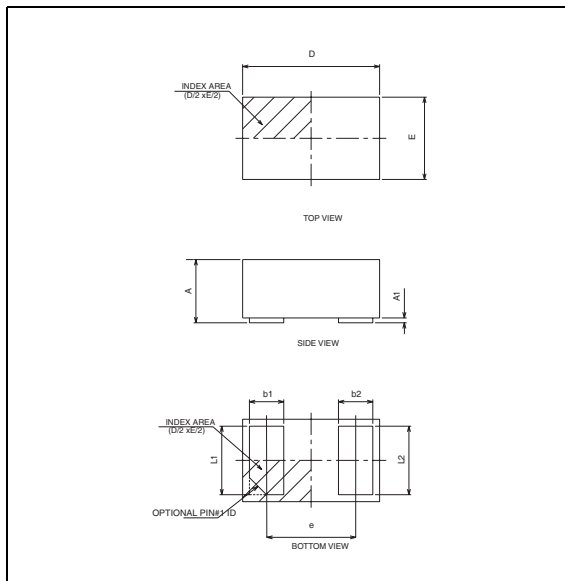

Note: Product marking may be rotated by 90° for assembly plant differentiation. In no case should this product marking be used to orient the component for its placement on a PCB. Only pin 1 mark is to be used for this purpose.

Figure 12. Footprint (dimensions in mm) Figure 13. Marking

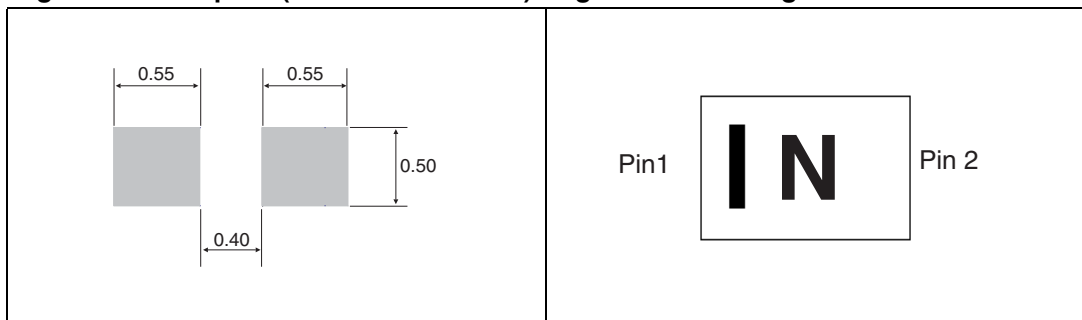
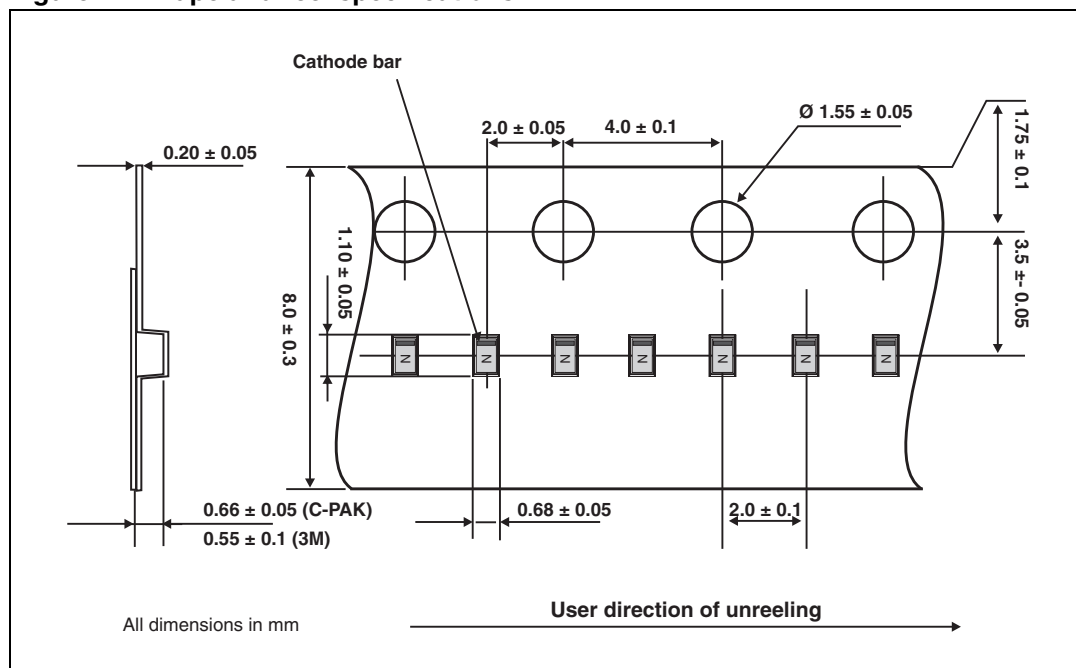

Figure 14. Tape and reel specifications



4 Recommendation on PCB assembly

4.1 Stencil opening design

1. General recommendation on stencil opening design
 - a) Stencil opening dimensions: L (Length), W (Width), T (Thickness).

Figure 15. Stencil opening dimensions

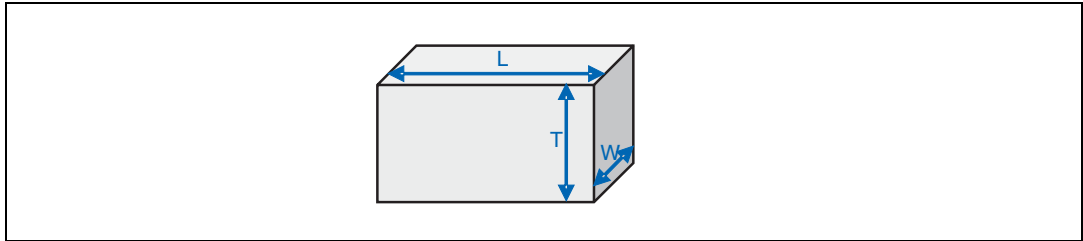

- b) General design rule
 - Stencil thickness (T) = 75 ~ 125 μm
 - Aspect Ratio = $\frac{W}{T} \geq 1.5$
 - Aspect Area = $\frac{L \times W}{2T(L + W)} \geq 0.66$

2. Reference design
 - a) Stencil opening thickness: 100 μm
 - b) Stencil opening for leads: Opening to footprint ratio - between 60% and 65%.

Figure 16. Recommended stencil windows position

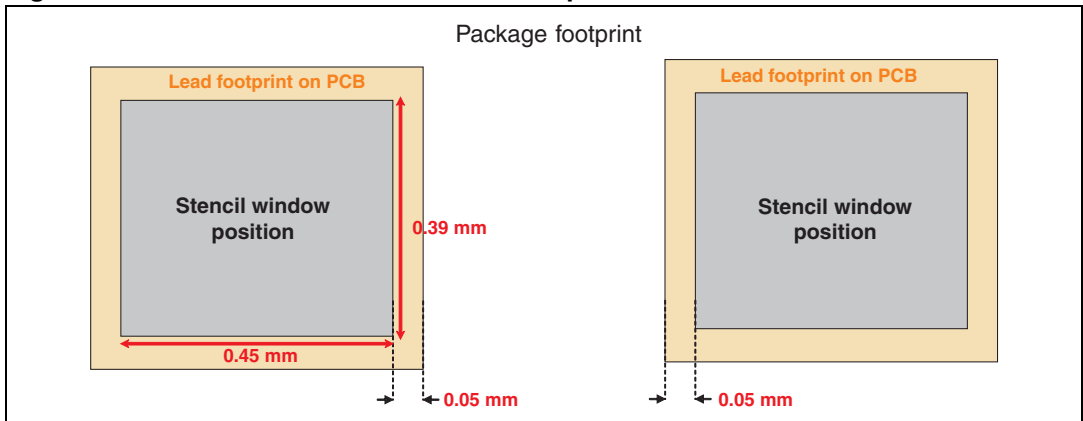

4.2 Solder paste

1. Halide-free flux qualification ROL0 according to ANSI/J-STD-004.
2. "No clean" solder paste is recommended.
3. Offers a high tack force to resist component movement during high speed
4. Solder paste with fine particles: powder particle size is 20-45 μm .

4.3 Placement

1. Manual positioning is not recommended.
2. It is recommended to use the lead recognition capabilities of the placement system, not the outline centering
3. Standard tolerance of ± 0.05 mm is recommended.
4. 3.5 N placement force is recommended. Too much placement force can lead to squeezed out solder paste and cause solder joints to short. Too low placement force can lead to insufficient contact between package and solder paste that could cause open solder joints or badly centered packages.
5. To improve the package placement accuracy, a bottom side optical control should be performed with a high resolution tool.
6. For assembly, a perfect supporting of the PCB (all the more on flexible PCB) is recommended during solder paste printing, pick and place and reflow soldering by using optimized tools.

4.4 PCB design preference

1. To control the solder paste amount, the closed via is recommended instead of open vias.
2. The position of tracks and open vias in the solder area should be well balanced. The symmetrical layout is recommended, in case any tilt phenomena caused by asymmetrical solder paste amount due to the solder flow away.

4.5 Reflow profile

Figure 17. ST ECOPACK® recommended soldering reflow profile for PCB mounting

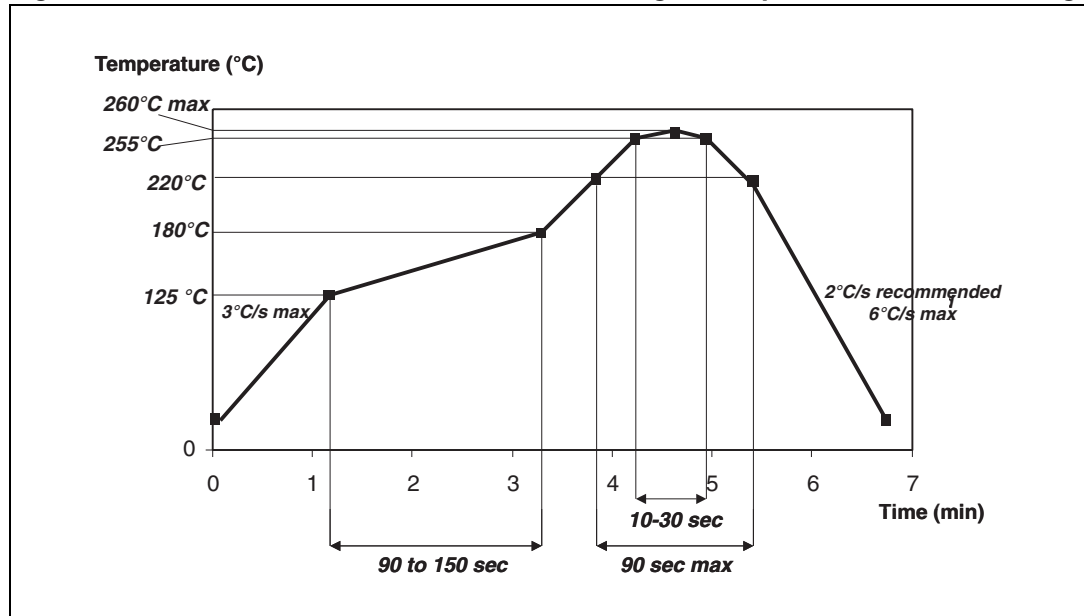

Note: Minimize air convection currents in the reflow oven to avoid component movement.

5 Ordering information

Table 4. Ordering information

Order code	Marking	Package	Weight	Base qty	Delivery mode
ESDALC6V1-1M2	N ⁽¹⁾	SOD882	0.92 mg	3000	Tape and reel

1. The marking can be rotated by 90° to differentiate assembly location

6 Revision history

Table 5. Document revision history

Date	Revision	Changes
23-May-2006	1	Initial release
16-Jun-2006	2	Updated tape and reel illustration (Figure 13).
11-Oct-2006	3	Corrected formatting errors on page 1. No technical changes.
10-May-2007	4	Updated <i>Functional diagram</i> to single diode. Added <i>Section 4: Recommendation on PCB assembly</i> .
26-Nov-2007	5	Corrected <i>2: Ordering information scheme</i> . Updated <i>Figure 14: Tape and reel specifications</i> . Added <i>Figure 16: Recommended stencil windows position</i> . Reformatted to current standards.

Please Read Carefully:

Information in this document is provided solely in connection with ST products. STMicroelectronics NV and its subsidiaries ("ST") reserve the right to make changes, corrections, modifications or improvements, to this document, and the products and services described herein at any time, without notice.

All ST products are sold pursuant to ST's terms and conditions of sale.

Purchasers are solely responsible for the choice, selection and use of the ST products and services described herein, and ST assumes no liability whatsoever relating to the choice, selection or use of the ST products and services described herein.

No license, express or implied, by estoppel or otherwise, to any intellectual property rights is granted under this document. If any part of this document refers to any third party products or services it shall not be deemed a license grant by ST for the use of such third party products or services, or any intellectual property contained therein or considered as a warranty covering the use in any manner whatsoever of such third party products or services or any intellectual property contained therein.

UNLESS OTHERWISE SET FORTH IN ST'S TERMS AND CONDITIONS OF SALE ST DISCLAIMS ANY EXPRESS OR IMPLIED WARRANTY WITH RESPECT TO THE USE AND/OR SALE OF ST PRODUCTS INCLUDING WITHOUT LIMITATION IMPLIED WARRANTIES OF MERCHANTABILITY, FITNESS FOR A PARTICULAR PURPOSE (AND THEIR EQUIVALENTS UNDER THE LAWS OF ANY JURISDICTION), OR INFRINGEMENT OF ANY PATENT, COPYRIGHT OR OTHER INTELLECTUAL PROPERTY RIGHT.

UNLESS EXPRESSLY APPROVED IN WRITING BY AN AUTHORIZED ST REPRESENTATIVE, ST PRODUCTS ARE NOT RECOMMENDED, AUTHORIZED OR WARRANTED FOR USE IN MILITARY, AIR CRAFT, SPACE, LIFE SAVING, OR LIFE SUSTAINING APPLICATIONS, NOR IN PRODUCTS OR SYSTEMS WHERE FAILURE OR MALFUNCTION MAY RESULT IN PERSONAL INJURY, DEATH, OR SEVERE PROPERTY OR ENVIRONMENTAL DAMAGE. ST PRODUCTS WHICH ARE NOT SPECIFIED AS "AUTOMOTIVE GRADE" MAY ONLY BE USED IN AUTOMOTIVE APPLICATIONS AT USER'S OWN RISK.

Resale of ST products with provisions different from the statements and/or technical features set forth in this document shall immediately void any warranty granted by ST for the ST product or service described herein and shall not create or extend in any manner whatsoever, any liability of ST.

ST and the ST logo are trademarks or registered trademarks of ST in various countries.

Information in this document supersedes and replaces all information previously supplied.

The ST logo is a registered trademark of STMicroelectronics. All other names are the property of their respective owners.

© 2007 STMicroelectronics - All rights reserved

STMicroelectronics group of companies

Australia - Belgium - Brazil - Canada - China - Czech Republic - Finland - France - Germany - Hong Kong - India - Israel - Italy - Japan - Malaysia - Malta - Morocco - Singapore - Spain - Sweden - Switzerland - United Kingdom - United States of America

www.st.com