

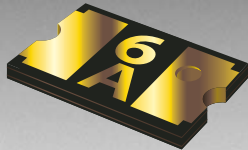



*ROHS COMPLIANT



BOURNS®

Features

- Fast tripping resettable circuit protection
- Surface mount packaging for automated assembly
- Small footprint size (1210)
- RoHS compliant*
- Agency recognition*:   

Applications

- Game consoles
- PC motherboards
- USB current-limiting compliance
- IEEE 1394 ports
- Mobile phones
- Digital cameras

MF-USMF Series - PTC Resettable Fuses

Electrical Characteristics

Model	V max. Volts	I max. Amps	I _{hold}	I _{trip}	Resistance		Max. Time To Trip		Tripped Power Dissipation
			Amperes at 23 °C		Ohms at 23 °C		Amperes at 23 °C	Seconds at 23 °C	Watts at 23 °C
			Hold	Trip	R _{Min.}	R _{1Max.}			Typ.
MF-USMF005	30	10	0.05	0.15	2.800	50.000	0.25	1.50	0.6
MF-USMF010	30	10	0.10	0.30	0.800	15.000	0.50	0.60	0.6
MF-USMF020	30	10	0.20	0.40	0.400	5.000	8.00	0.02	0.6
MF-USMF035	6	40	0.35	0.75	0.200	1.300	8.00	0.20	0.6
MF-USMF050	13.2	40	0.50	1.00	0.180	0.900	8.00	0.10	0.6
MF-USMF075	6	40	0.75	1.50	0.070	0.450	8.00	0.10	0.6
MF-USMF110	6	40	1.10	2.20	0.050	0.210	5.00	1.00	0.6
MF-USMF150	6	40	1.50	3.00	0.030	0.110	5.00	5.00	0.6
MF-USMF175X*	6	40	1.75	3.50	0.020	0.090	8.00	1.00	0.7

* CSA approval pending.

Environmental Characteristics

Operating Temperature-40 °C to +85 °C
 Maximum Device Surface Temperature
 in Tripped State125 °C
 Passive Aging.....+85 °C, 1000 hours±5 % typical resistance change
 Humidity Aging.....+85 °C, 85 % R.H. 1000 hours±5 % typical resistance change
 Thermal Shock.....+85 °C to -40 °C, 20 times±10 % typical resistance change
 Solvent ResistanceMIL-STD-202, Method 215No change
 VibrationMIL-STD-883C, Method 2007.1,No change
 Condition A

Test Procedures And Requirements For Model MF-USMF Series

Test	Test Conditions	Accept/Reject Criteria
Visual/Mech.....	Verify dimensions and materials	Per MF physical description
Resistance	In still air @ 23 °C.....	R _{min} ≤ R ≤ R _{1max}
Time to Trip	At specified current, V _{max} , 23 °C	T ≤ max. time to trip (seconds)
Hold Current	30 min. at I _{hold}	No trip
Trip Cycle Life	V _{max} , I _{max} , 100 cycles.....	No arcing or burning
Trip Endurance.....	V _{max} , 48 hours	No arcing or burning
Solderability	ANSI/J-STD-002	95 % min. coverage
UL File Number.....	E174545 http://www.ul.com/ Follow link to Certifications, then UL File No., enter E174545	
CSA File Number	CA110338 http://directories.csa-international.org/ Under "Certification Record" and "File Number" enter 110338-0-000	
TÜV Certificate Number	R 02057213 http://www.tuvdotcom.com/ Follow link to "other certificates", enter File No. 2057213	

*RoHS Directive 2002/95/EC Jan 27 2003 including Annex
 Specifications are subject to change without notice.
 Customers should verify actual device performance in their specific applications.

MF-USMF Series - PTC Resettable Fuses

BOURNS®

Product Dimensions

Model	A		B		C		D
	Min.	Max.	Min.	Max.	Min.	Max.	Min.
MF-USMF005	3.00 (0.118)	3.43 (0.135)	2.35 (0.093)	2.80 (0.110)	0.80 (0.031)	1.1 (0.043)	0.30 (0.012)
MF-USMF010	3.00 (0.118)	3.43 (0.135)	2.35 (0.093)	2.80 (0.110)	0.80 (0.031)	1.1 (0.043)	0.30 (0.012)
MF-USMF020	3.00 (0.118)	3.43 (0.135)	2.35 (0.093)	2.80 (0.110)	0.80 (0.031)	1.1 (0.043)	0.30 (0.012)
MF-USMF035	3.00 (0.118)	3.43 (0.135)	2.35 (0.093)	2.80 (0.110)	0.55 (0.022)	0.85 (0.033)	0.30 (0.012)
MF-USMF050	3.00 (0.118)	3.43 (0.135)	2.35 (0.093)	2.80 (0.110)	0.55 (0.022)	0.85 (0.033)	0.30 (0.012)
MF-USMF075	3.00 (0.118)	3.43 (0.135)	2.35 (0.093)	2.80 (0.110)	0.55 (0.022)	0.85 (0.033)	0.30 (0.012)
MF-USMF110	3.00 (0.118)	3.43 (0.135)	2.35 (0.093)	2.80 (0.110)	0.55 (0.022)	0.85 (0.033)	0.30 (0.012)
MF-USMF150	3.00 (0.118)	3.43 (0.135)	2.35 (0.093)	2.80 (0.110)	0.40 (0.016)	0.85 (0.033)	0.30 (0.012)
MF-USMF175X	3.00 (0.118)	3.43 (0.135)	2.35 (0.093)	2.80 (0.110)	0.40 (0.016)	0.85 (0.033)	0.30 (0.012)

Packaging: 3000 pcs. per reel.

UNIT = $\frac{\text{MM}}{\text{(INCHES)}}$

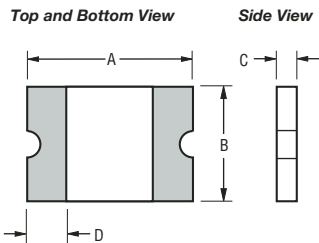

Terminal material:

Electroless Ni under immersion Au

Termination pad solderability:

Standard Au finish:
Meets ANSI/J-STD-002 Category 2.

Recommended Storage:

40 °C max./70 % RH max.

Solder Reflow Recommendations

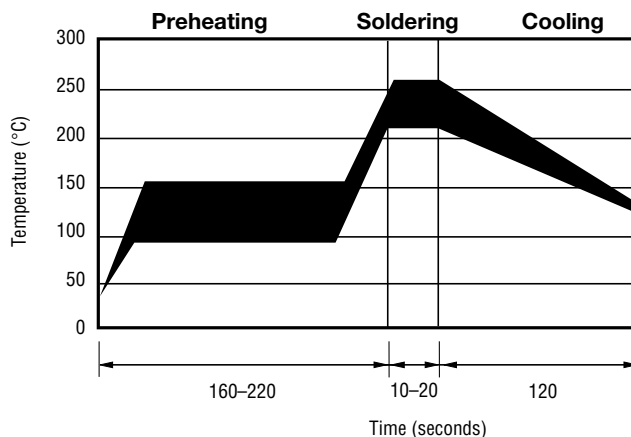

Notes:

- MF-USMF models cannot be wave soldered.
- If reflow temperatures exceed the recommended profile, devices may not meet the performance requirements.
- Compatible with Pb and Pb-free solder reflow profiles.

MF-USMF Series - PTC Resettable Fuses

BOURNS®

Thermal Derating Chart - I_{hold} (Amps)

Model	Ambient Operating Temperature								
	-40 °C	-20 °C	0 °C	23 °C	40 °C	50 °C	60 °C	70 °C	85 °C
MF-USMF005	0.08	0.07	0.06	0.05	0.04	0.04	0.03	0.03	0.02
MF-USMF010	0.15	0.13	0.12	0.10	0.09	0.08	0.07	0.06	0.05
MF-USMF020	0.32	0.28	0.24	0.20	0.18	0.16	0.14	0.12	0.10
MF-USMF035	0.51	0.46	0.40	0.34	0.30	0.27	0.24	0.22	0.18
MF-USMF050	0.76	0.66	0.58	0.48	0.42	0.38	0.35	0.29	0.23
MF-USMF075	1.10	0.97	0.86	0.72	0.64	0.58	0.55	0.47	0.39
MF-USMF110	1.60	1.42	1.26	1.10	0.94	0.86	0.80	0.70	0.58
MF-USMF150	2.30	2.02	1.76	1.43	1.24	1.11	1.00	0.85	0.65
MF-USMF175X	2.80	2.45	2.10	1.75	1.55	1.45	1.35	1.25	1.10

Typical Time to Trip at 23 °C

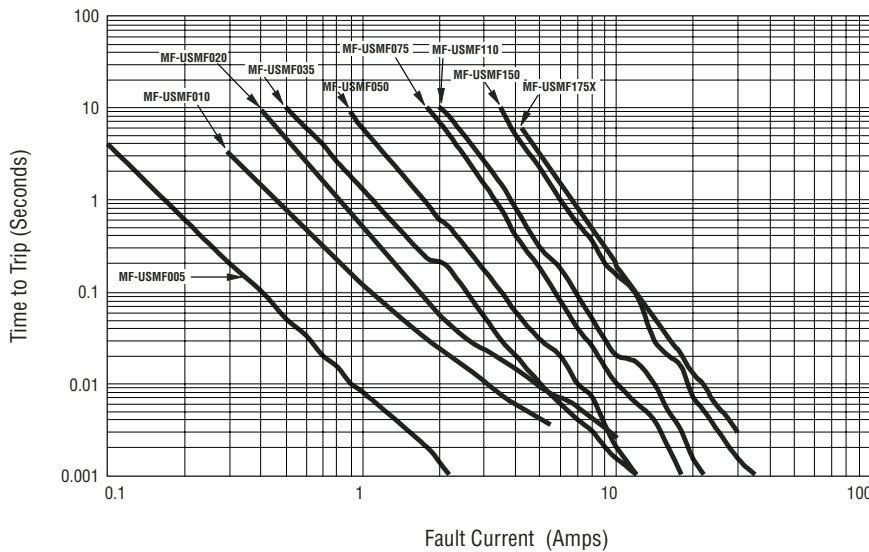

The Time to Trip curves represent typical performance of a device in a simulated application environment. Actual performance in specific customer applications may differ from these values due to the influence of other variables.

How to Order

MF - USMF 010 X - 2

Multifuse® Product Designator

Series _____
 USMF = 1210 Surface Mount Component

Hold Current, I_{hold} _____
 005-175 (0.05-1.75 Amps)

Expansion Free Design _____

Packaging _____
 Packaged per EIA 481-1
 -2 = Tape and Reel

Typical Part Marking

Represents total content. Layout may vary.

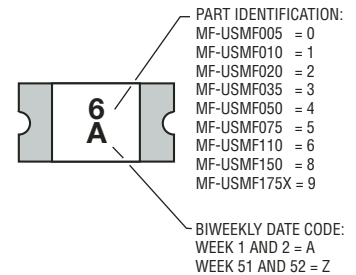

Asia-Pacific:
 Tel: +886-2 2562-4117 • Fax: +886-2 2562-4116

Europe:
 Tel: +41-41 768 5555 • Fax: +41-41 768 5510

The Americas:
 Tel: +1-951 781-5500 • Fax: +1-951 781-5700

www.bourns.com

MF-USMF Series Tape and Reel Specifications



MF-USMF Series per EIA 481-2

Tape Dimensions

W	$\frac{8.0 \pm 0.3}{(0.315 \pm 0.012)}$
P ₀	$\frac{4.0 \pm 0.1}{(0.157 \pm 0.004)}$
P ₁	$\frac{4.0 \pm 0.1}{(0.157 \pm 0.004)}$
P ₂	$\frac{2.0 \pm 0.05}{(0.079 \pm 0.002)}$
A ₀	$\frac{2.76 \pm 0.10}{(0.109 \pm 0.004)}$
B ₀	$\frac{3.50 \pm 0.10}{(0.138 \pm 0.004)}$
B ₁ max.	$\frac{4.35}{(0.171)}$
D ₀	$\frac{1.5 + 0.1/-0.0}{(0.059 + 0.004/-0)}$
F	$\frac{3.5 \pm 0.05}{(0.138 \pm 0.002)}$
E ₁	$\frac{1.75 \pm 0.10}{(0.069 \pm 0.004)}$
E ₂ min.	$\frac{6.25}{(0.246)}$
T max.	$\frac{0.6}{(0.024)}$
T ₁ max.	$\frac{0.1}{(0.004)}$
K ₀	$\frac{1.07 \pm 0.10}{(0.042 \pm 0.004)}$
Leader min.	$\frac{390}{(15.35)}$
Trailer min.	$\frac{160}{(6.30)}$

Reel Dimensions

A max.	$\frac{185}{(7.283)}$
N min.	$\frac{50}{(1.97)}$
W ₁	$\frac{8.4 + 1.5/-0.0}{(0.331 + 0.059/-0.0)}$
W ₂ max.	$\frac{14.4}{(0.567)}$

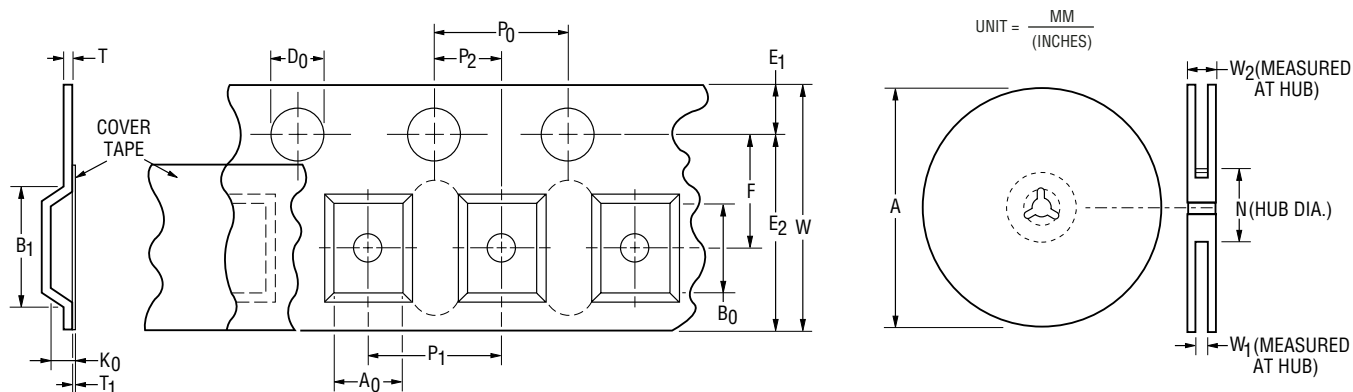

Specifications are subject to change without notice.
Customers should verify actual device performance in their specific applications.