



SATAULC6-2M6 SATAULC6-2P6

Ultra low capacitance ESD protection

Features

- 2-line ESD protection (at 15 kV air and contact discharge, exceeds IEC 61000-4-2)
- Protects V_{BUS} when applicable
- Ultra low capacitance: 0.9 pF @ 825 MHz
- Fast response time
- SOT-666 and μ QFN packages
- RoHS compliant

Benefits

- ESD protection of V_{BUS} when applicable
- Optimized rise and fall times for maximum data integrity
- Large bandwidth to minimize impact on data signal quality
- Consistent differential signal balance:
 - Ultra low impact on intra- and inter-pair skew
 - Matching high bit rate SATA, DVI, HDMI and IEEE 1394 requirements
- Low PCB space occupation - 1.45 mm² for μ QFN
- Low leakage current for longer operation of battery powered devices
- Higher reliability offered by monolithic integration
- Designed for go-through layout

Complies with these standards

- IEC 61000-4-2 level 4
 - 15 kV air discharge
 - 8 kV contact discharge
- MIL STD883G-Method 3015-7

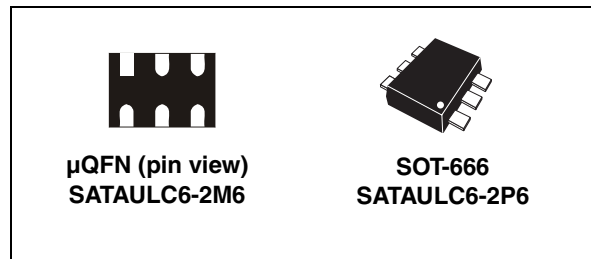

Applications

- SATA port up to 3 Gb/s
- DVI and HDMI ports up to 1.65 Gb/s
- IEEE 1394a and b (Firewire) ports up to 1.6 Gb/s
- USB 2.0 ports up to 480 Mb/s (Hi-Speed), backwards compatible with USB 1.1 low and full speed
- Ethernet port: 10/100/1000 Mb/s
- SIM card protection
- Video line protection
- Portable electronics

Description

The SATAULC6-2x6 is a monolithic, application specific discrete device dedicated to ESD protection of high speed interfaces.

Its very low line capacitance secures a high level of signal integrity. The device topology provides this integrity without compromising the complete protection of ICs against the most stringent ESD strikes.

1 Characteristics

Figure 1. Functional diagram

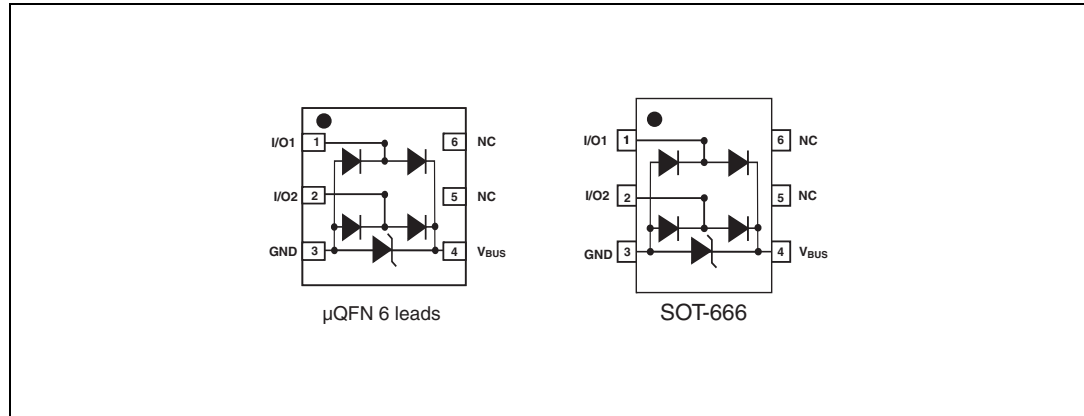

Table 1. Absolute ratings

Symbol	Parameter	Value	Unit	
V _{PP}	Peak pulse voltage	IEC 61000-4-2 air discharge IEC 61000-4-2 contact discharge MIL STD883G-Method 3015-7	±15 ±15 ±25	kV
T _{stg}	Storage temperature range		-55 to +150	°C
T _j	Maximum junction temperature		125	°C
T _L	Lead solder temperature (10 seconds duration)		260	°C

Table 2. Electrical characteristics (T_{amb} = 25 °C)

Symbol	Parameter	Test conditions	Value			Unit
			Min.	Typ.	Max	
I _{RM}	Leakage current	V _{RM} = 5 V			0.5	μA
V _{BR}	Breakdown voltage between V _{BUS} and GND	I _R = 1 mA	6			V
V _{CL}	Clamping voltage	I _{PP} = 1 A, t _p = 8/20 μs Any I/O pin to GND			12	V
		I _{PP} = 5 A, t _p = 8/20 μs Any I/O pin to GND			19	V
C _{i/o-i/o}	Capacitance between I/O	V _R = 0 V, F = 825 MHz GND not connected			0.45	pF
C _{i/o-GND}	Capacitance between I/O and GND	V _R = 0 V, F = 825 MHz Any I/O pin to GND			0.9	pF
ΔC _{i/o-GND}	Capacitance variation between I/O and GND	V _R = 0 V, F = 1 MHz		0.08		pF

Figure 2. Line capacitance versus frequency (typical values) SATAULC6-2M6

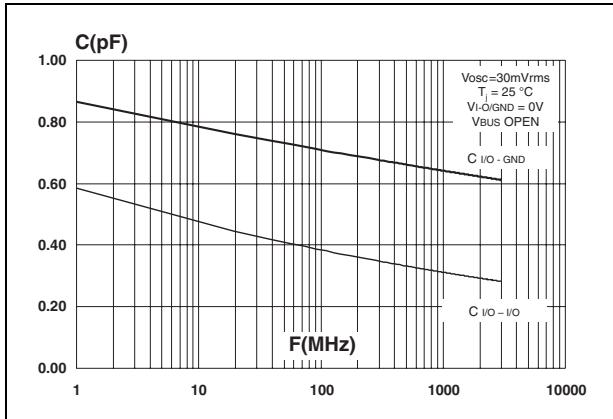

Figure 3. Line capacitance versus frequency (typical values) SATAULC6-2P6

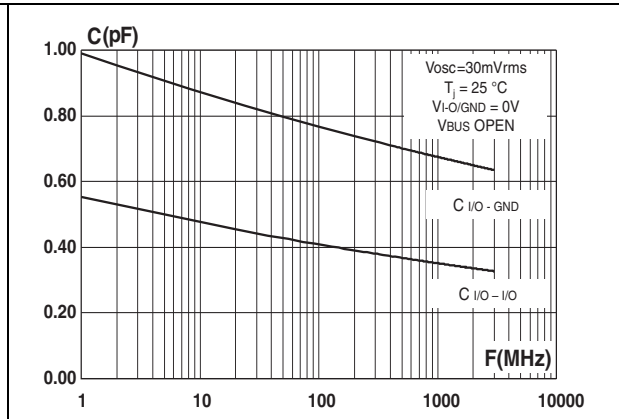

Figure 4. Attenuation (typical values) SATAULC6-2M6

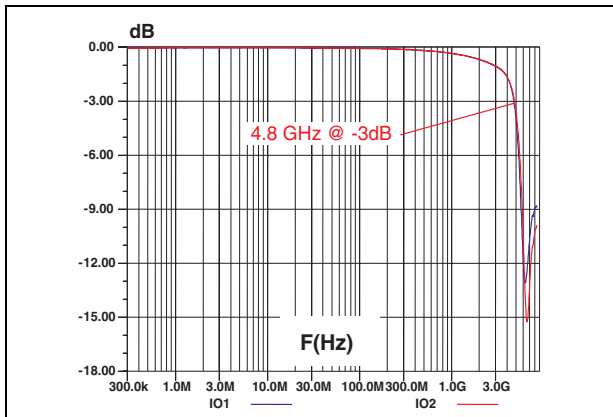

Figure 5. Attenuation (typical values) SATAULC6-2P6

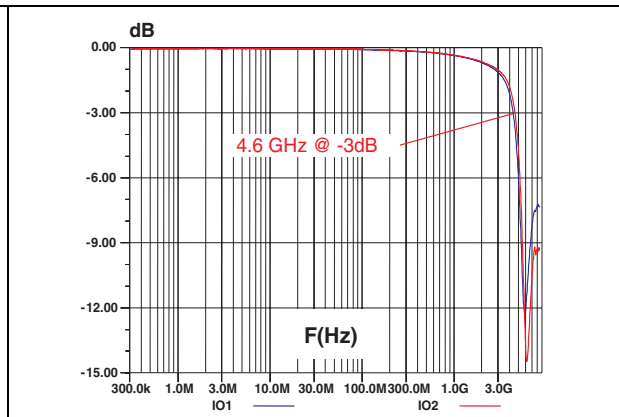

Figure 6. Eye diagram at 1.5 Gbps PCB + SATAULC6-2M6

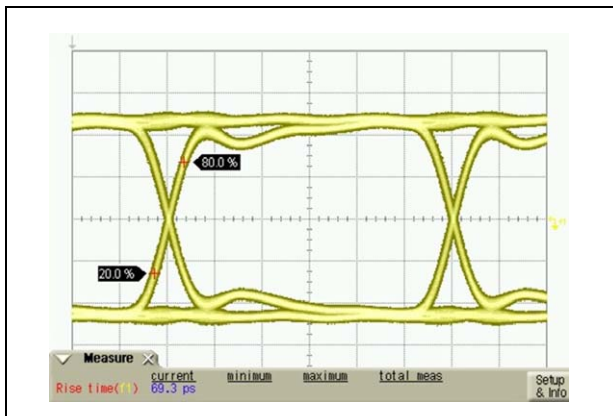

Figure 7. Eye diagram at 1.5 Gbps PCB + SATAULC6-2P6

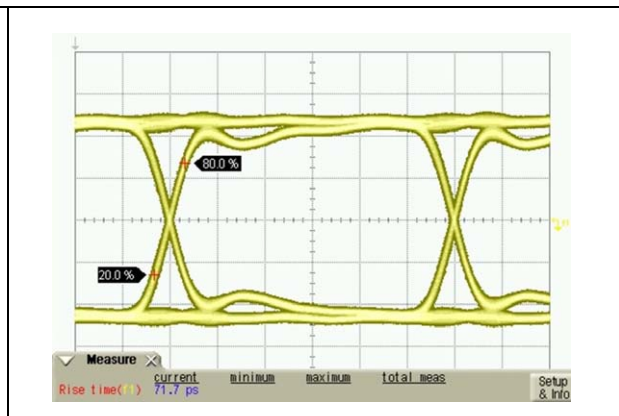

Figure 8. Eye diagram at 1.5 Gbps PCB only

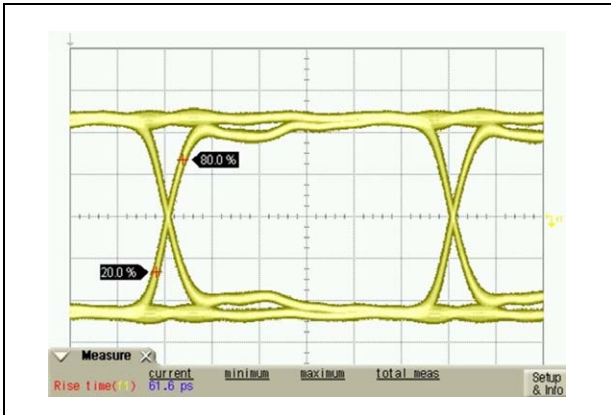

Figure 9. Eye diagram at 3.0 Gbps PCB only

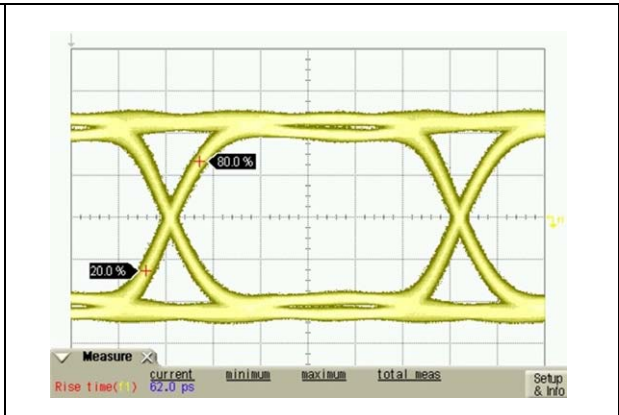

Figure 10. Eye diagram at 3.0 Gbps PCB + SATAULC6-2M6

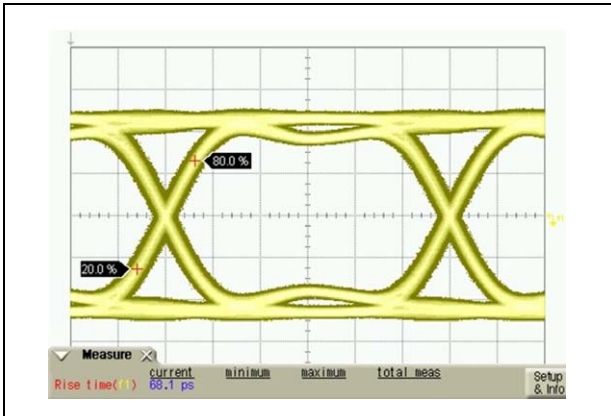
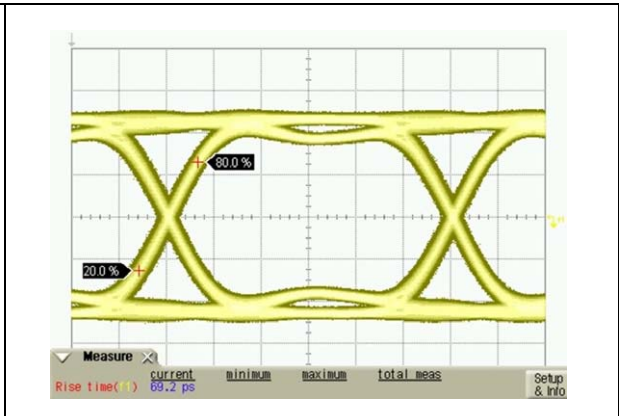
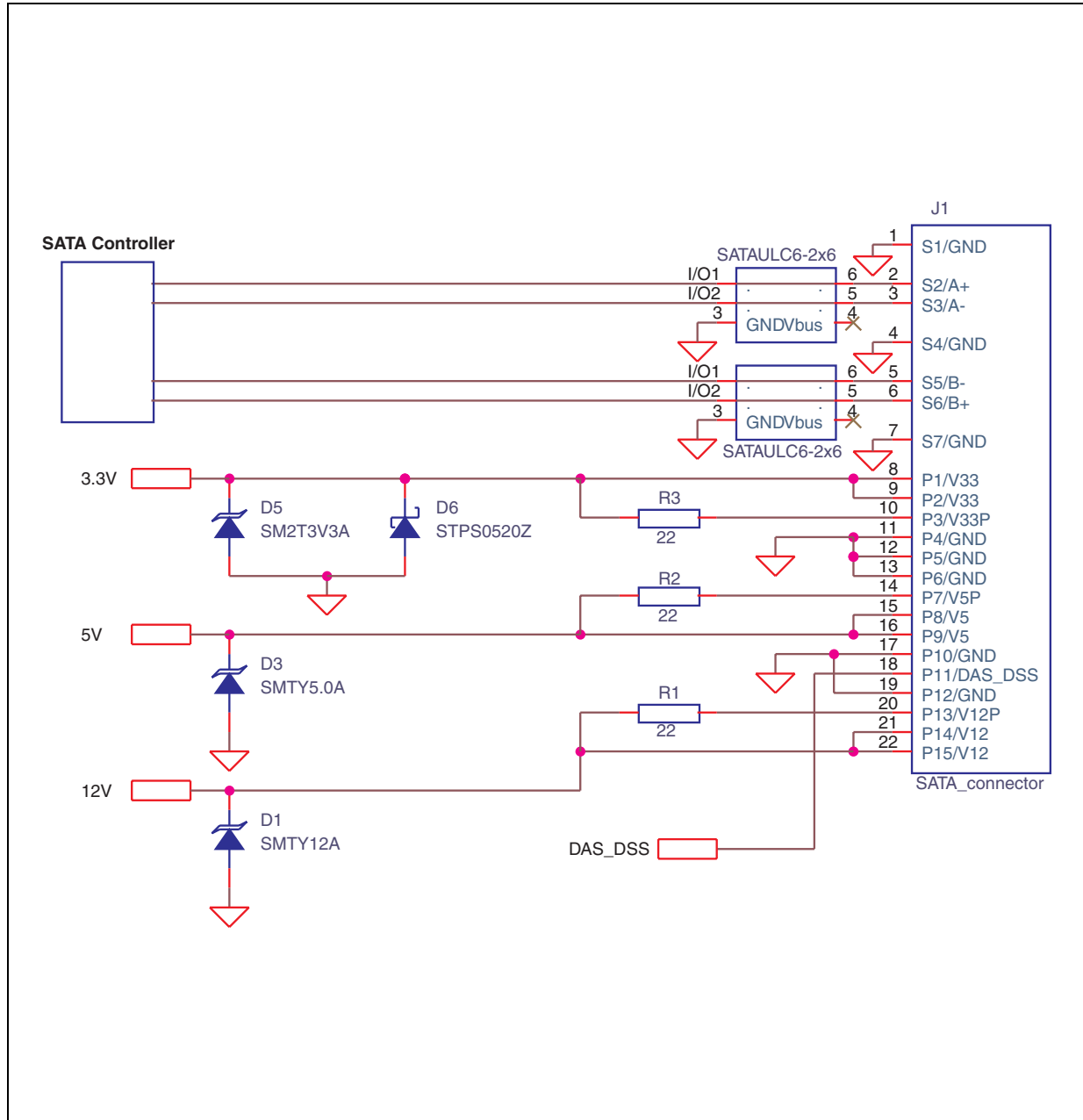

Figure 11. Eye diagram at 3.0 Gbps PCB + SATAULC6-2P6



2 Application example

Figure 12. SATA application using a go-through layout



3 Recommendation on PCB assembly

3.1 Stencil opening design

1. General recommendation on stencil opening design
 - a) Stencil opening dimensions: L (Length), W (Width), T (Thickness)

Figure 13. Stencil opening dimensions

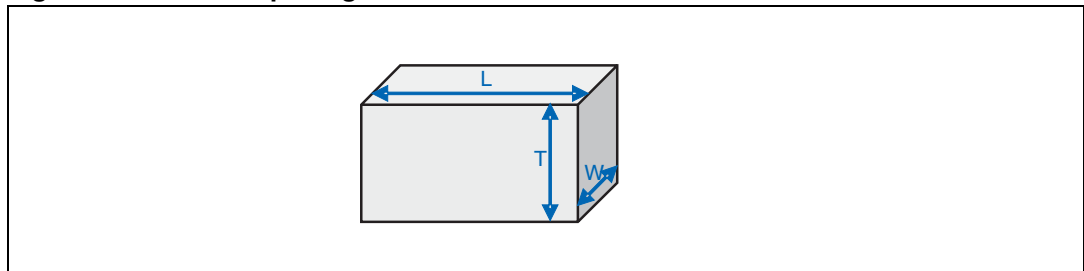

- b) General design rule
 - Stencil thickness (T) = 75 ~ 125 μm
 - Aspect Ratio = $\frac{W}{T} \geq 1.5$
 - Aspect Area = $\frac{L \times W}{2T(L + W)} \geq 0.66$

2. Reference design
 - a) Stencil opening thickness: 100 μm
 - b) Stencil opening for leads: Opening to footprint ratio is 90%.

Figure 14. Recommended stencil window position (μQFN only)

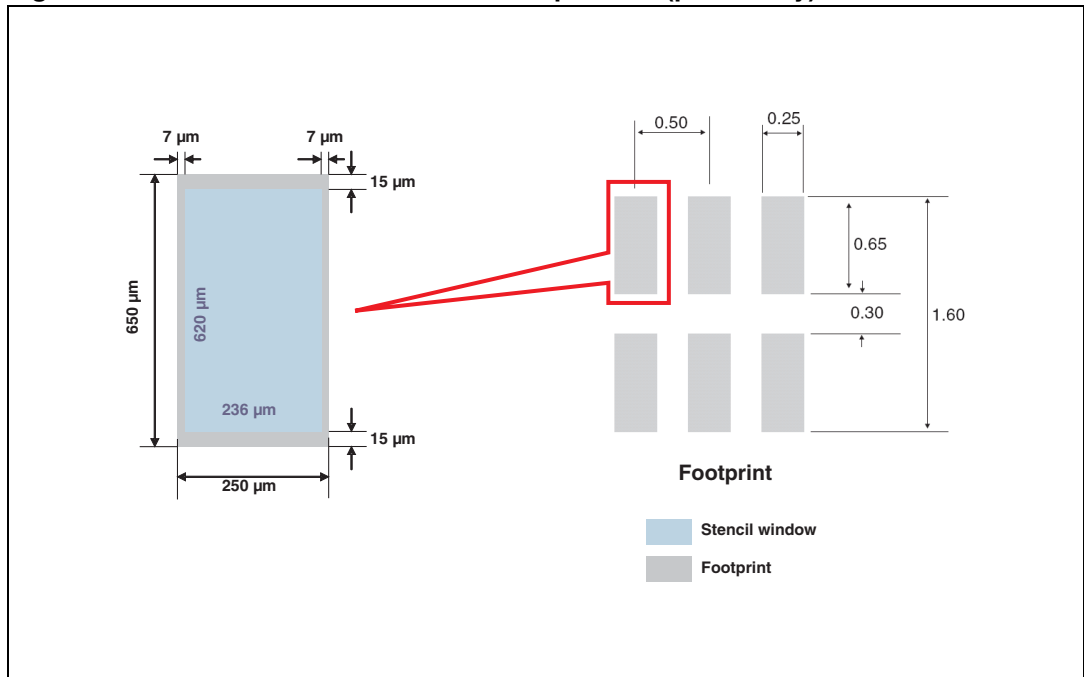

3.2 Solder paste

1. Halide-free flux qualification ROL0 according to ANSI/J-STD-004.
2. “No clean” solder paste is recommended.
3. Offers a high tack force to resist component movement during high speed.
4. Solder paste with fine particles: powder particle size is 20-45 μm .

3.3 Placement

1. Manual positioning is not recommended.
2. It is recommended to use the lead recognition capabilities of the placement system, not the outline centering.
3. Standard tolerance of ± 0.05 mm is recommended.
4. 3.5 N placement force is recommended. Too much placement force can lead to squeezed out solder paste and cause solder joints to short. Too low placement force can lead to insufficient contact between package and solder paste that could cause open solder joints or badly centered packages.
5. To improve the package placement accuracy, a bottom side optical control should be performed with a high resolution tool.
6. For assembly, a perfect supporting of the PCB (all the more on flexible PCB) is recommended during solder paste printing, pick and place and reflow soldering by using optimized tools.

3.4 PCB design preference

1. To control the solder paste amount, the closed via is recommended instead of open vias.
2. The position of tracks and open vias in the solder area should be well balanced. The symmetrical layout is recommended, in case any tilt phenomena caused by asymmetrical solder paste amount due to the solder flow away.

3.5 Reflow profile

Figure 15. ST ECOPACK® recommended soldering reflow profile for PCB mounting

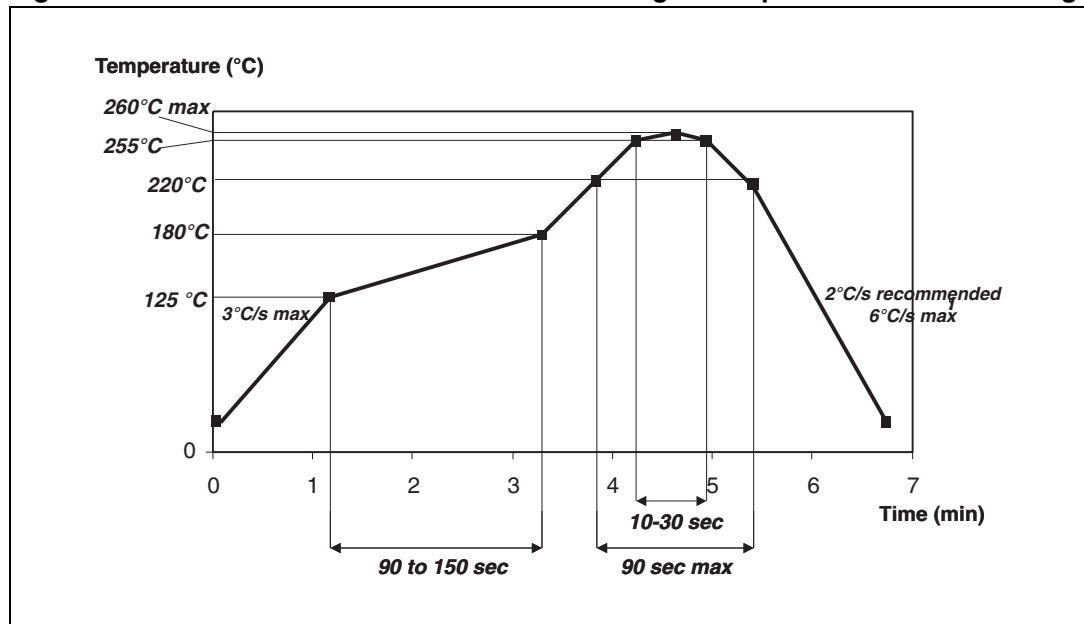

Note: Minimize air convection currents in the reflow oven to avoid component movement.

4 Package information

- Epoxy meets UL94, V0

In order to meet environmental requirements, ST offers these devices in different grades of ECOPACK® packages, depending on their level of environmental compliance. ECOPACK® specifications, grade definitions and product status are available at: www.st.com. ECOPACK® is an ST trademark.

Table 3. Micro QFN 1.45x1.00 6L dimensions

Ref.	Dimensions					
	Millimeters			Inches		
	Min.	Typ.	Max.	Min.	Typ.	Max.
A	0.50	0.55	0.60	0.020	0.022	0.024
A1	0.00	0.02	0.05	0.000	0.001	0.002
b	0.18	0.25	0.30	0.007	0.010	0.012
D		1.45			0.057	
E		1.00			0.039	
e		0.50			0.020	
K	0.20			0.008		
L	0.30	0.35	0.40	0.012	0.014	0.016

Figure 16. μQFN 6 leads footprint dimensions in mm [inches]

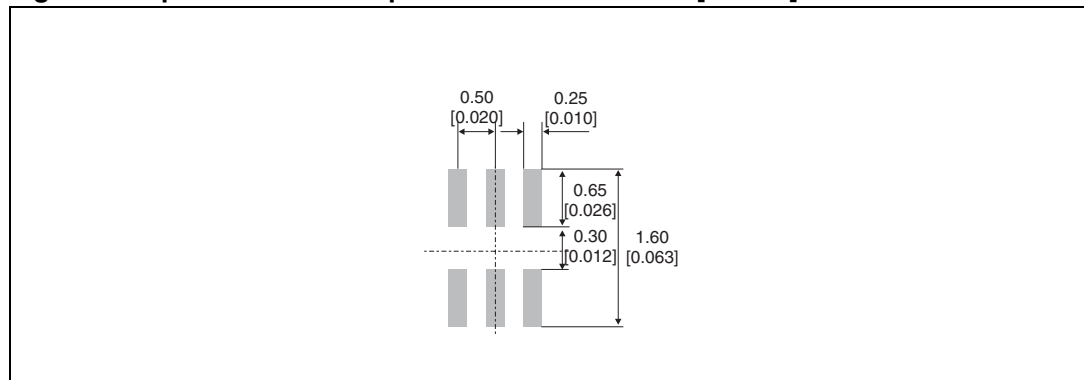

Note: Product marking may be rotated by 90° for assembly plant differentiation. In no case should this product marking be used to orient the component for its placement on a PCB. Only pin 1 mark is to be used for this purpose.

Table 4. SOT-666 dimensions

Ref.	Dimensions					
	Millimeters			Inches		
	Min.	Typ.	Max.	Min.	Typ.	Max.
A	0.45		0.60	0.018		0.024
A3	0.08		0.18	0.003		0.007
b	0.17		0.34	0.007		0.013
b1	0.19	0.27	0.34	0.007	0.011	0.013
D	1.50		1.70	0.059		0.067
E	1.50		1.70	0.059		0.067
E1	1.10		1.30	0.043		0.051
e		0.50			0.020	
L1		0.19			0.007	
L2	0.10		0.30	0.004		0.012
L3		0.10			0.004	

Figure 17. Footprint (dimensions in mm)

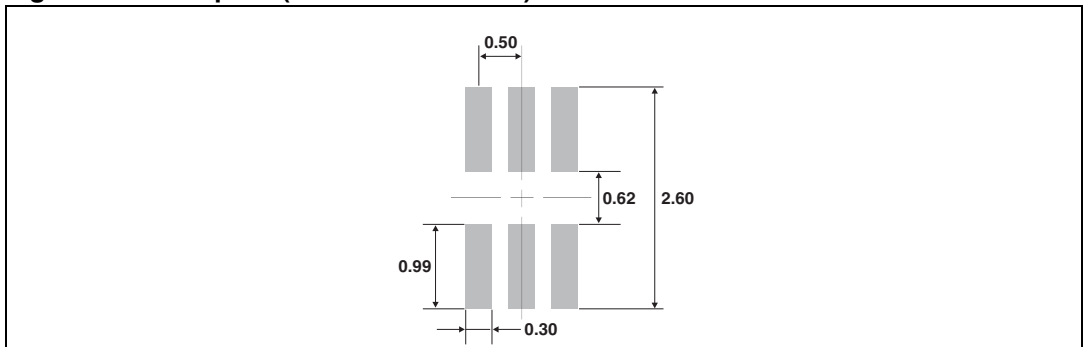

5 Ordering information

Table 5. Ordering information

Order code	Marking	Package	Weight	Base qty	Delivery mode
SATAULC6-2M6	S ⁽¹⁾	μQFN 6 leads	2.17 mg	3000	Tape and reel
SATAULC6-2P6	U	SOT-666	2.99 mg	3000	Tape and reel

1. The marking can be rotated by 90° to differentiate assembly location

6 Revision history

Table 6. Document revision history

Date	Revision	Changes
08-Dec-2008	1	First issue

Please Read Carefully:

Information in this document is provided solely in connection with ST products. STMicroelectronics NV and its subsidiaries ("ST") reserve the right to make changes, corrections, modifications or improvements, to this document, and the products and services described herein at any time, without notice.

All ST products are sold pursuant to ST's terms and conditions of sale.

Purchasers are solely responsible for the choice, selection and use of the ST products and services described herein, and ST assumes no liability whatsoever relating to the choice, selection or use of the ST products and services described herein.

No license, express or implied, by estoppel or otherwise, to any intellectual property rights is granted under this document. If any part of this document refers to any third party products or services it shall not be deemed a license grant by ST for the use of such third party products or services, or any intellectual property contained therein or considered as a warranty covering the use in any manner whatsoever of such third party products or services or any intellectual property contained therein.

UNLESS OTHERWISE SET FORTH IN ST'S TERMS AND CONDITIONS OF SALE ST DISCLAIMS ANY EXPRESS OR IMPLIED WARRANTY WITH RESPECT TO THE USE AND/OR SALE OF ST PRODUCTS INCLUDING WITHOUT LIMITATION IMPLIED WARRANTIES OF MERCHANTABILITY, FITNESS FOR A PARTICULAR PURPOSE (AND THEIR EQUIVALENTS UNDER THE LAWS OF ANY JURISDICTION), OR INFRINGEMENT OF ANY PATENT, COPYRIGHT OR OTHER INTELLECTUAL PROPERTY RIGHT.

UNLESS EXPRESSLY APPROVED IN WRITING BY AN AUTHORIZED ST REPRESENTATIVE, ST PRODUCTS ARE NOT RECOMMENDED, AUTHORIZED OR WARRANTED FOR USE IN MILITARY, AIR CRAFT, SPACE, LIFE SAVING, OR LIFE SUSTAINING APPLICATIONS, NOR IN PRODUCTS OR SYSTEMS WHERE FAILURE OR MALFUNCTION MAY RESULT IN PERSONAL INJURY, DEATH, OR SEVERE PROPERTY OR ENVIRONMENTAL DAMAGE. ST PRODUCTS WHICH ARE NOT SPECIFIED AS "AUTOMOTIVE GRADE" MAY ONLY BE USED IN AUTOMOTIVE APPLICATIONS AT USER'S OWN RISK.

Resale of ST products with provisions different from the statements and/or technical features set forth in this document shall immediately void any warranty granted by ST for the ST product or service described herein and shall not create or extend in any manner whatsoever, any liability of ST.

ST and the ST logo are trademarks or registered trademarks of ST in various countries.

Information in this document supersedes and replaces all information previously supplied.

The ST logo is a registered trademark of STMicroelectronics. All other names are the property of their respective owners.

© 2008 STMicroelectronics - All rights reserved

STMicroelectronics group of companies

Australia - Belgium - Brazil - Canada - China - Czech Republic - Finland - France - Germany - Hong Kong - India - Israel - Italy - Japan - Malaysia - Malta - Morocco - Singapore - Spain - Sweden - Switzerland - United Kingdom - United States of America

www.st.com